



neoVAN-4S Laser Amplifier in O3 and O4

Benno Willke
for the Hannover Laser Team

LVC meeting Lake Geneva 2019 - LIGO-G1900530

Original aLIGO High Power Laser

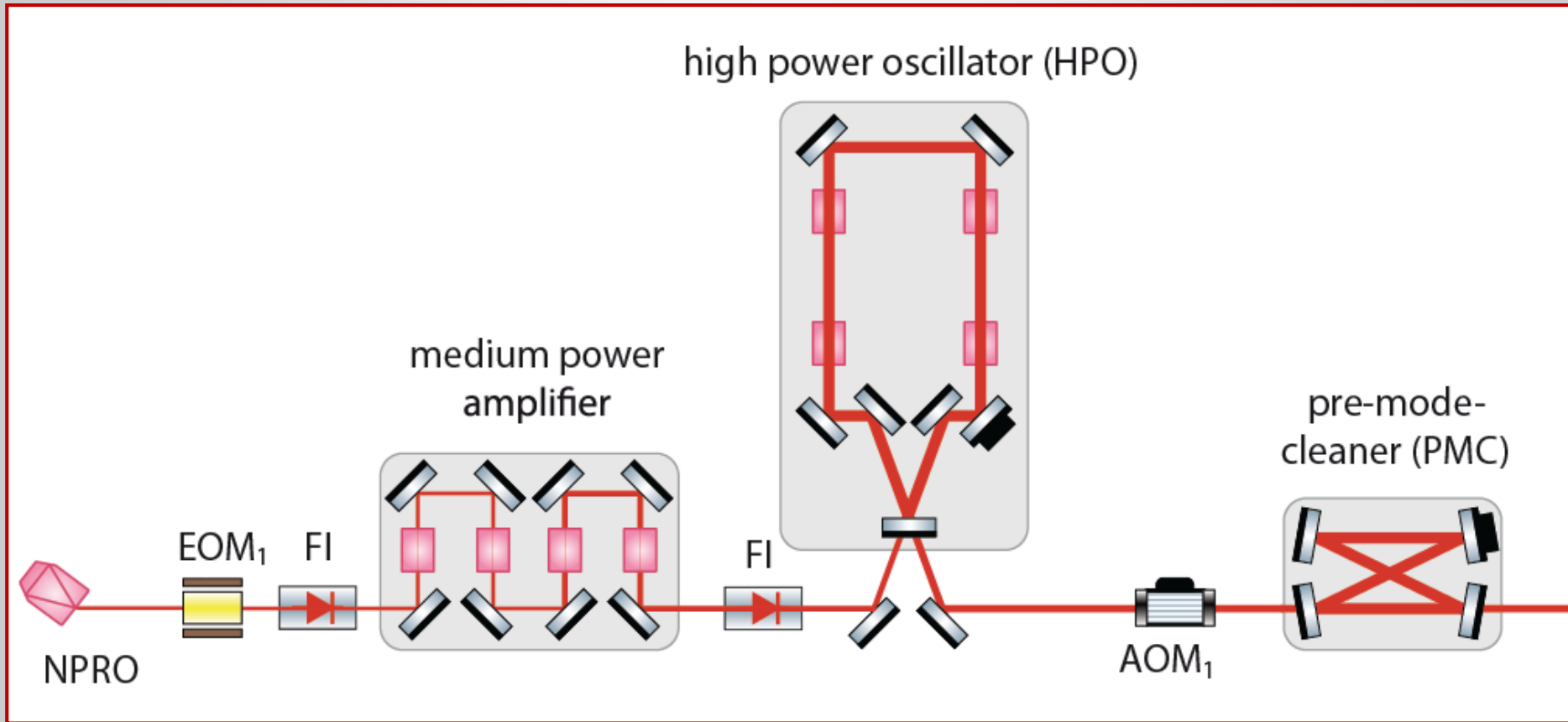

aLIGO PSL: Stabilization Concept

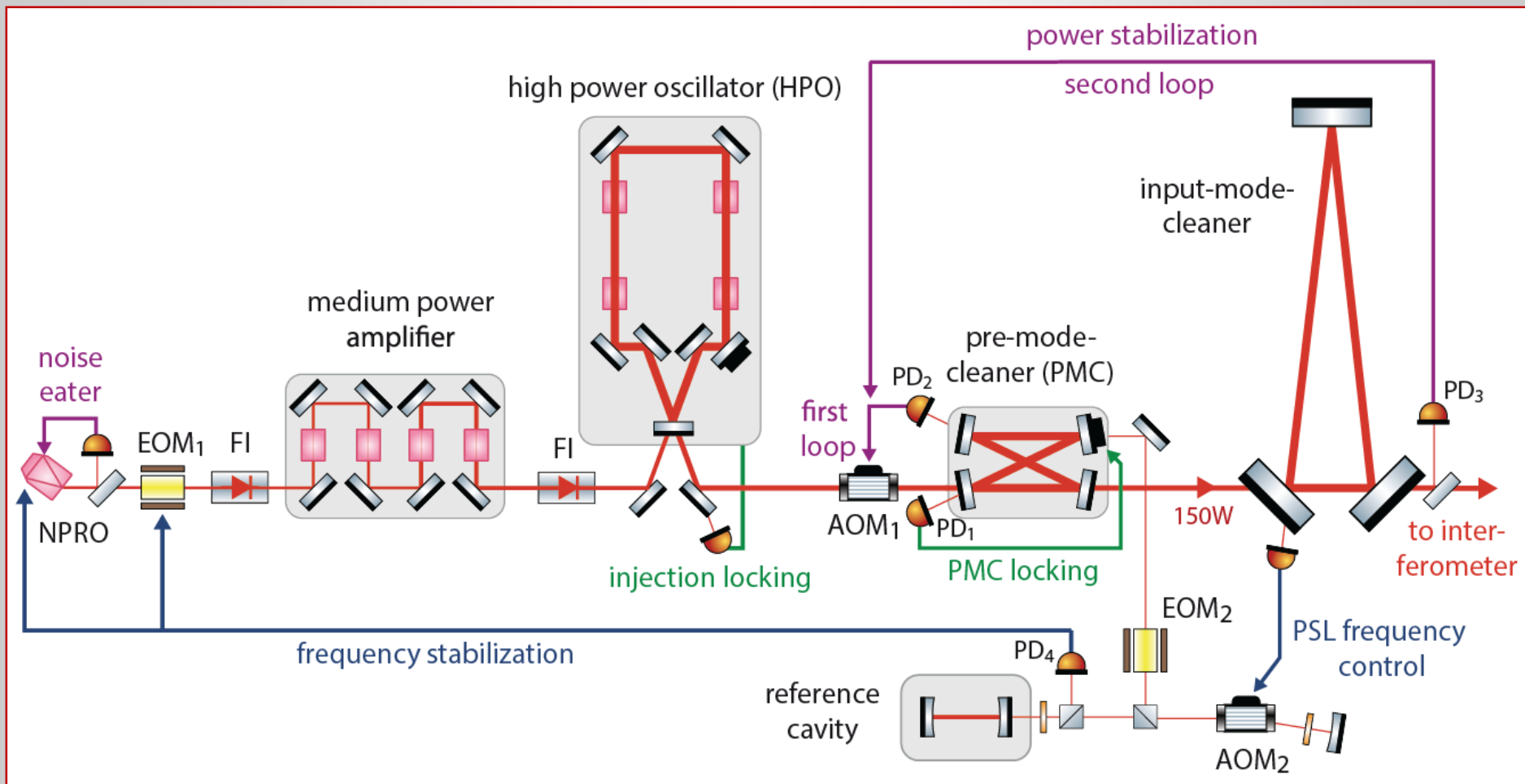

Original aLIGO PSL - Hanford O2

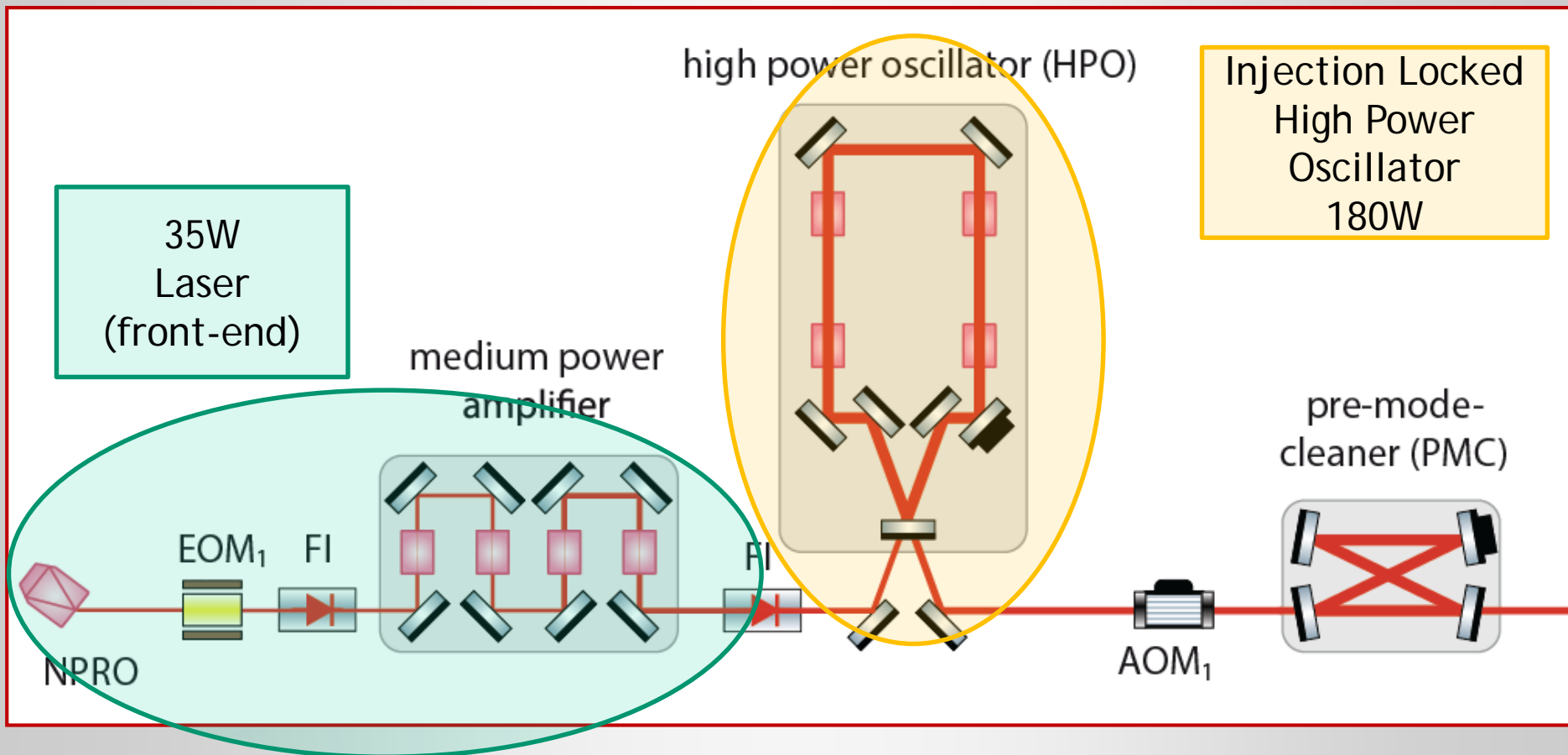

aLIGO PSL - Livingston O2

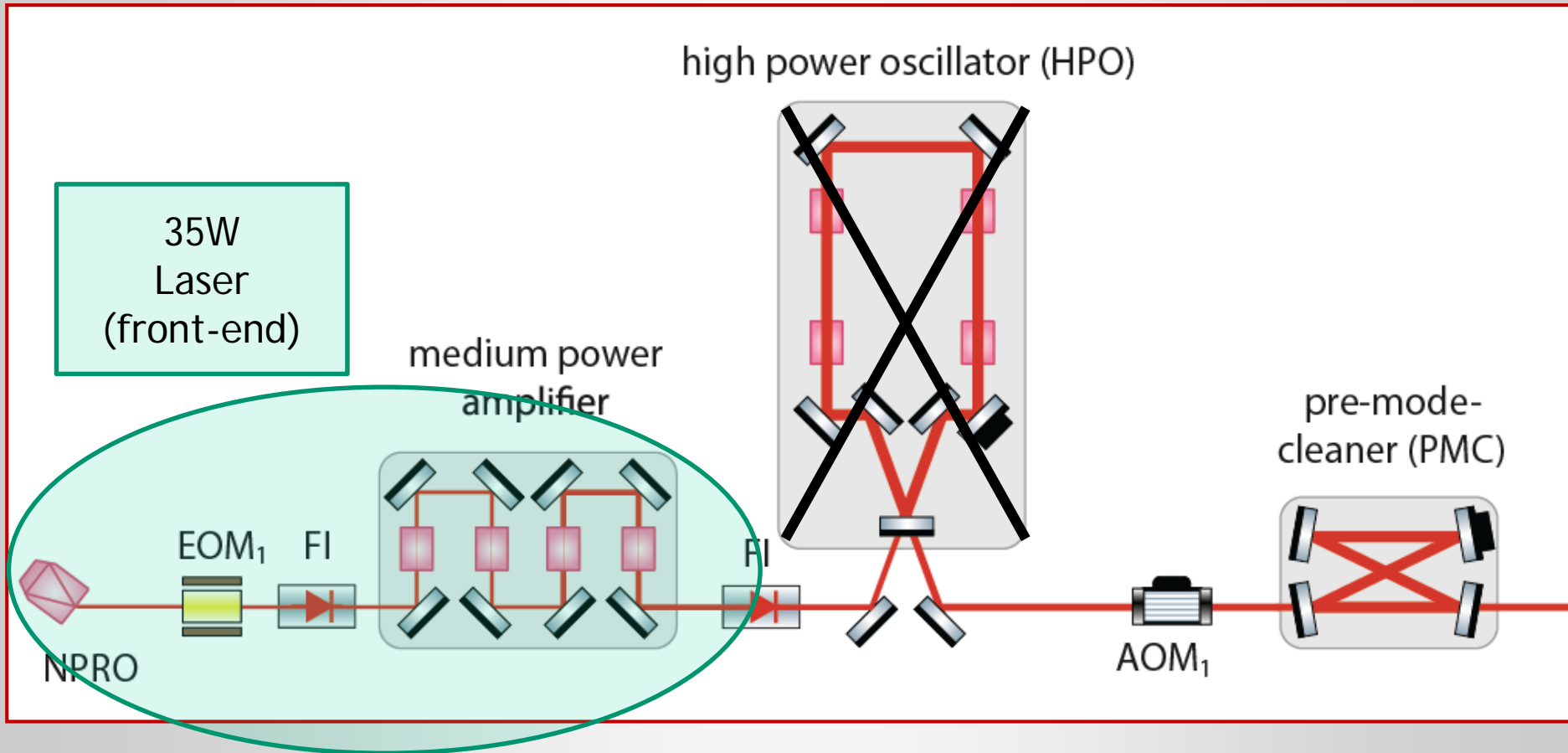

Spatial Fluctuation Coupling in aLIGO O2

- Beam-size-fluctuations and beam jitter limit Hanford O2 sensitivity
- Difference with respect to Livingston:
 - Point defect on IFO mirror
 - Hanford HPO in operation (with strong turbulent water flow)

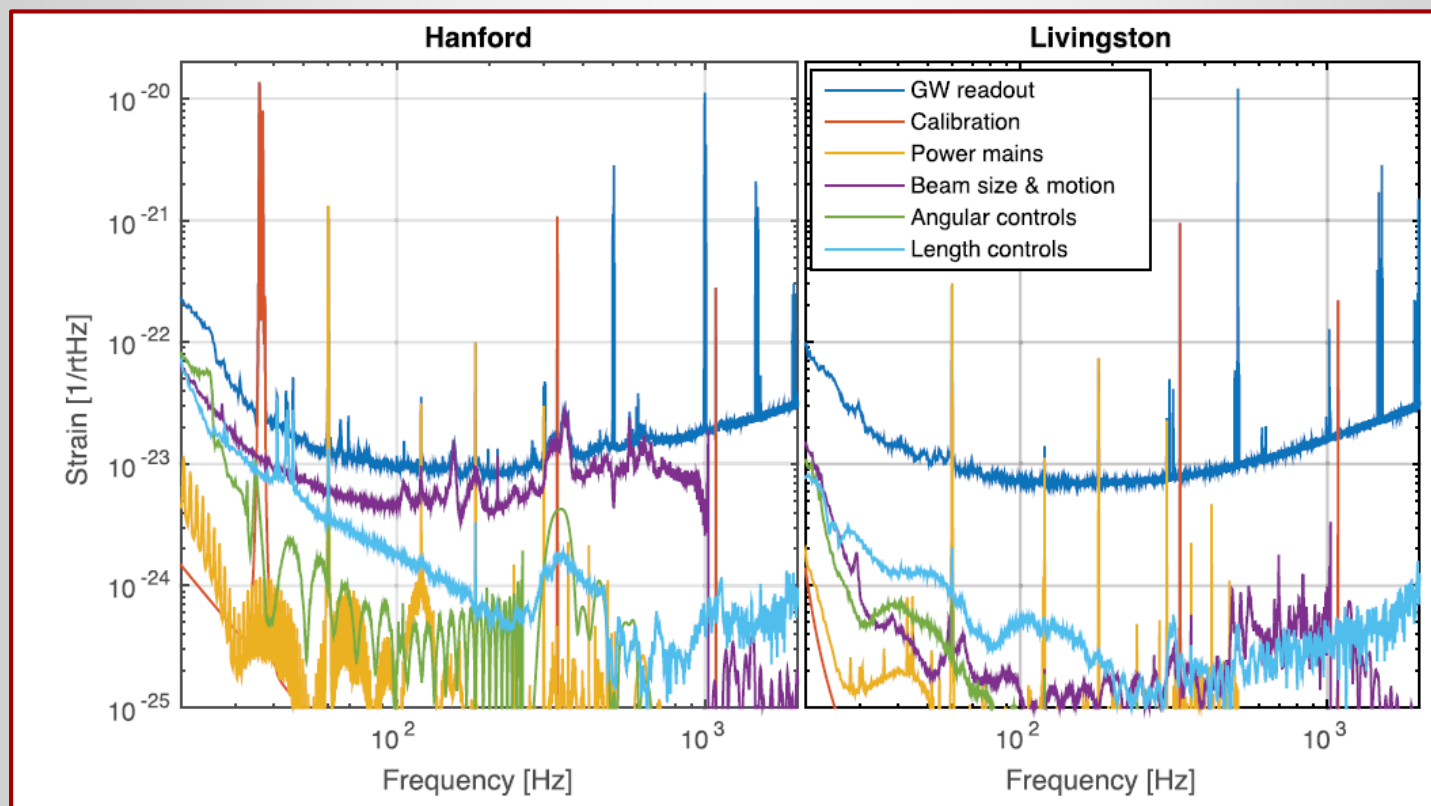

Modified aLIGO PSL for O3

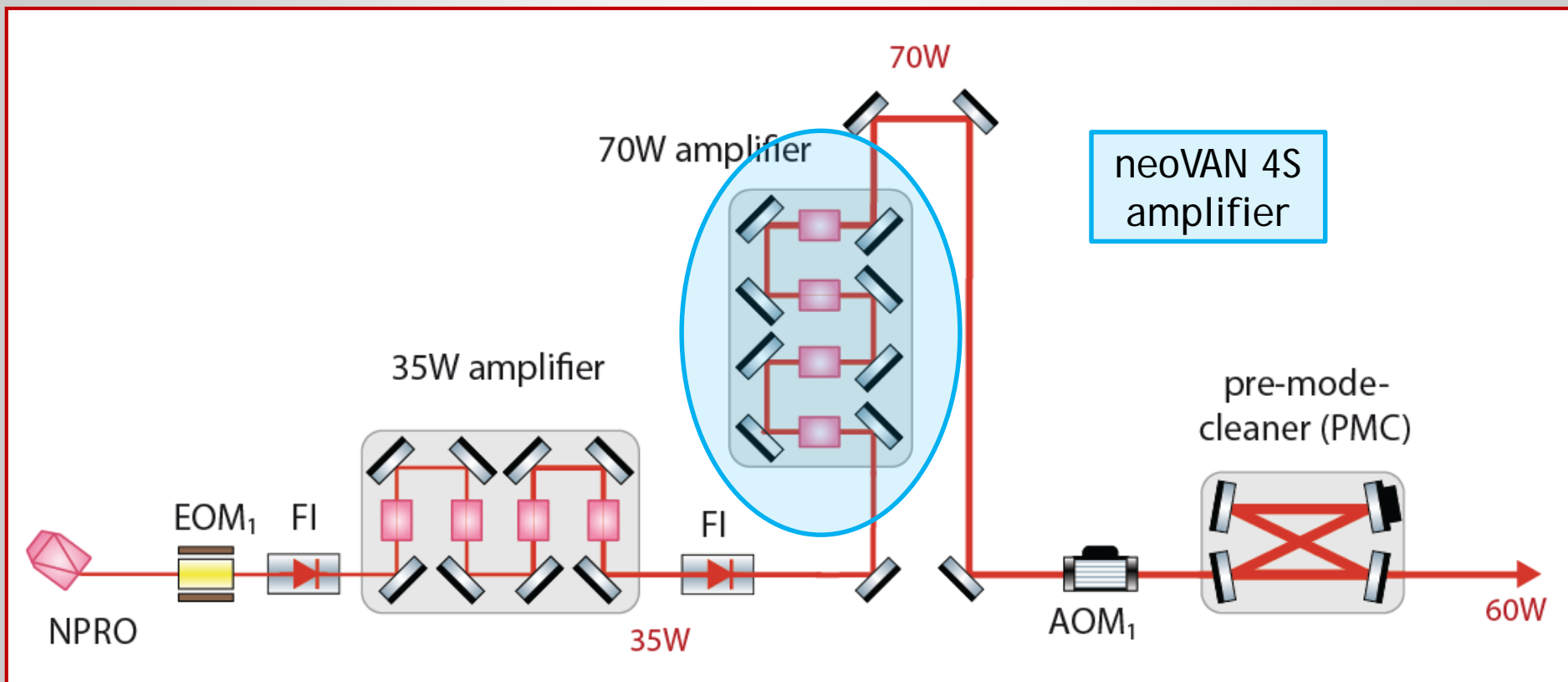

aLIGO PSL - O3 modification

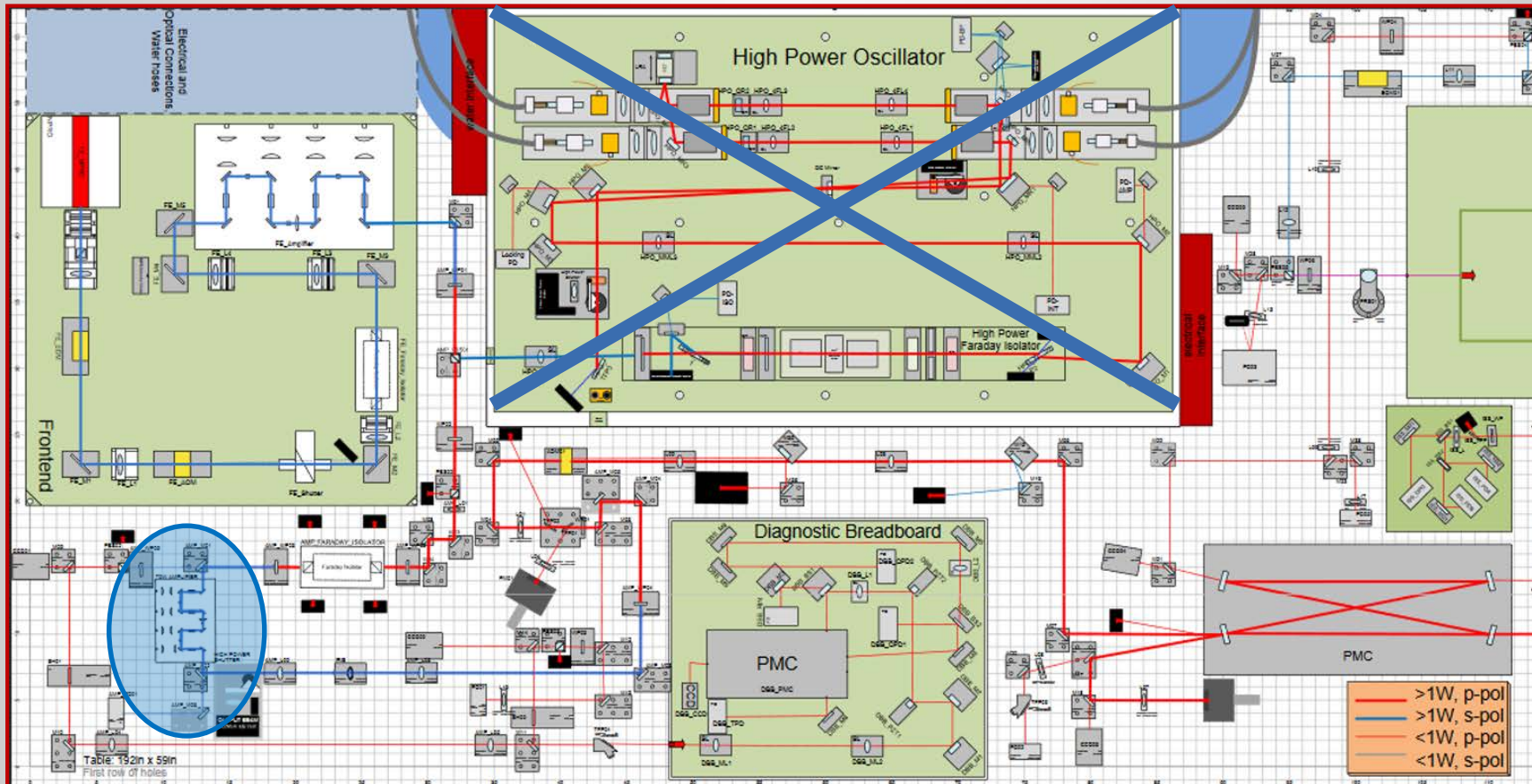

- Tested at aLIGO Reference System at AEI
- All original PSL components stay in place
- 35W front-end beam path is re-routed to neoVAN-4S
- All stabilization loop stay unchanged



70W integration in to aLIGO PSL Reference System

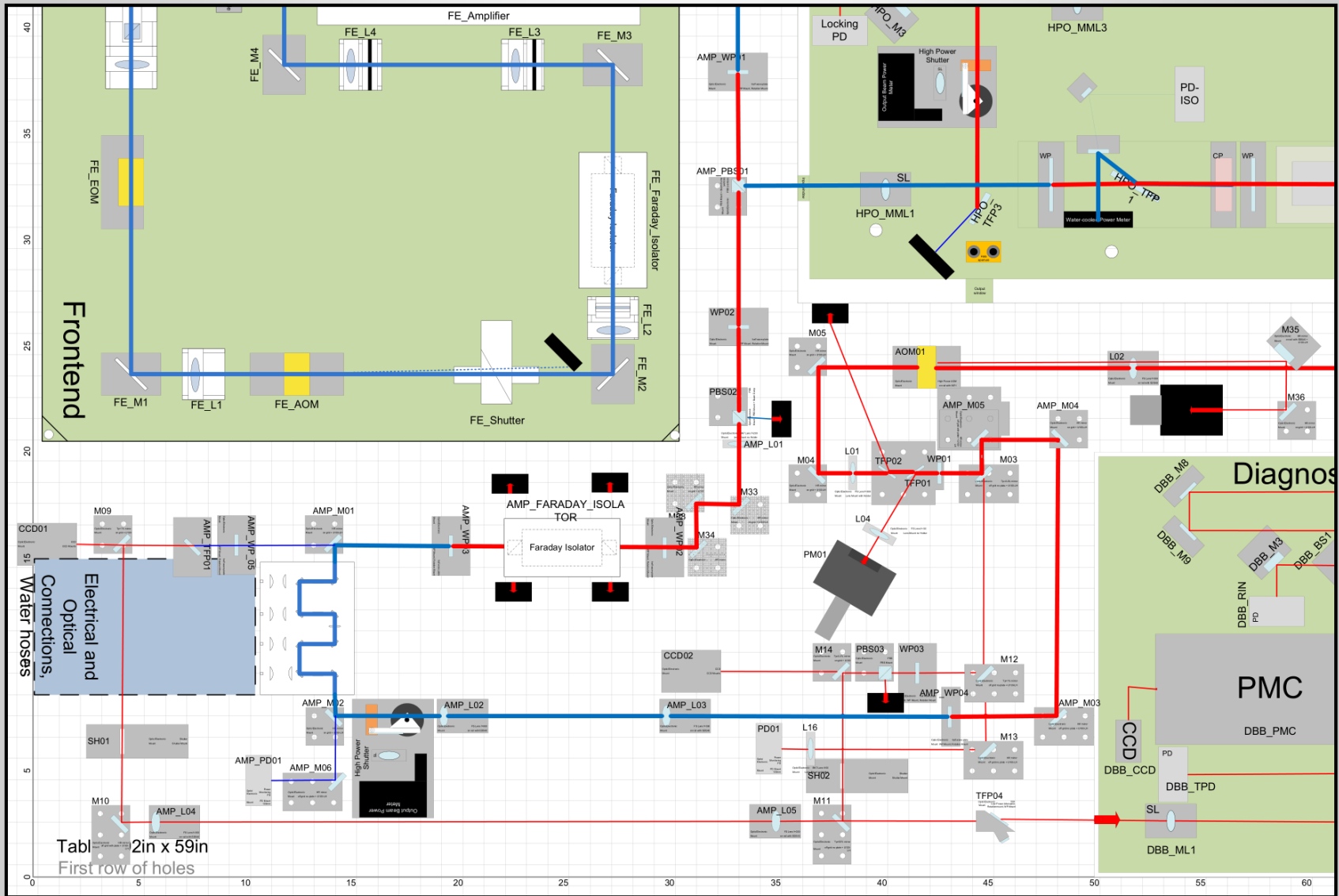

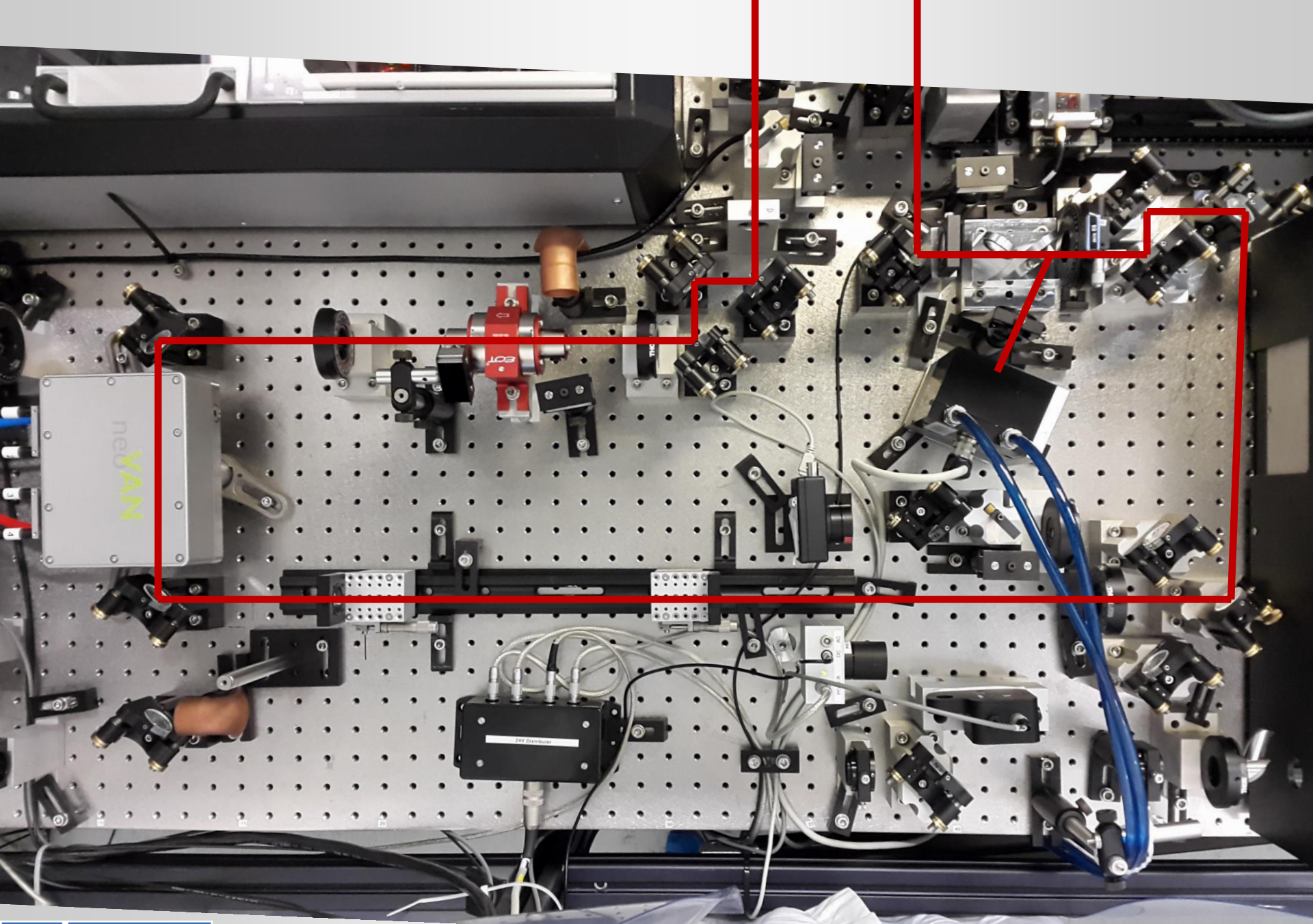

New Generation: neoVAN-4S-HP Amplifier

- First tested for Adv. Virgo at AEI
- Longer pump wavelength
 - 878nm vs. 808nm
 - VBG stabilized pump diodes
- 80W power extraction

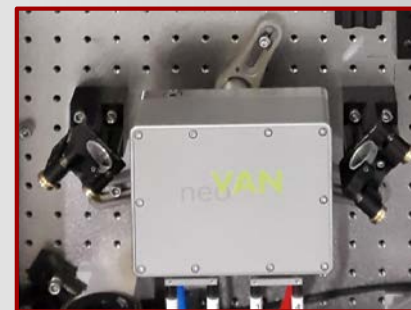
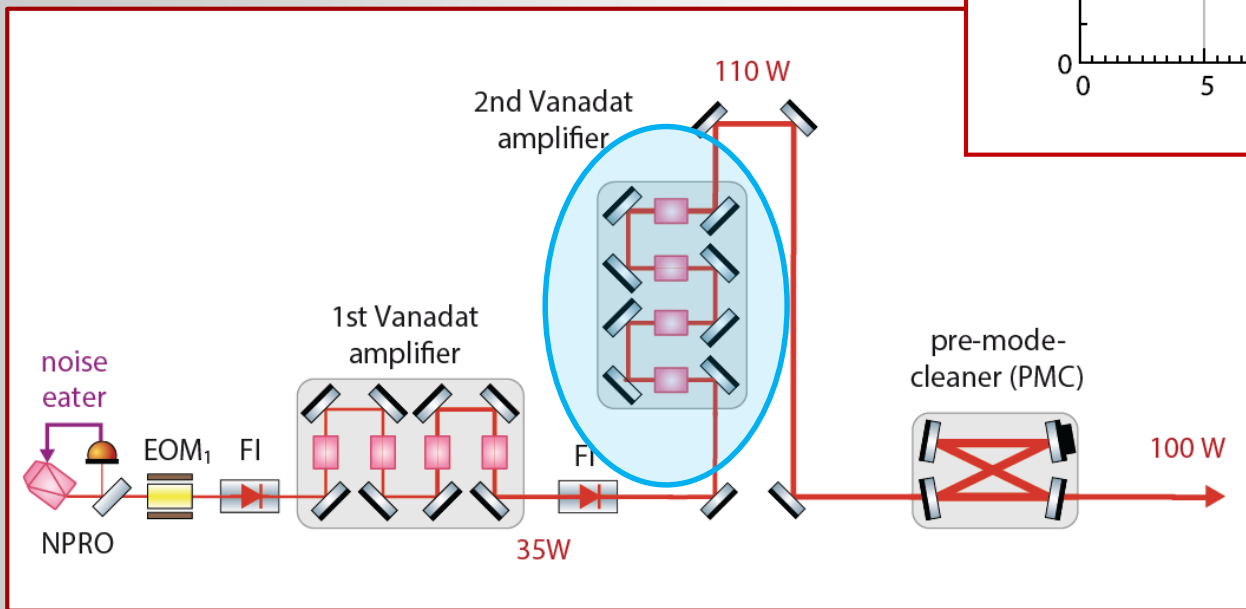
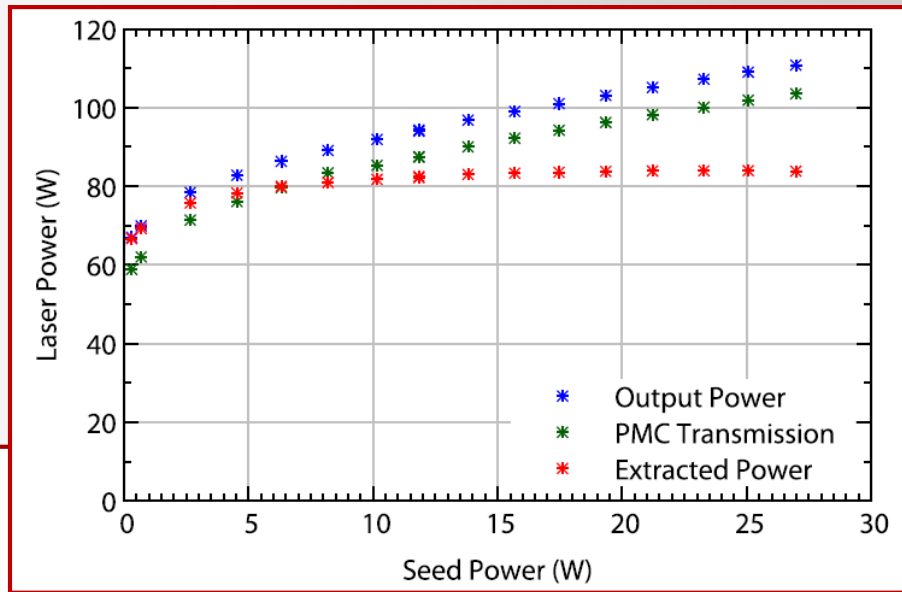

Performance of Nd:Vanadate Amplifier Systems

- Characterization with DBB of AEI aLIGO PSL Reference System
- 114 W output power for 27 W seed
- 3% higher order modes (similar to seed) \Rightarrow 102W after PMC
- Reduces beam pointing wrt. HPL

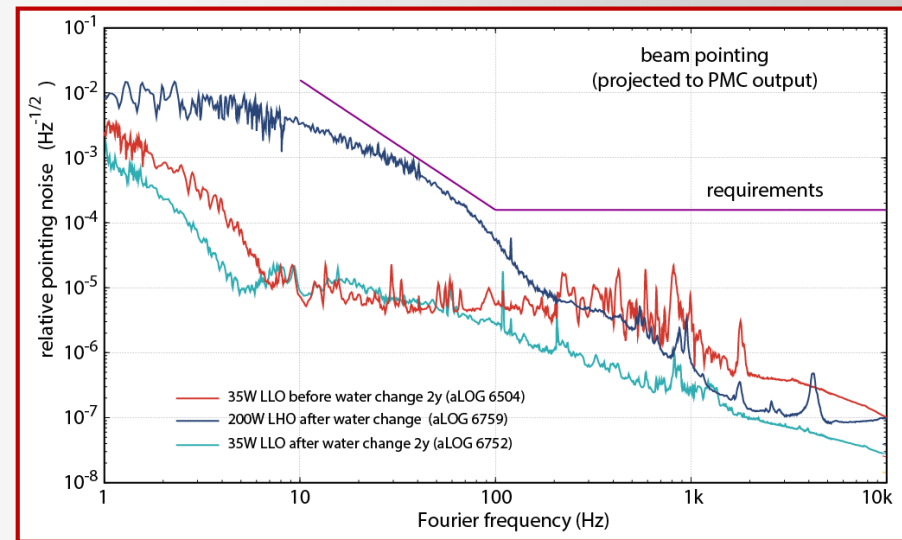
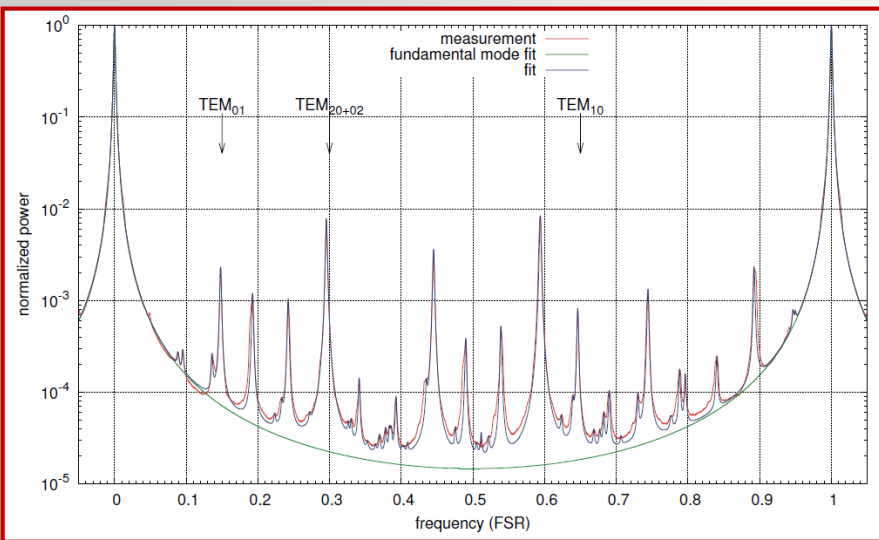
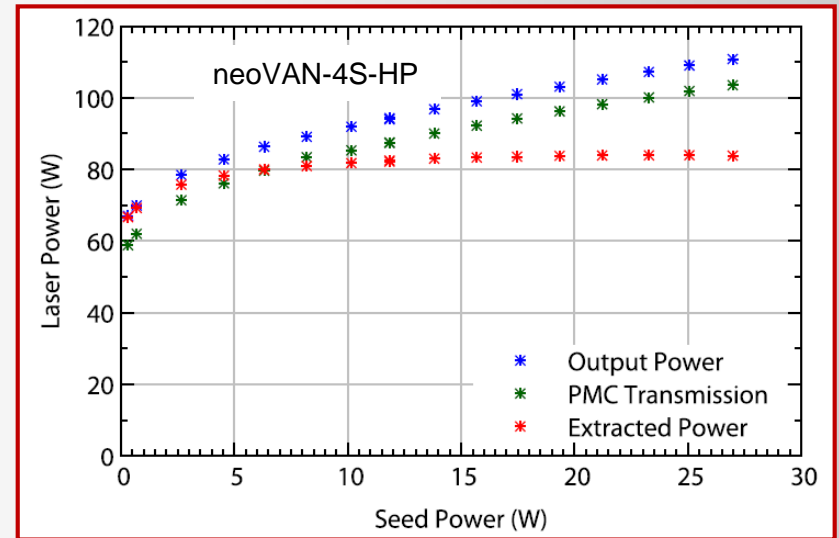

Power Noise and Power Trend of neoVAN Amplifiers

- neoVAN amplifiers have significantly lower power noise than HPO
- Current-shunt in pump diode supply can be used as fast actuator
- 45 day stable operation with cold-start without realignment

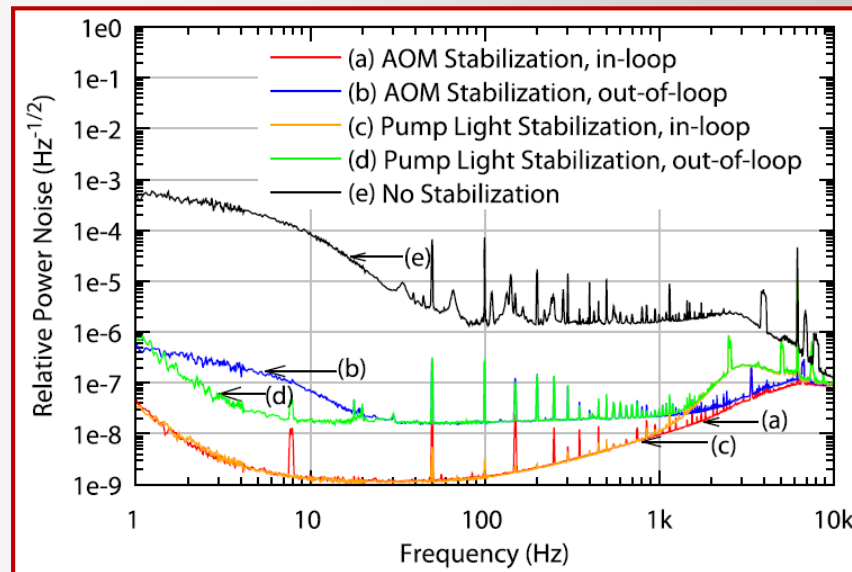
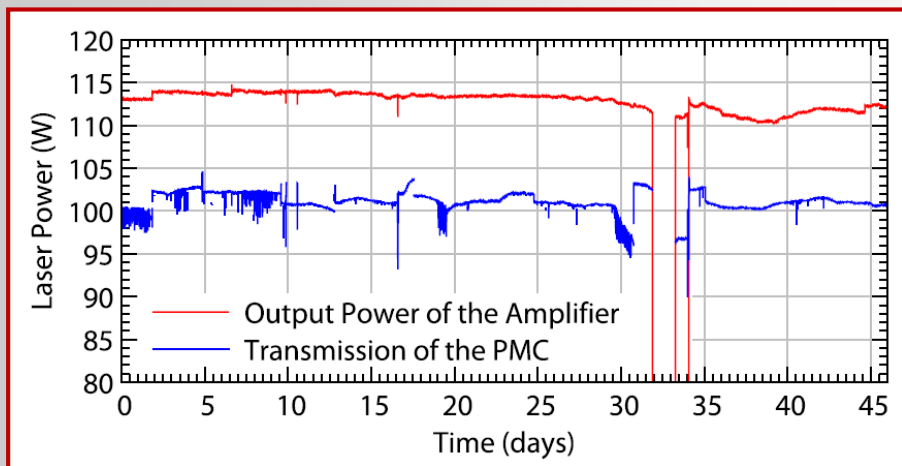
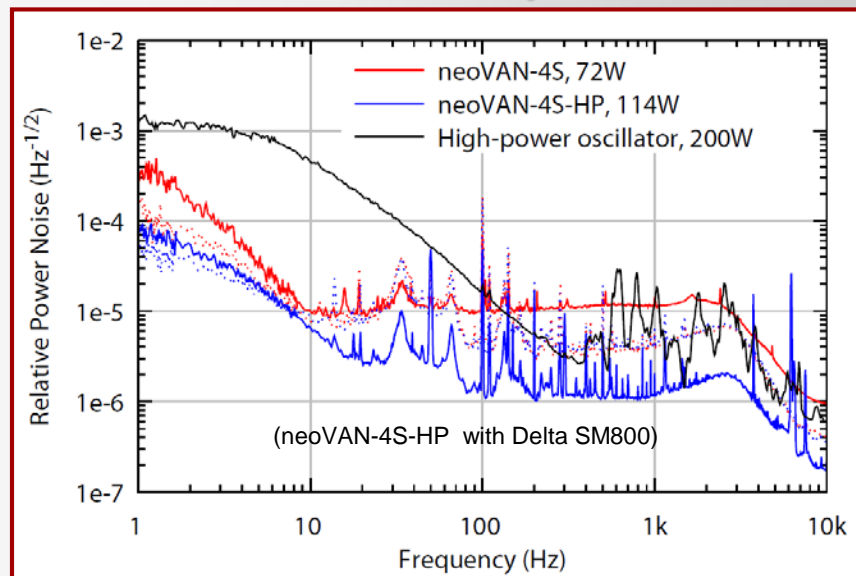

Three Sequential Vanadat Amplifiers

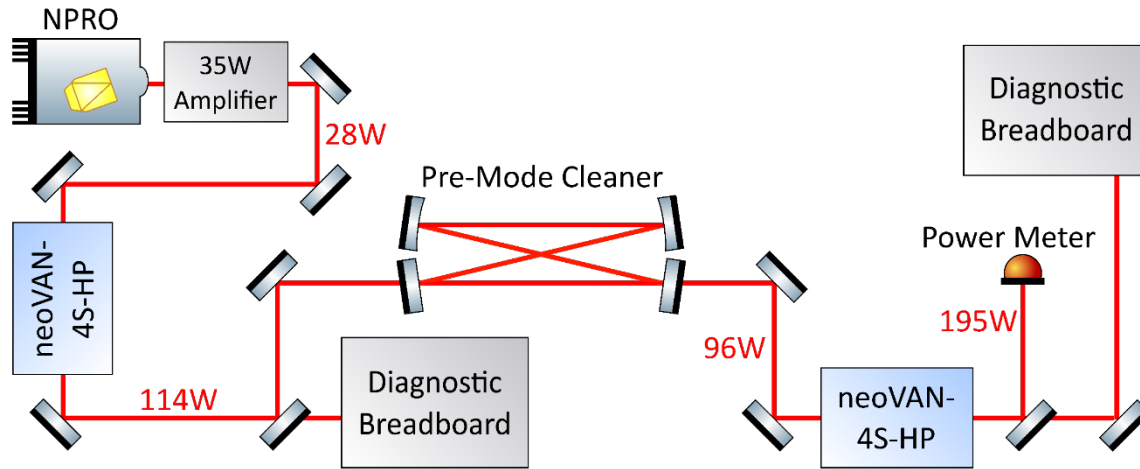

Sequential Vanadat amplifiers deliver 195W

Large higher-order mode content (14%) indicates limit of power scaling

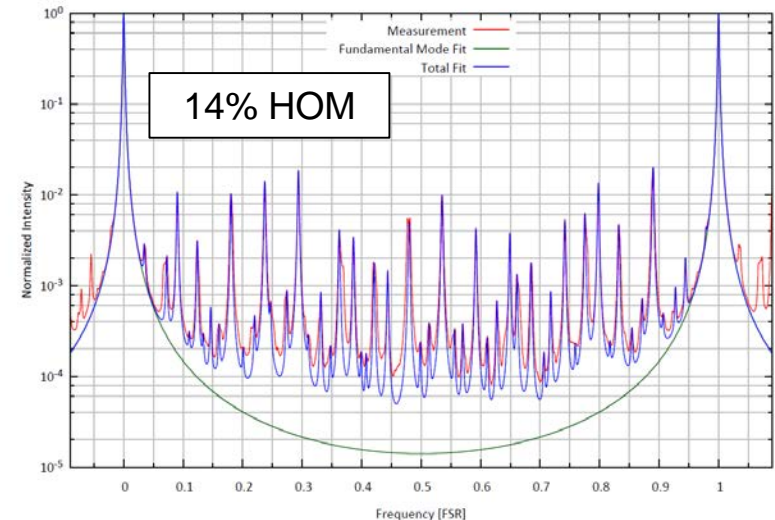
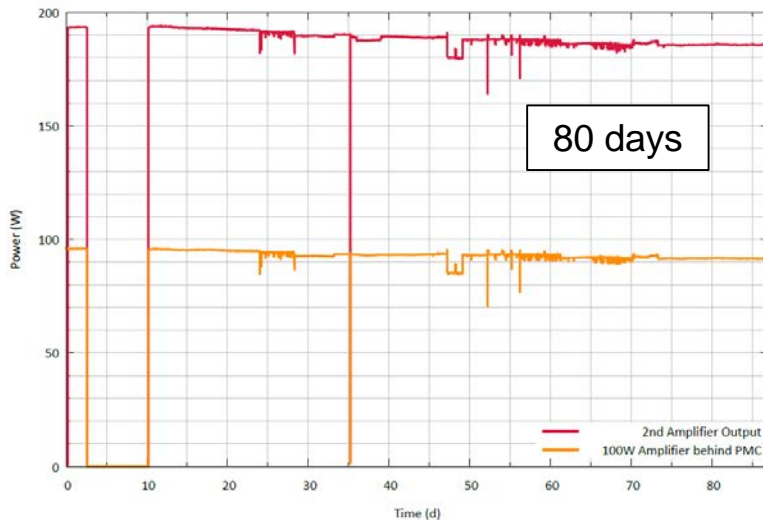

Three Sequential Vanadat Amplifiers - Noise

- Similar pointing noise as two amplifier stage (100W seed filtered by PMC)
- No significant change in frequency noise
- Power noise is seed dominated above 30Hz

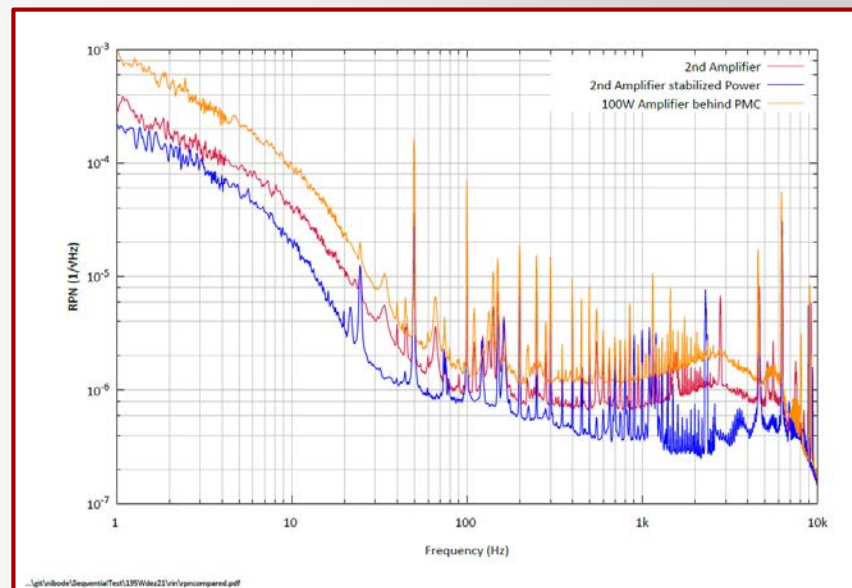
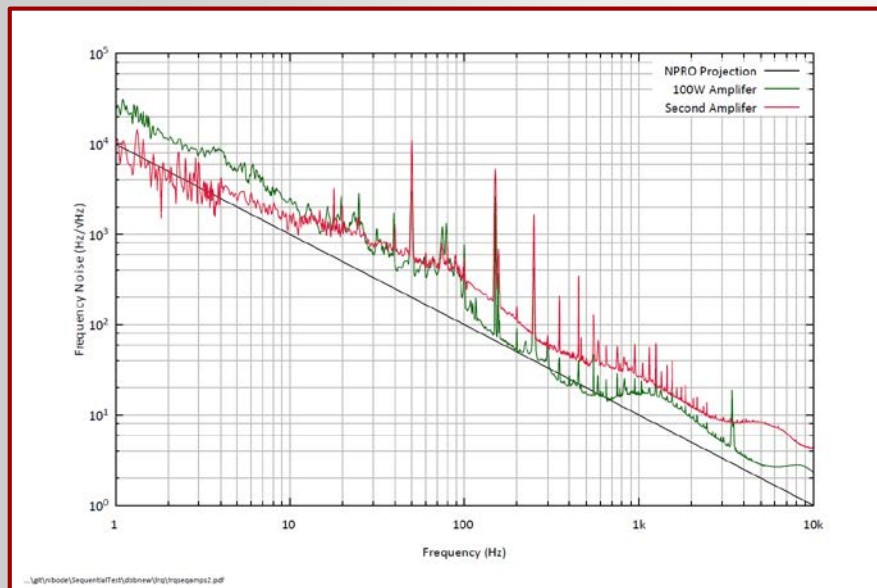
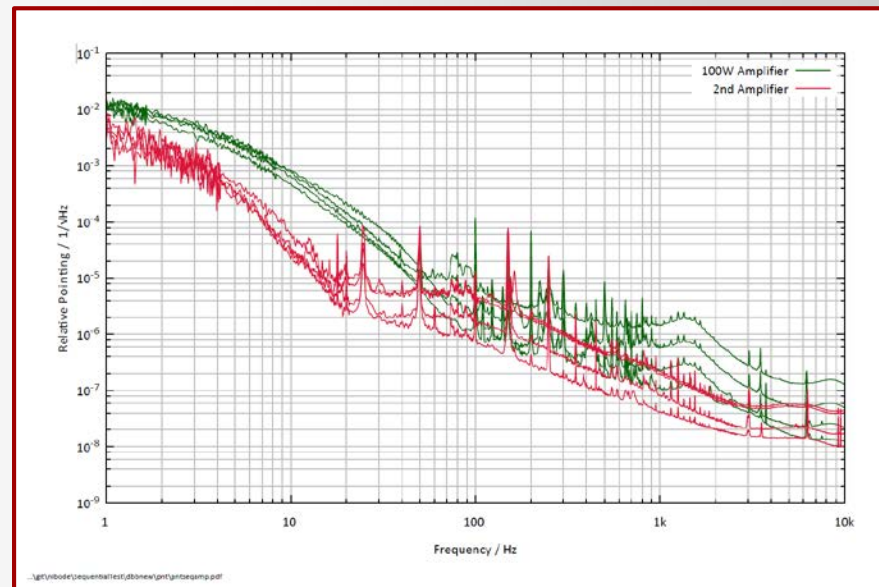

aLIGO PSL - O4 modification

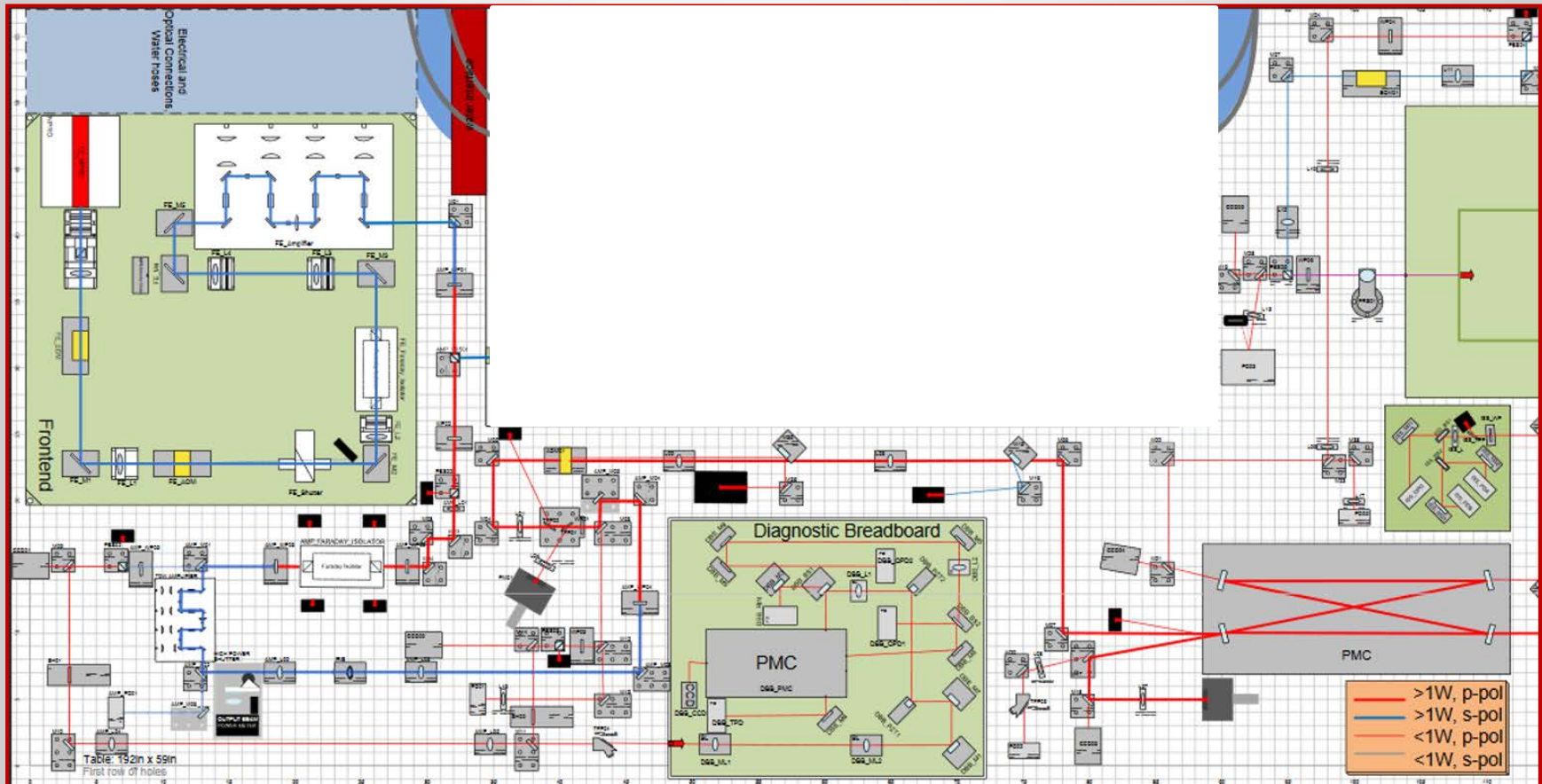

- Take High-Power-Oscillator off the table
- Option 1: amplify 35W front-end by neoVAN-4S-HP amplifier(s)
- Option 2: amplify 2W NPRO by two neoVAN-4S-HP amplifier
- To be developed and tested at TT-Lab (LLO)



O4 Laser System: Option 1

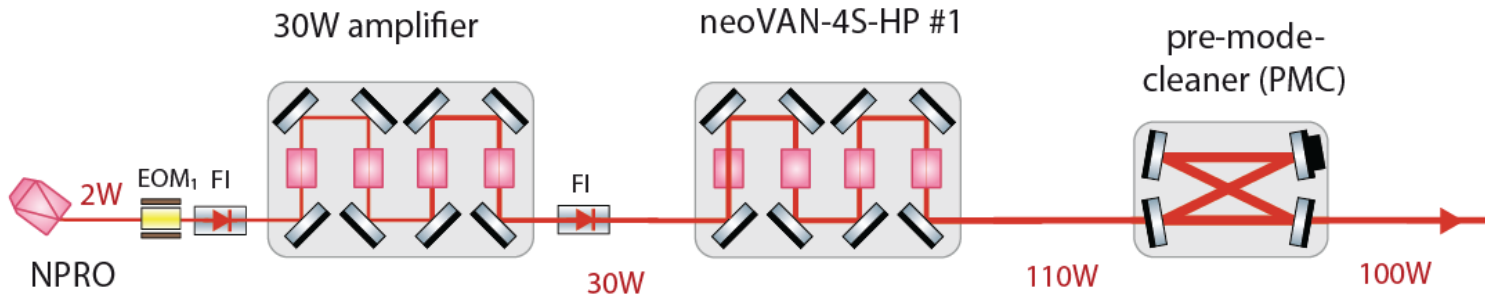

- Replace neoVAN-4S by neoVAN-4S-HP
- Design neoVAN-4S-HP #2 path in HPO area and install once required

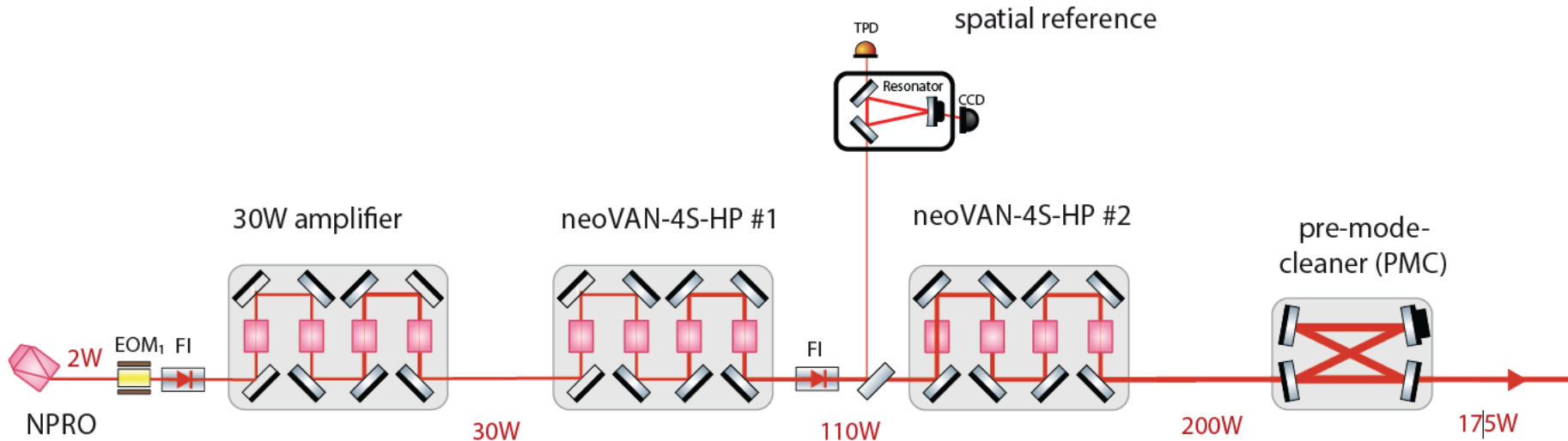

O4 Laser System: Option 2

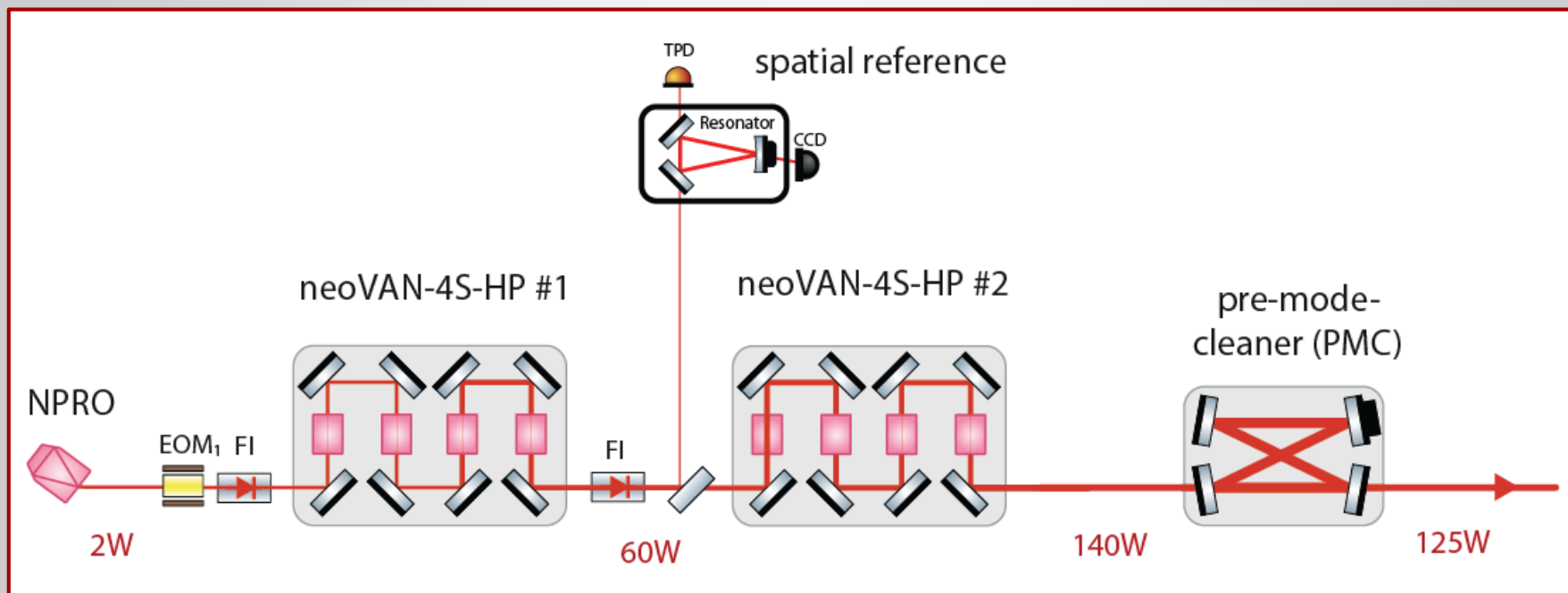

- Two sequential neoVAN-4S-HP amplifier seeded by NPRO

