

$$LM317 VOUT = 1.25 \times (1 + R_{adj}/R_o) + (46\mu A \times R_{adj})$$

12V Voltage Regulator

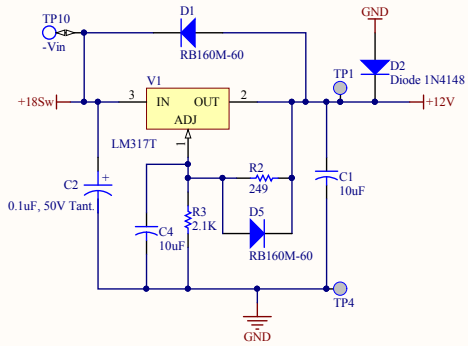

$$LM337 VOUT = -[1.25 \times (1 + R_{adj}/R_o) + (65\mu A \times R_{adj})]$$

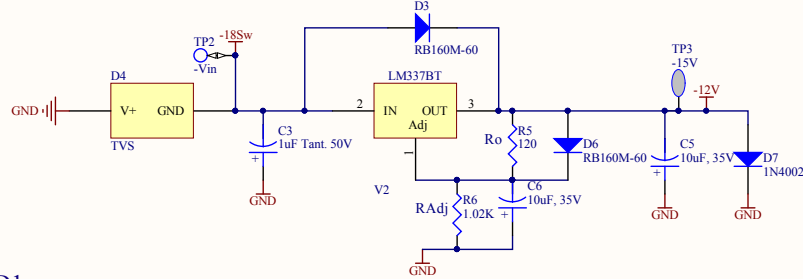

Power Switch

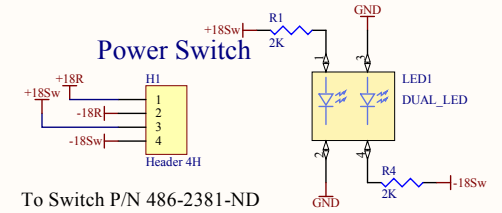

To Switch P/N 486-2381-ND

Power to PD1

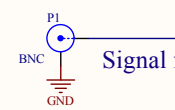
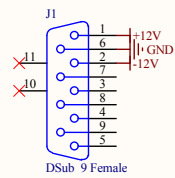

Signal from PD1

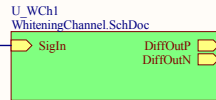

To AA Chassis

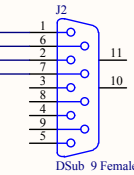

Power to PD2

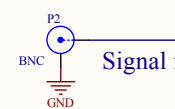
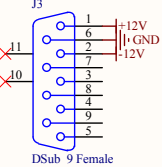

Signal from PD2

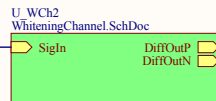

DC Power Input

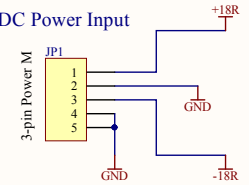

Title Polarization PD Whitening Field Board			
Size: B	DCC Number: D1500441	Ligo Project California Institute of Technology Massachusetts Institute of Technology	
Drawn by: Ben Abbott	Date: 12/4/2015	Revision: v1	
File: C:\restored\Ben\AOS\TCS Stuff\TCSWhitesatellite.SchDoc			

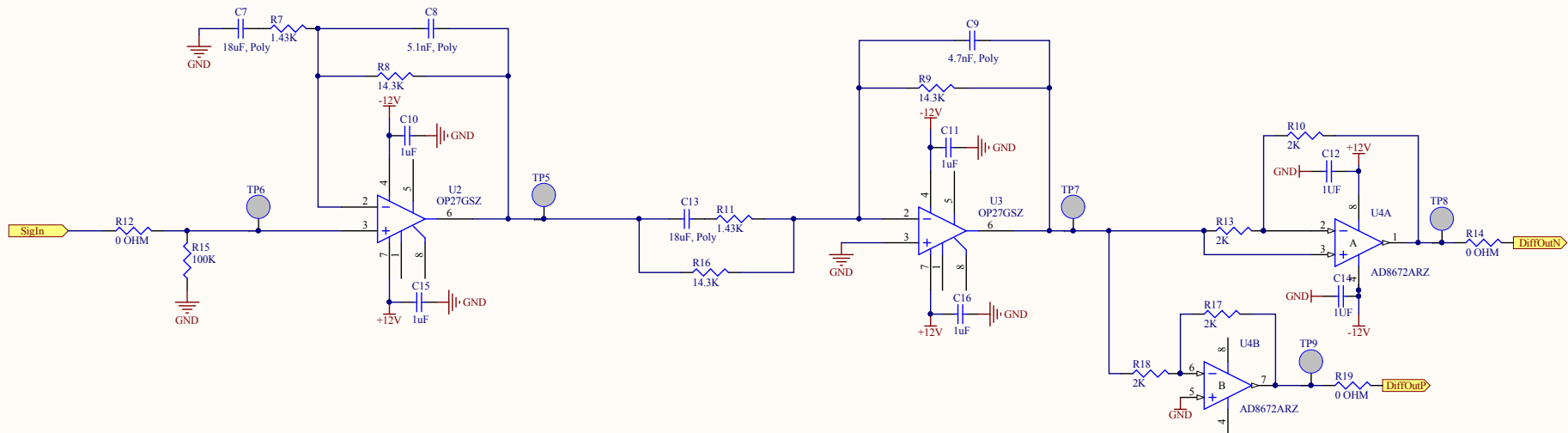
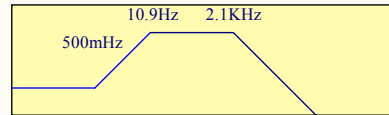
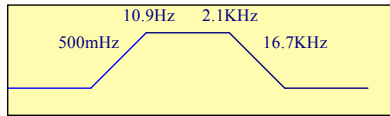

Title Polarization PD Whitening Field Board			
Size: B	DCC Number: D1500441	Ligo Project California Institute of Technology Massachusetts Institute of Technology	
Drawn by: Ben Abbott	Date: 12/4/2015	Revision: v1	
File: C:\restored\Ben\AOS\TCS Stuff\TCS PD Whitening Field Board\14441.PM.Sheet2.dwg			

POLARIZATION PD
WHITENING FIELD BOARD
D1500441-v1

S/N

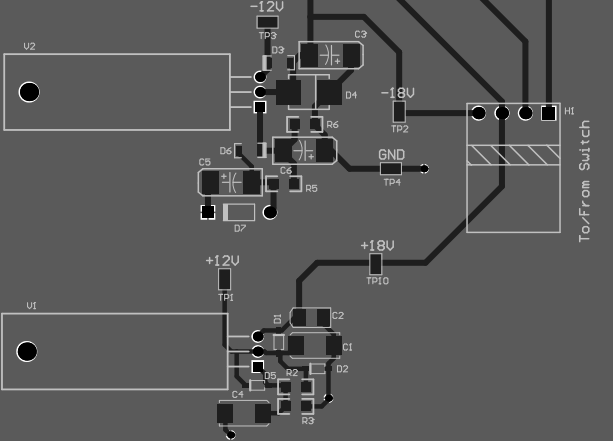

S-Polarization Channel

P-Polarization Channel

