

Suspensions

A modulated NIR calibration system

N.A. Lockerbie and K.V. Tokmakov

University of Strathclyde, Glasgow, Scotland, UK

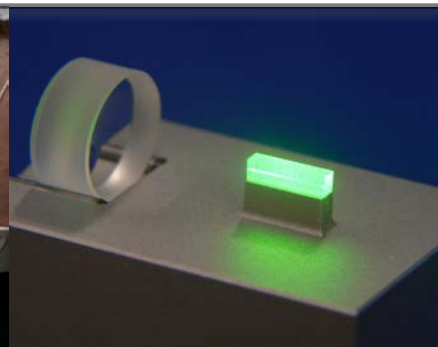
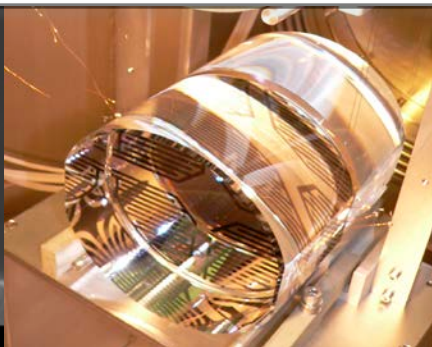
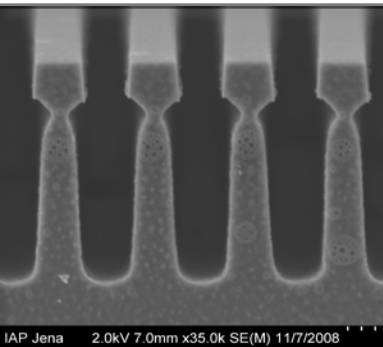



Measurement of AC / DC gain ratio

- Violin-Mode (VM) transimpedance amplifier has a single Photodiode (PD) input.
- Can measure its *DC* response to a quasi-static shadow displacement, in volts per metre, by scanning a silica suspension test fibre's shadow across the PD.
- Need to know the ratio of the PD + amplifier's *AC* to *DC* gain, at a given frequency (such as 500 Hz, the fundamental VM resonance of a silica fibre).
- Then will know the VM calibration of the PD + amplifier in terms of output volts (rms) per metre (rms) of VM oscillation at that frequency.



Passband of prototype VM Amplifier

The ratio of AC voltage gain to the DC ($s = 0$) gain of the prototype VM transimpedance amplifier is: -

$$\frac{V_{AC}}{V_{DC}} = \frac{A (R_F / R_i) s^2 C R C_2 R_2}{(s^2 C R C_F R_F + s C R + R_F / R_i)(s C_2 R_2 + 1)(s C_3 R_3 + 1)}$$

$A = 100$, $R_F = 1.2 \text{ M}\Omega$, $R_i = 120 \text{ k}\Omega$, $R = 100 \text{ k}\Omega$, $C = 100 \text{ nF}$,
 $R_2 = 10 \text{ k}\Omega$, $C_2 = 100 \text{ nF}$, $R_3 = 3 \text{ k}\Omega$, $C_3 = 4.7 \text{ nF}$.

- **So expect Gain Ratio mid-band = 1000** (approximately—expect it to be slightly reduced from this value through its narrowly circumscribed passband).

Control of NIR calibration source

- CW and modulated NIR output beam components forced to be proportional to AC modulation and DC Control input voltages, respectively.

Ref. This circuit was derived from that given in an article by Lukasz Sliwczynska and Marcin Lipinski, Institute of Electronics, Krakow, Poland
EDN, 1 September, 1998.

DC control level
+ (small) AC
modulation at
frequency of
interest.

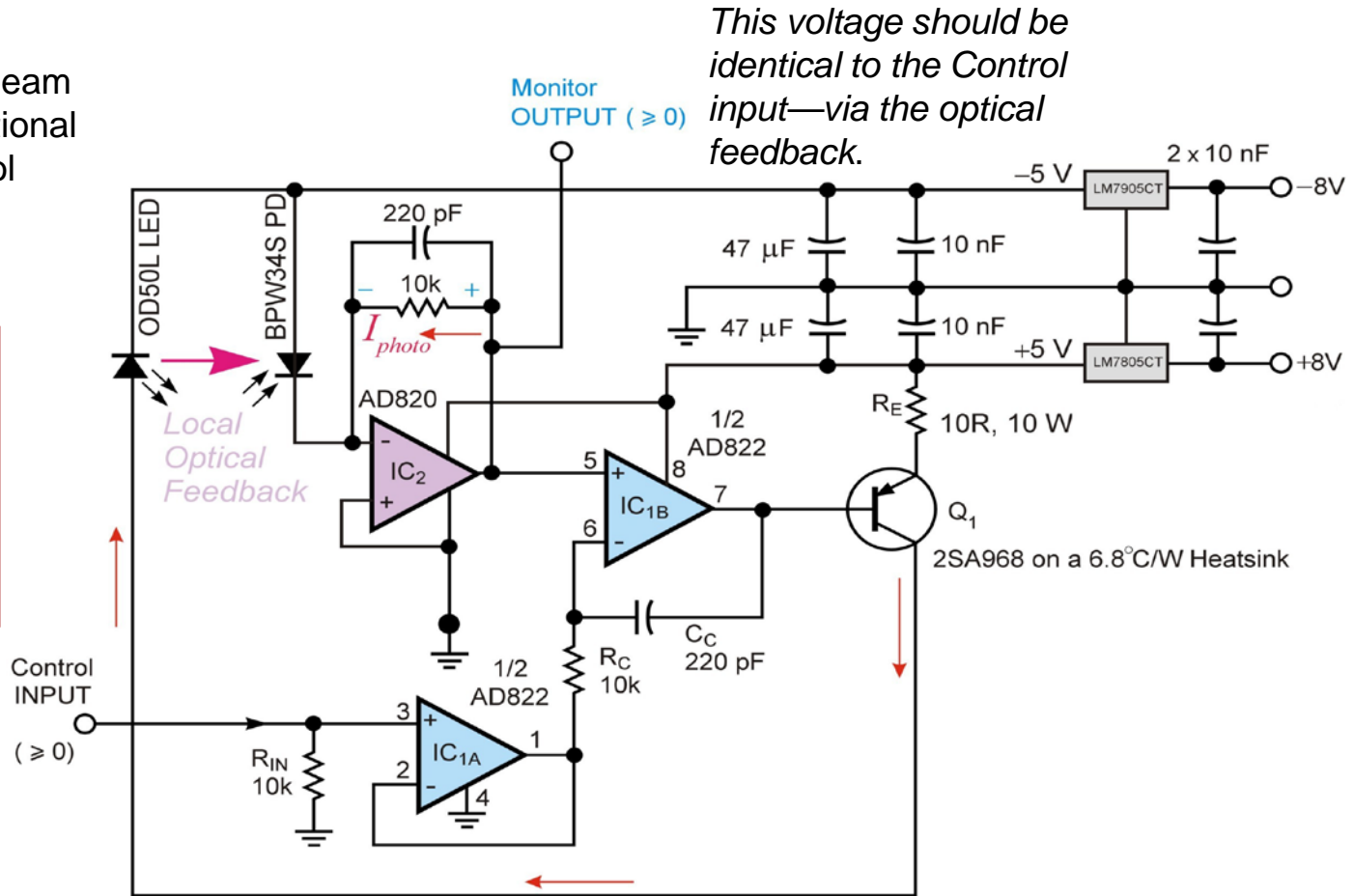

AC Calibration of VM sensor

AC / DC gain ratio =

VM Amp: $\frac{\text{AC output}}{|\text{DC output}|}$.

Monitor: $(\text{AC input} / \text{DC input})$

In this example, AC / DC gain ratio =
 $(27.33/1.023)/(0.058/2.151)$
 = 990.8, at 1 kHz.

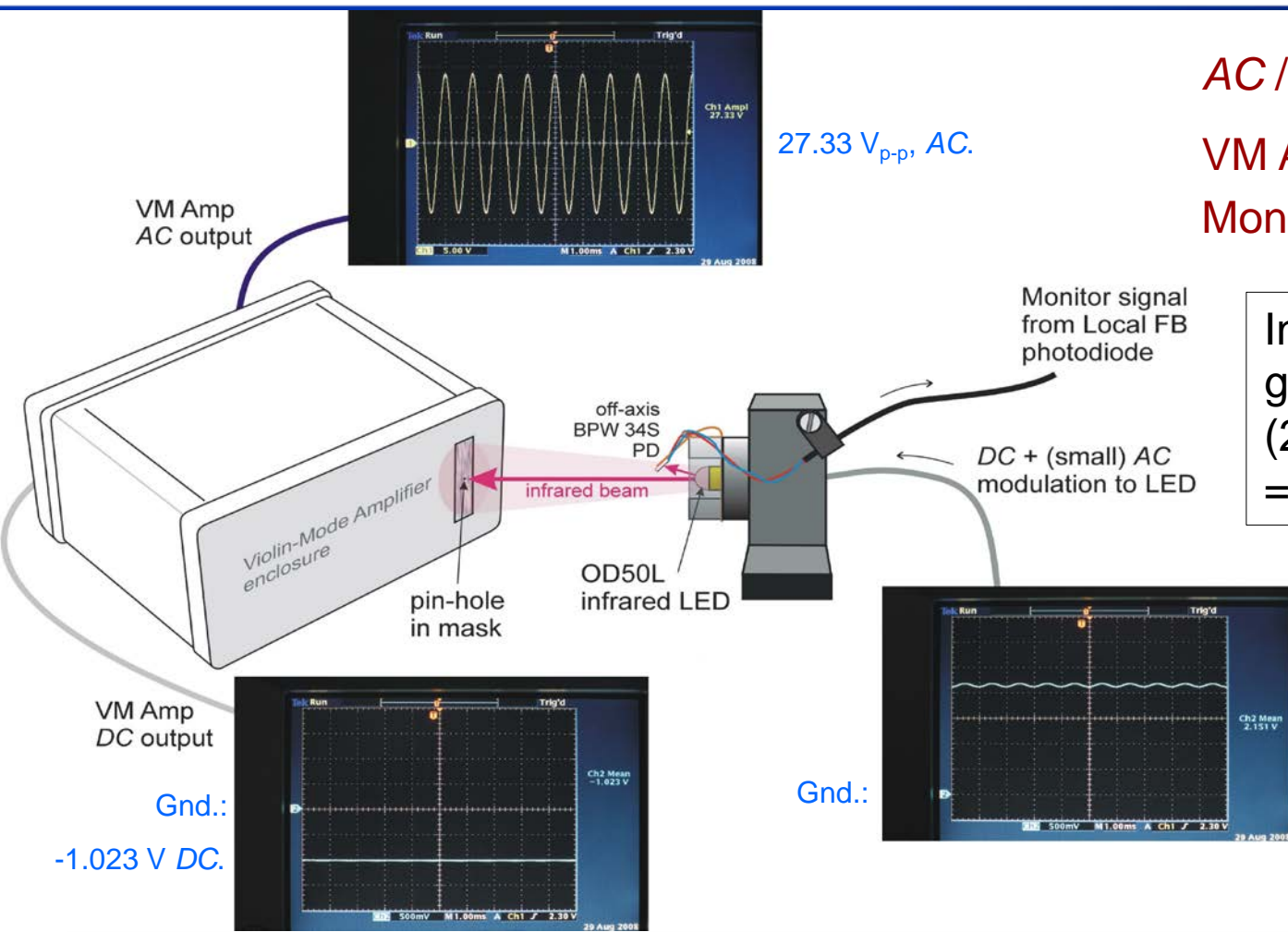



Calibration results for prototype Violin-Mode transimpedance Amplifier

- VM sensors were calibrated *absolutely* in terms of **AC** V / m displacement.
- e.g.: **AC** shadow displacement 'slope sensitivity' at 1 kHz $\cong 1000 \times$ **DC** value.

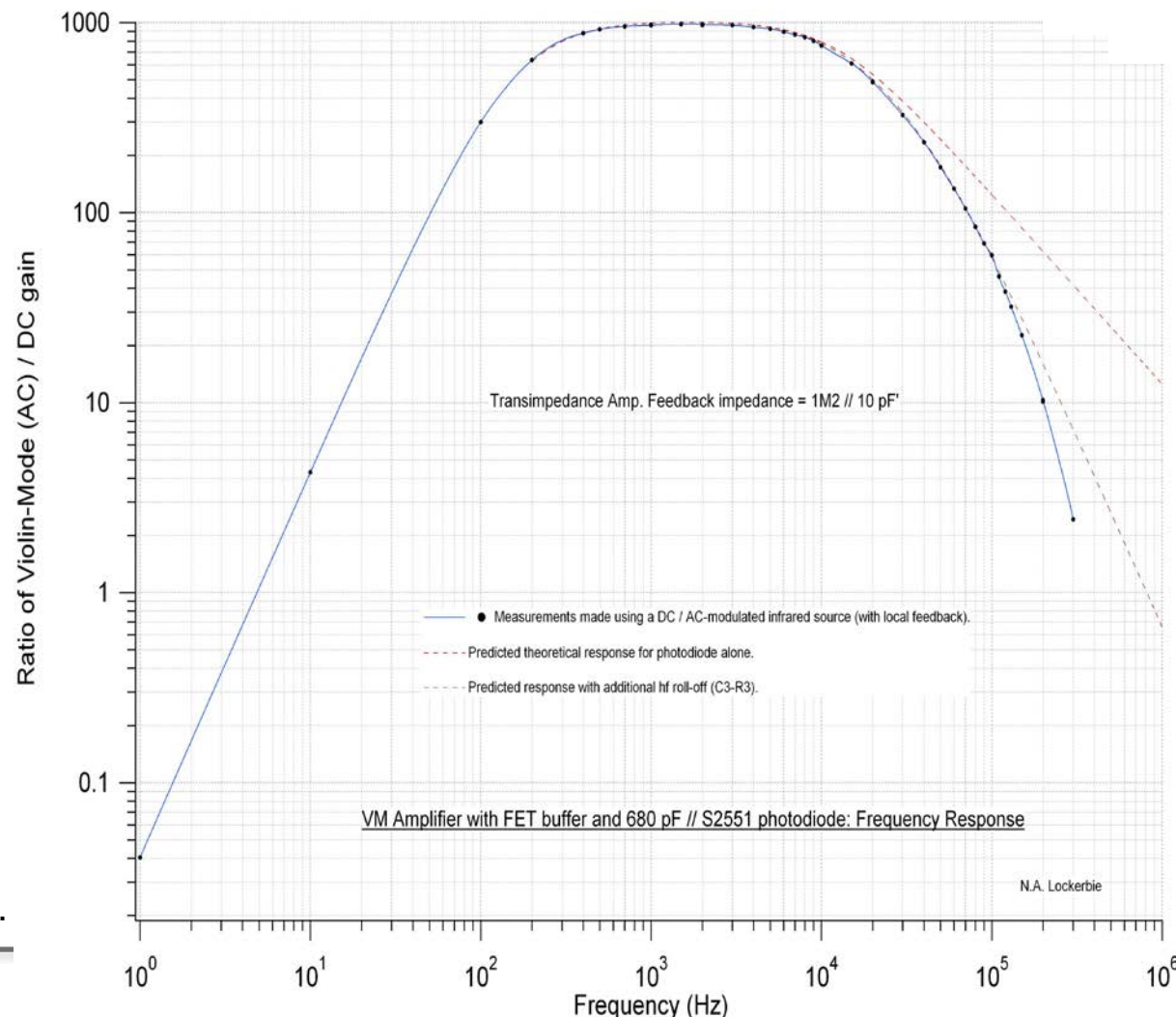

// 680pF simulated the cable capacitance.

'Combined image' dual PD detector

Image of dual-PD detectors (2 × Hamamatsu S2551: each measuring 1.2 mm × 29.1 mm)

Housing for two dual PD detectors.

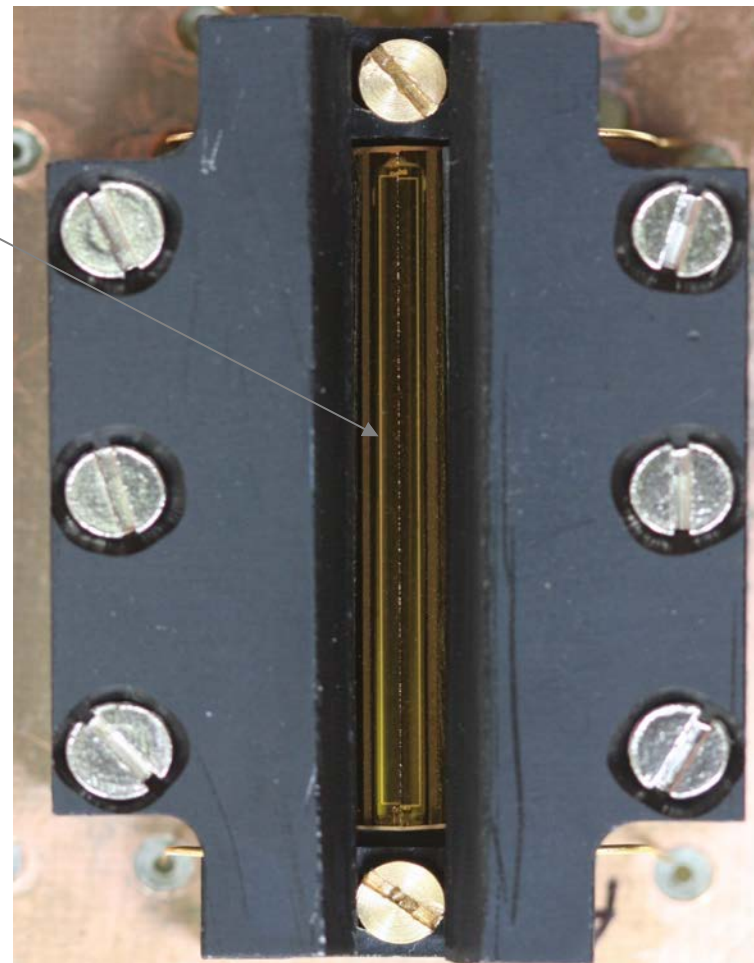
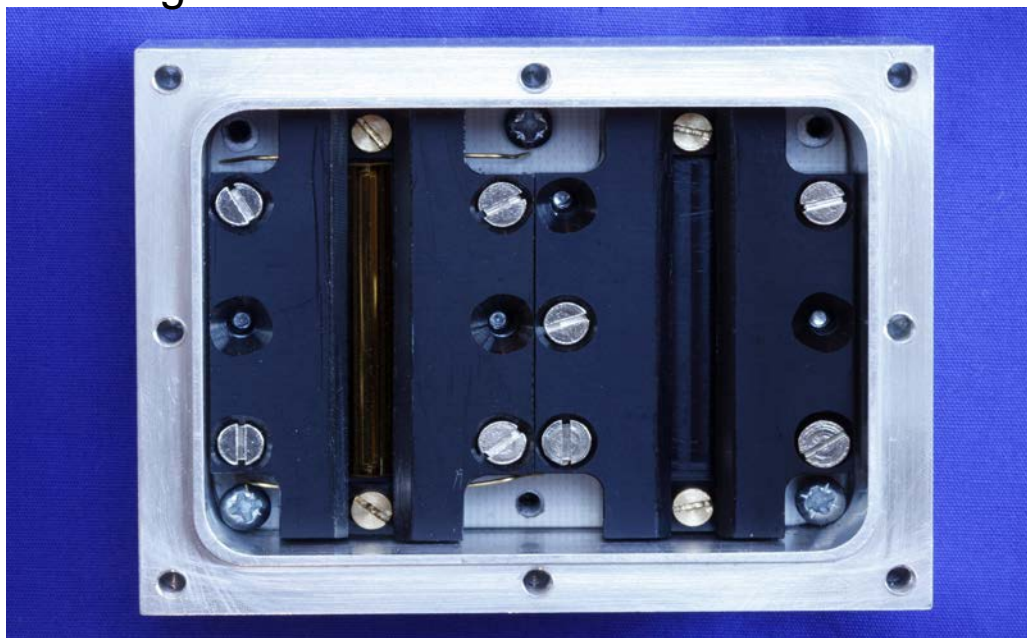



*Detector housing for 2 × dual-PD
shadow detectors, one per silica fibre*

