

### To Interface Board

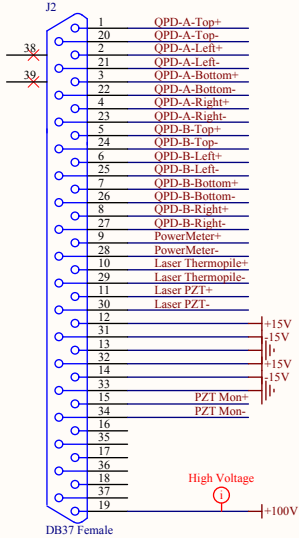

### To ISS Board

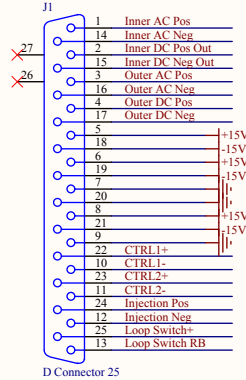

### +100V Input for Piezo

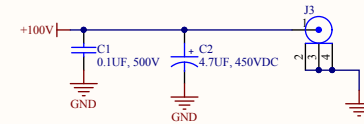

### From Power Board

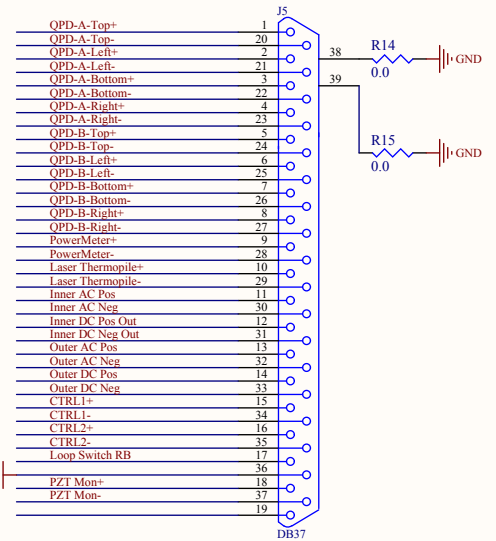
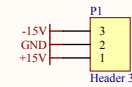

### To AA Chassis

### From AI Chassis

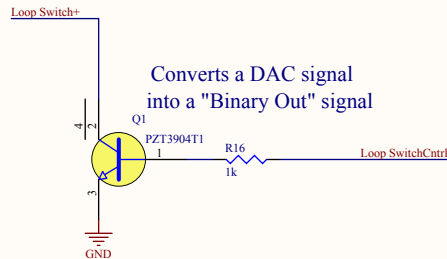
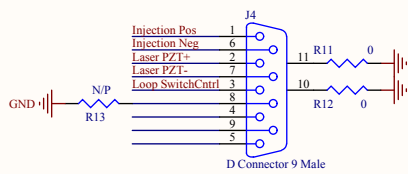

Title <b>aLIGO TCS ISS Signal Back Board</b>			
Size: <b>B</b>	DCC Number: D1300652	Ligo Project California Institute of Technology Massachusetts Institute of Technology	
Drawn by: <b>Ben Abbott</b>	Date: 8/13/2013	Revision: v1	
File: C:\restored\Ben\AOS\TCS\Snuff\TCS ISS Chassis\ISS Signal Back Board.dwg			

