



## Low-extractable piping for ultra-pure water systems

Spears® low-extractable piping systems provide a cost-effective alternative to other piping materials typically used for ultra-pure water applications in the semiconductor, electronics, biotechnology and other industries. Lower material costs combined with fast, reliable installation greatly reduce installation costs – resulting in significant savings without jeopardizing water quality.

In addition to significant cost savings, these piping systems offer several other advantages for ultra-pure water applications. These include: non-contaminating material with extremely low-extractable contaminants (particularly Total Oxidizable Carbon and trace metals), ultra-smooth interior walls, strong Schedule 80 dimensions, specialty one-step solvent-cement joining system that cures fast, and unique translucency for visual inspection of joint integrity.

### Spears® low-extractable Piping Systems offer unique advantages for many ultra-pure water applications

- Complete line of pipe, fittings and valves  
IPS Sizes 1/2" – 6" diameters
- Strong Schedule 80 dimensions for pressure service
- Advanced low-extractable material significantly reduces leachable contamination compared to conventional PVC and other piping materials.
- Exceptionally smooth interior walls reduce particle contaminants
- Fast, reliable installation with simple, inexpensive joining methods
- Proprietary one-step fast setting joining method reduces TOC contamination and rinses up quickly
- Good chemical/corrosion resistance, high-impact strength, low thermal conductivity
- Bagged, sealed and boxed on-line for use in high-purity environments
- High Quality
- Low Maintenance
- Cost Effective



## High Purity- Low Extractable PVC System Technical Information

### Technical Information & Dimensions

#### Materials

Spears® low-extractable piping is produced from an innovative PVC compound that has been specifically formulated to reduce leachable contamination when exposed to ultra-pure water environments. Minor ingredients necessary for processing have been scrupulously selected to address their potential for contamination, and are then carefully blended in precise ratios. This results in a much cleaner material than conventional PVC compounds, and compares favorably to alternate materials typically used for UPW piping applications. This has been validated with extensive static and dynamic leach studies during exposure to 18.2 megohm ultra-pure water conducted by a reputable third party. Refer to testing data on the following pages for comparative evaluation of leachable contaminants obtained from common UPW piping materials.

Spears® low-extractable material meets the toxicological requirements of NSF International Standard 61 as being safe for use in potable water applications, and also complies with the provisions of Title 21 of the United States FDA Code of Federal Regulations as being safe for use in food contact applications.

#### Processing

Processing conditions for converting this material into pipe form are as critical as the selection of the material itself to ensure that the physical properties of the finished product are optimized. Correct processing techniques ensure proper dispersion and fusion of the compound, resulting in a homogenous melt with uniform properties. Great care is also taken during this process using proprietary techniques to address surface finish characteristics. Optimizing processing conditions and providing smooth internal surfaces greatly reduce the potential for extractable and particle contaminant.

Spears® low-extractable pipe is cut square, purged to remove shavings, sealed in polybags and boxed on-line at time of manufacture to minimize contamination. Contact Spears® for availability of additional cleaning options.

#### Joining

The Spears® low-extractable system utilizes a one-step solvent-cementing system specifically formulated for use with this product. Unlike conventional PVC solvent cements, this system contains fewer contaminants and cures quickly, reducing the potential for TOC contamination. Joining is accomplished quickly and efficiently utilizing inexpensive tools, thereby greatly reducing labor and installation costs.

#### Physical Properties

Although the extractable contaminants of this Spears® piping are much lower than those of conventional PVC piping, the physical properties are very similar. As a result, these products exhibit the well-known physical characteristics and other benefits of conventional PVC piping, such as good chemical and corrosion resistance, low thermal conductivity, high strength-to-weight ratio, good impact resistance, and ease of installation.

#### Physical Properties

Property	Value	Test Method
Cell Classification	12343	ASTM D 1784
Specific Gravity	1.327 g/cu. Cm @ 73°F	ASTM D 792
Tensile Strength @ yield	6720 psi	ASTM D 638
Tensile Modulus of Elasticity	384,200 psi	ASTM D 638
Flexural Strength @ yield	11,440 psi	ASTM D 790
Flexural Modulus of Elasticity	378,000 psi	ASTM D 790
Izod Impact (avg of 2 complete breaks) (avg of 3 partial & 2 complete breaks)	1.3 ft-lbs / inch 10.9 ft-lbs / inch	ASTM D 256
Coefficient of Linear Thermal Expansion	$3.89 \times 10^{-5}$ in / in °F	ASTM D 696
Compressive Strength	8732	ASTM D 695
Heat Distortion Temperature	152°F	ASTM D 648
Hardness, Shore D	82.2 ± 3	ASTM D 2240
Maximum Temp Use	140°F	

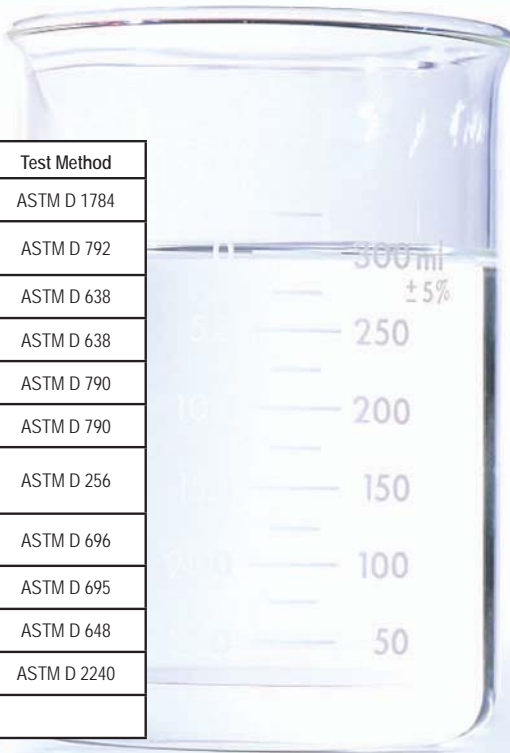



## Testing

Spears® low-extractable piping has been subjected to extensive low-level deflection testing during exposure to UPW by a reputable independent laboratory. Tests under both static and on-line dynamic (flowing) conditions analyze leachable micro contamination (TOC, anions, cations and trace metals) as well as resistivity and particles.



## Static Leach Analysis

Detailed extractable analysis is conducted on piping samples after seven-day static leach utilizing 18.2 megohm ultra-pure water at ambient temperature. Static leach of large pipe samples (120-square-inch wet surface area) is representative of a piping system "off-line" for an extended period of time. Under these conditions the effects of UPW can be extremely aggressive, severely affecting the amount of leachable contaminants present within the piping material.

Element	Pipe Material						
	DL (Detection Limit) ppb	Spears*	High Purity PVDF	High Purity PP	Brand X Clean PVC	Conv. PVC	CPVC
TOC	5	59	90	94	1176	-	50
Fluoride	2	-	77	-	-	-	-
Chloride	0.25	2.33	1.0	0.66	2.45	0.84	49.54
Aluminum	0.05	0.30	2.3	0.68	0.54	3.10	1.16
Barium	0.01	0.04	0.24	0.09	0.01	0.22	0.05
Calcium	3	7	-	12	206	2787	15
Magnesium	0.02	0.81	0.66	1.0	2.15	11.15	2.17
Sodium	0.06	0.83	0.51	0.18	0.49	1.23	23.22
Tin	0.02	0.93	-	-	0.15	0.51	1.19
Zinc	0.06	0.49	0.47	0.96	-	0.51	1.19

\* = Below Detection Limit

- All samples pre-rinsed identically with UPW prior to test.
- Independent Laboratory Extractable Analysis (Balazs Analytical Laboratory)
- Seven-Day Static Leach @ ambient temperature
- 450ml 18.2 megohm ultra-pure water
- 120-square-inch wet surface contact area
- Based on 1" diameter pipe without solvent-cemented joint
- Concentration units expressed as ug/L of Leachate (ppb)

## Dynamic Leach Analysis

Spears® low-extractable piping was subjected to on-line dynamic flow analysis with 18.2 megohm UPW to evaluate particles, TOC, resistivity, anions, cations, and trace metals. This testing utilized solvent-cemented flange assemblies (spool piece) to see the effect that the cement had on TOC, resistivity and particle generation in a freshly assembled pipe section. Grab samples were also pulled periodically (at start-up, five minutes, 50 minutes and five hours) to analyze anions, cations and trace metals under flowing conditions. Flanges were assembled utilizing specially formulated one-step cement and allowed to cure 24 hours prior to testing. Dynamic testing revealed that piping assemblies did not contribute significantly to particle generation or leachable contamination under flowing conditions throughout the test duration.

### Dynamic Test Description

Ambient temperature dynamic leach utilizing 18.2 megohm UPW flowing at 9.35 GPM (turbulent flow). 1" diameter pipe 30" long, solvent-cemented flanges each end (approximately 82-square-inch wet surface contact area). Approximately 1-1/2 grams of specially formulated one-step cement used in assembly of components. Solvent-cemented assembly was allowed to cure 24 hours prior to start-up. Dynamic test was conducted for a period of five hours.

### Leachable Contamination

**Anions/Cations** – IC grab sample analysis revealed low levels of sulfate (0.15 ppb) five minutes into the test, and low levels of ammonium at 50 minutes (0.05 ppb) and five hours (0.07ppb) into the test. All other IC contaminants were below the limit of detection.

**Trace Metals** – Of the 68 trace metal contaminants evaluated, all were below the limit of detection with the exception of aluminum, detected at 0.012 ppb at the five-minute interval. This element remained below the limit of detection throughout the remainder of the leach.

### Resistivity

Resistivity measured 17.95 megohms at the start of the leach and rose quickly to 18.12 megohms during the first 6 minutes. Resistivity readings continued to rise until reaching the background level of 18.2 megohms after five hours of leaching.

Balazs  
ANALYTICAL LABORATORY

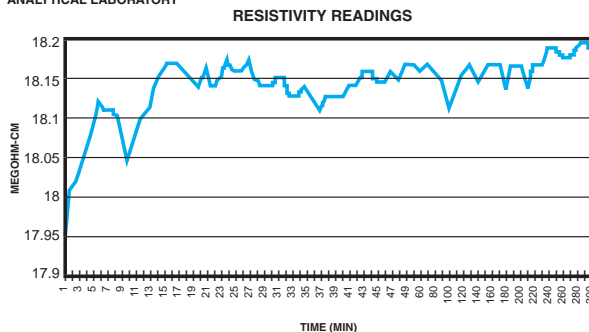

### Total Oxidizable Carbon (TOC)

Dynamic testing revealed that after four hours of leaching, TOC readings reached and maintained the background levels throughout the test duration. This data confirmed the fast cure time of specially formulated one-step cement. Conventional solvent cements and primers used for joining typically effect TOC contamination as a result of the leach.

Balazs  
ANALYTICAL LABORATORY

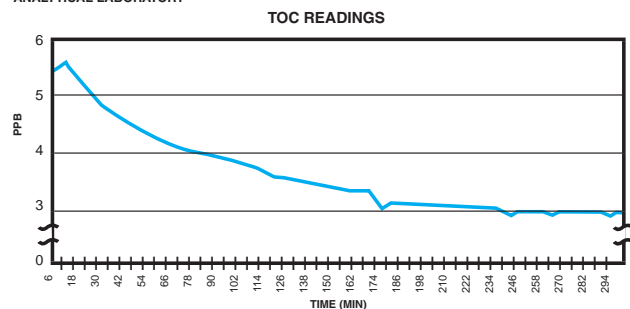



# High Purity- Low Extractable PVC System Technical Information

## Technical Information & Dimensions



### Particles

Dynamic testing revealed that average particle counts decreased rapidly during the first six minutes of the leach. After 12 minutes of leaching the average smallest particles measured (0.05 size range) were representative of the background levels.

Balazs  
ANALYTICAL LABORATORY

0.05u PARTICLE READING

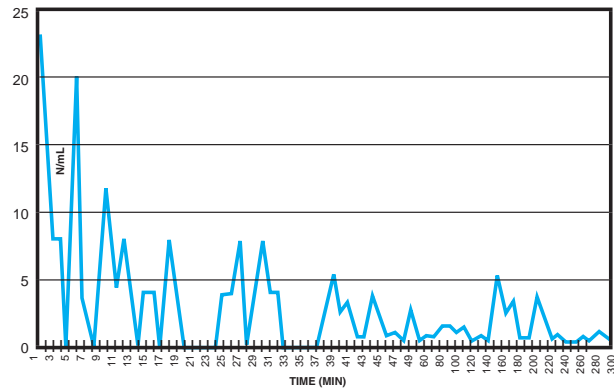

### Surface Analysis

<b>Digital Instruments Nanoscope</b>	
Scan Size	20.00µm
Scan Rate	1.001HZ
Number of Samples	512
Image Data	Height
Data Scale	500.0µm

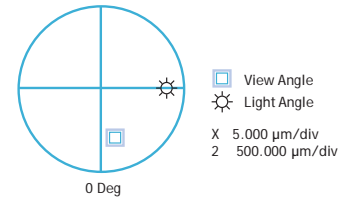
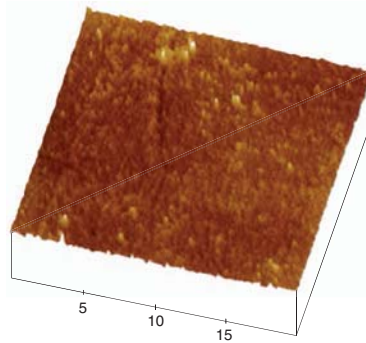

Spears® low-extractable piping has a non-porous, exceptionally smooth interior surface that greatly reduces the potential for extractable and particle contamination while impeding bacterial growth. The components (pipe and fittings) exhibit an average Roughness Analysis value of:  $Ra \leq 0.25 \mu\text{m}$  ( $\leq 10 \mu\text{inch}$ )

Conventional PVC 300x

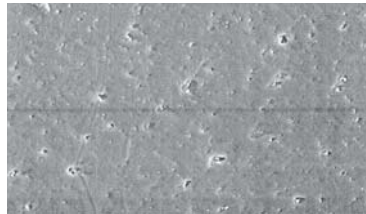

Spears® Low-extractable 300x



### Internal Roughness Comparison

Spears® low-extractable piping has been evaluated side-by-side with other common piping materials at various magnifications for surface roughness comparison.

Spears® Low-extractable 5000x

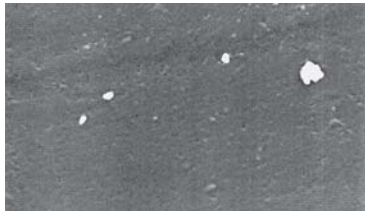

Conventional PVC 5000x

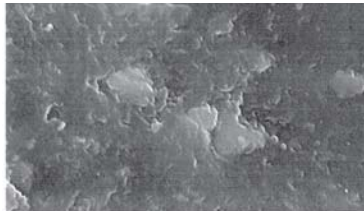

CPVC 5000x

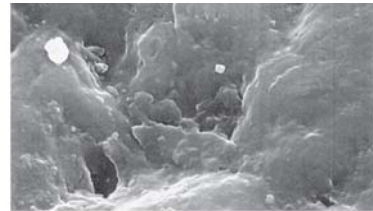

Polypropylene 5000x

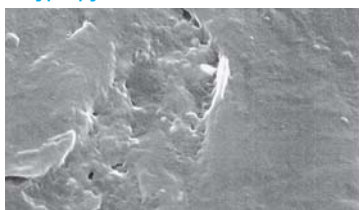

Brand X Clean PVC 5000x

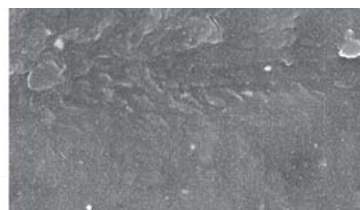

PVDF 5000x

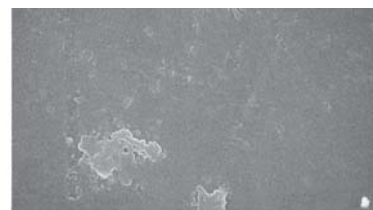



## System Components

Spears® fitting and valve components are manufactured from the same low-extractable material. This provides entire system consistency and compatibility, while ensuring that extractable contamination is kept to a minimum. Leading-edge stress analysis technology is applied in the design of fitting and valve components to optimize strength and performance in critical applications.



## Fittings

High-quality Spears® low-extractable components are designed to yield optimum performance for each fitting. Material reinforcement is uniformly placed in stress-concentration areas for substantially improved pressure-handling capability. Specialty transition fittings incorporate a stainless steel retaining ring that provides a strong, leak-tight seal for plastic-to-metal transitions while reducing problems associated with overtightening. The reinforced design reduces radial stress encountered with typical threaded connections, thereby eliminating the need for system pressure de-rating traditionally associated with non-reinforced plastic threaded joints.

### STANDARD SCHEDULE 80 SOCKET DIMENSIONS ASTM D 2467

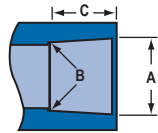

Size (in.)	Entrance A	Bottom B	Minimum Socket Length C	Tolerance (In.)
1/2	.848	.836	.875	± .004
3/4	1.058	1.046	1.000	± .004
1	1.325	1.310	1.125	± .005
1-1/4	1.670	1.655	1.250	± .005
1-1/2	1.912	1.894	1.375	± .006
2	2.387	2.369	1.500	± .006
3	3.516	3.492	1.875	± .008
4	4.518	4.491	2.250	± .009
6	6.647	6.614	3.000	± .011

### Tee Socket x Socket x Socket

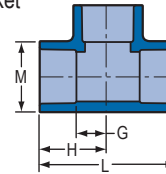

Part #	Size (in.)	G	H	L	M	Weight (lbs.)
801-005BL	1/2	9/16	1-15/32	2-15/16	1-3/16	.10
801-007BL	3/4	11/16	1-11/16	3-3/8	1-13/32	.17
801-010BL	1	27/32	2	4	1-11/16	.28
801-012BL	1-1/4	7/8	2-1/8	4-1/4	2-3/32	.39
801-015BL	1-1/2	1-5/32	2-9/16	5-1/8	2-5/16	.55
801-020BL	2	1-7/16	2-15/16	5-7/8	2-7/8	.90
801-030BL	3	2-1/16	3-31/32	7-15/16	4-7/32	2.38
801-040BL	4	2-5/8	4-7/8	9-3/4	5-1/4	3.43
801-060BL	6	3-13/16	6-13/16	13-5/8	7-5/8	10.79

### Reducing Tee

Socket x Socket x Socket

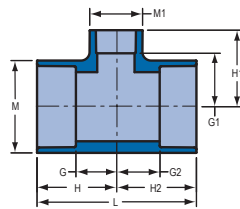

Part #	Size (in.)	G	G1	G2	H	H1	H2	L	M	M1	Weight (lbs.)
801-131BL	1x1x3/4	23/32	27/32	23/32	1-27/32	1-27/32	1-27/32	3-11/16	1-11/16	1-3/8	.23
801-211BL	1-1/2x1-1/2 1	7/8	1-3/16	7/8	2-1/4	2-5/16	2-1/4	4-1/2	2-3/8	1-11/16	.46
801-249BL	2x2x1	7/8	1-7/16	7/8	2-3/8	2-9/16	2-3/8	4-3/4	2-7/8	1-3/4	.58
801-251BL	2x2x1-1/2	1-3/16	1-7/16	1-3/16	2-11/16	2-13/16	2-11/16	5-3/8	2-7/8	2-3/8	.80
801-338BL	3x3x2	1-1/2	1-15/32	1-1/2	3-5/16	3-11/32	3-5/16	6-5/8	4-3/16	2-7/8	1.56
801-422BL	4x4x3	2-1/16	2-21/32	2-1/16	4-11/32	4-15/32	4-11/32	8-11/16	5-7/32	4-3/16	3.09
801-530BL	6x6x3	2-11/16	4-9/16	2-11/16	5-9/16	6-3/8	5-9/16	11-1/8	7-1/2	5-3/16	6.34
801-532BL	6x6x4	2-11/16	3-3/4	2-11/16	5-9/16	5-15/16	5-9/16	11-1/8	7-1/2	5-1/4	7.43





## High Purity- Low Extractable PVC System Technical Information

### Technical Information & Dimensions

#### 90° Elbow Socket x Socket

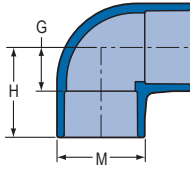

Part #	Size (in.)	G	H	M	Weight (lbs.)
806-005BL	1/2	9/16	1-15/32	1-3/16	.08
806-007BL	3/4	11/16	1-11/16	1-7/16	.12
806-010BL	1	13/16	1-31/32	1-23/32	.19
806-012BL	1-1/4	1-1/32	2-5/16	1-31/32	.33
806-015BL	1-1/2	1-3/32	2-15/32	2-11/32	.54
806-020BL	2	1-7/16	2-15/16	2-7/8	.61
806-030BL	3	2-1/16	3-31/32	4-5/32	1.57
806-040BL	4	2-19/32	4-27/32	5-1/4	2.80
806-060BL	6	3-23/32	6-3/4	7-19/32	8.59

#### Sweep Elbow Socket x Socket

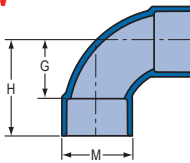

Part #	Size (in.)	G	H	M	Weight (lbs.)
806-005SBL	1/2	27/32	1-23/32	1-3/16	.07
806-007SBL	3/4	1-1/32	2-1/32	1-13/32	.11
806-010SBL	1	1-5/16	2-7/16	1-23/32	.19
806-012SBL	1-1/4	1-9/16	2-13/16	2-3/32	.28
806-015SBL	1-1/2	1-3/4	3-1/8	2-11/32	.37
806-020SBL	2	2-5/16	3-13/16	2-7/8	.61

#### 45° Elbow Socket x Socket

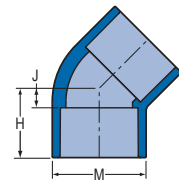

Part #	Size (in.)	H	J	M	Weight (lbs.)
817-005BL	1/2	1-1/8	1/4	1-3/16	.06
817-007BL	3/4	1-11/32	11/32	1-13/32	.09
817-010BL	1	1-7/16	11/32	1-23/32	.15
817-012BL	1-1/4	1-11/16	13/32	2-3/32	.21
817-015BL	1-1/2	1-27/32	7/16	2-3/8	.30
817-020BL	2	2-5/32	21/32	2-7/8	.48
817-030BL	3	2-27/32	31/32	4-1/8	1.13
817-040BL	4	3-3/8	1-3/32	5-1/4	2.24
817-060BL	6	4-7/8	1-7/8	7-9/16	5.37

All Spears® low-extractable fittings are produced in strict dimensional compliance with ASTM D 2467 to Schedule 80 dimensions. Spears® components produced to these dimensions ensure that strong, leak-tight connections with exceptional pressure-bearing capability can be assembled quickly using inexpensive joining tools. Refer to charts below for dimensional and weight data of available fittings.

**NOTE:** The information contained in this publication is based on current data and product design at time of publication and may be subject to change. Additional components and configurations may be added periodically due to our continued commitment to product-line improvements.

#### Coupling Socket x Socket

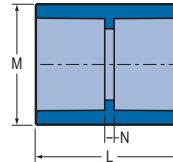

Part #	Size (in.)	L	M	N	Weight (lbs.)
829-005BL	1/2	1-7/8	1-3/16	1/8	.07
829-007BL	3/4	2-1/8	1-13/32	1/8	.10
829-010BL	1	2-3/8	1-23/32	1/8	.12
829-012BL	1-1/4	2-23/32	2-7/32	7/32	.22
829-015BL	1-1/2	2-7/8	2-11/32	3/32	.31
829-020BL	2	3-1/8	2-7/8	1/16	.31
829-030BL	3	4	4-3/16	3/16	.82
829-040BL	4	4-3/4	5-5/16	1/4	1.51
829-060BL	6	6-1/4	7-11/16	1/4	3.45

#### Reducer Coupling Socket x Socket

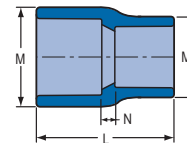

Part #	Size (in.)	L	M	M1	N	Weight (lbs.)
829-101BL	3/4 x 1/2	1-13/32	1-13/32	1-3/16	7/32	.06
829-131BL	1 x 3/4	2-13/32	1-23/32	1-13/32	1/4	.10
829-168BL	1-1/4 x 1	2-23/32	2-3/32	1-23/32	3/8	.17
829-211BL	1-1/2 x 1	2-7/8	2-11/32	1-15/16	3/8	.23
829-212BL	1-1/2 x 1-1/4	2-13/16	2-3/8	2-3/32	5/32	.21
829-249BL	2 x 1	3-1/8	2-7/8	1-23/32	17/32	.28
829-251BL	2 x 1-1/2	3-7/32	2-27/32	2-11/32	7/32	.30
829-338BL	3 x 2	4	4-5/32	2-27/32	11/16	.68
829-420BL	4 x 2	4-5/8	5-9/32	2-7/8	13/16	1.20
829-422BL	4 x 3	4-5/8	5-1/4	4-1/8	1/2	1.25
829-532BL	6 x 4	6-5/8	7-5/8	5-5/16	1-7/16	3.20



## Fittings

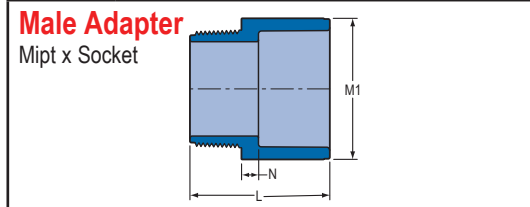

Part #	Size (in.)	L	M	N	Weight (lbs.)
836-005BL	1/2	1-13/16	1-3/16	3/16	.04
836-007BL	3/4	1-29/32	1-13/32	1/4	.06
836-010BL	1	2-1/4	1-3/4	7/32	.10
836-012BL	1-1/4	2-1/2	2-1/8	9/32	.15
836-015BL	1-1/2	2-9/16	2-13/32	1/4	.19
836-020BL	2	2-23/32	2-29/32	9/32	.27
836-030BL	3	3-23/32	4-7/32	3/8	.75
836-040BL	4	4-3/8	5-3/16	1/2	1.13

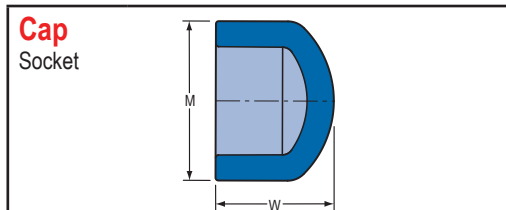

Part #	Size (in.)	M	W	Weight (lbs.)
847-005BL	1/2	1-3/16	1-7/32	.03
847-007BL	3/4	1-3/8	1-13/32	.05
847-010BL	1	1-11/16	1-19/32	.08
847-012BL	1-1/4	2-3/32	1-27/32	.16
847-015BL	1-1/2	2-11/32	2	.16
847-020BL	2	2-27/32	2-9/32	.35
847-030BL	3	4-5/32	3-1/32	.84
847-040BL	4	5-7/32	3-9/16	1.43
847-060BL	6	7-1/2	4-7/8	3.17

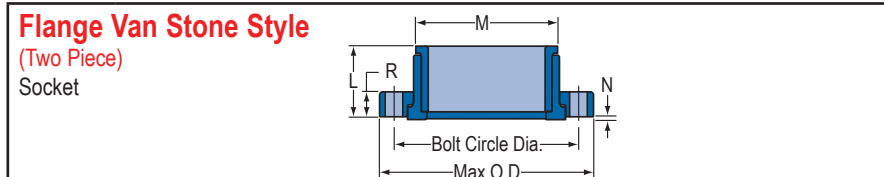

Part #	Size (in.)	L	M	N	R	Bolt Circle Dia.	No. of Bolt Holes	Bolt Size	Max O.D.	Weight (lbs.)
854-005BL	1/2	1-1/32	1-7/32	5/32	17/32	2-3/8	4	1/2	3-1/2	.19
854-007BL	3/4	1-1/8	1-7/16	5/32	9/16	2-3/4	4	1/2	3-7/8	.26
854-010BL	1	1-9/32	1-3/4	5/32	5/8	3-1/8	4	1/2	4-1/4	.36
854-012BL	1-1/4	1-13/32	2-5/32	5/32	11/16	3-1/2	4	1/2	4-5/8	.46
854-015BL	1-1/2	1-17/32	2-7/16	3/16	3/4	3-7/8	4	1/2	5	.56
854-020BL	2	1-11/16	2-15/16	3/16	13/16	4-3/4	4	5/8	6	.85
854-030BL	3	2-1/8	4-1/4	1/4	1-1/16	6	4	5/8	7-1/2	1.66
854-040BL	4	2-1/2	5-1/4	1/4	1-1/8	7-1/2	8	5/8	9	2.68
854-060BL	6	3-3/8	7-9/16	7/16	1-9/32	9-1/2	8	3/4	11	4.54

**NOTE:** Spears® low-extractable flanges maximum working pressure 150 psi non-shock @ 73° F

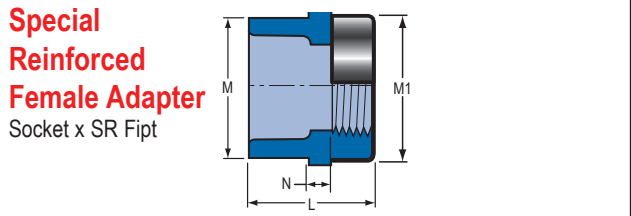

Part #	Size (in.)	L	M	M1	N	Weight (lbs.)
835-005SRBL	1/2	1-3/4	1-5/32	1-3/16	3/16	.07
835-007SRBL	3/4	1-7/8	1-13/32	1-3/8	1/8	.08
835-010SRBL	1	2-5/32	1-23/32	1-23/32	3/32	.12
835-012SRBL	1-1/4	2-5/16	2-1/8	2-1/16	3/16	.19
835-015SRBL	1-1/2	2-7/16	2-13/32	2-7/16	7/32	.26
835-020SRBL	2	2-11/16	3	3-3/32	9/32	.43
835-030SRBL	3	3-1/2	4-1/4	4-9/32	7/32	.89
835-040SRBL	4	3-31/32	5-7/32	5-7/32	1/4	1.29

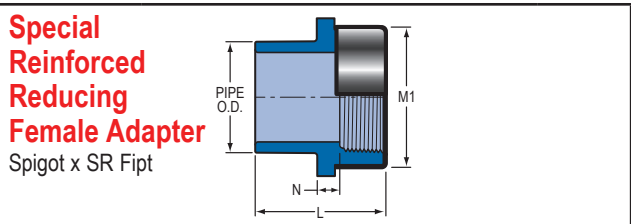

Part #	Size (in.)	L	M1	N	Weight (lbs.)
878-072SRBL	1/2 x 1/4	1-13/32	27/32	3/16	.03
878-098SRBL	3/4 x 1/4	1-27/32	27/32	9/32	.05
878-128SRBL	1 x 1/4	2-3/8	27/32	21/32	.08

## Threaded Connections

Use only quality grade PTFE tape as a thread sealant for Spears® low-extractable applications. **Warning:** some pipe joint compounds or PTFE pastes may contain substances that could cause stress cracking to plastics and increase the potential for system contamination. 1 to 2 full turns beyond finger tight is generally all that is required to make a sound plastic threaded connection. Unnecessary over-tightening will cause damage to both pipe and fitting.

## Flanges

Spears® low-extractable Van Stone-style flanges are also available for transition to alternate materials or where disassembly may be required. This unique two-piece design incorporates a rotating flange ring that greatly simplifies bolt hole alignment during installation.



## High Purity- Low Extractable PVC System Technical Information

### Technical Information & Dimensions

#### Tank Adapter

Socket x Socket

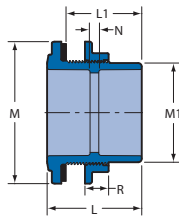

Part #	Size (in.)	Hole Size (in.)	L	L1	M	M1	N	R	Weight (lbs.)
8170E-005BL	1/2	1.31	2-15/16	2-3/16	2	1-3/16	1-1/8	5/8	.20
8170E-007BL	3/4	1.69	2-15/16	2-3/16	2-1/4	1-5/8	15/16	5/8	.24
8170E-010BL	1	1.94	3-5/16	2-9/16	2-5/8	2	1-1/16	5/8	.35
8170E-012BL	1-1/4	2.39	3-7/16	2-5/8	3-1/8	2-5/16	15/16	5/8	.42
8170E-015BL	1-1/2	2.39	3-5/8	2-13/16	3-5/8	2-11/16	13/16	5/8	.93
8170E-020BL	2	3.51	4-1/8	3-1/4	4-7/8	3-1/4	1-1/16	3/4	1.30
8170E-030BL	3	4.49	5-1/2	4-1/2	6	4-9/16	1-11/16	1	2.50
8170E-040BL	4	5.50	5	4	7-1/2	5-1/2	7/16	1-1/4	3.40

EPDM Gasket – 150 psi maximum working pressure @73°F. For FKM Gasket, replace the E with V.

#### Gauge Guards

Spears® low-extractable gauge guards isolate process pressure or vacuum gauges from corrosive or potentially damaging process media by use of a thin PTFE diaphragm (optional FKM or EPDM available). This flexible membrane accurately transmits system pressure to the gauge connection chamber when properly assembled with gauge and liquid filled. A variety of optional gauges are available, factory assembled to the gauge guard and pre-filled. All gauge guards have 1/4" NPT gauge outlet connections. Inlet connections are either 1/4" or 1/2" NPT, featuring Spears® patented Special Reinforced (SR) female plastic thread.

#### Reducer Bushing

Flush Style

Spigot x Socket

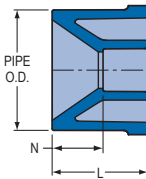

Part #	Size (in.)	L	N	Weight (lbs.)
837-101BL	3/4 x 1/2	1-7/32	11/32	.03
837-130BL	1 x 1/2	1-5/8	13/32	.06
837-131BL	1 x 3/4	1-11/32	5/16	.04
837-166BL	1-1/4 x 1/2	1-1/2	5/8	.12
837-168BL	1-1/4 x 1	1-19/32	15/32	.08
837-210BL	1-1/2 x 3/4	1-3/4	11/16	.19
837-211BL	1-1/2 x 1	1-17/32	13/32	.14
837-212BL	1-1/2 x 1-1/4	1-9/16	5/16	.07
837-249BL	2 x 1	1-29/32	13/16	.26
837-251BL	2 x 1-1/2	1-3/4	11/32	.17
837-338BL	3 x 2	2-27/32	9/16	.62
837-422BL	4 x 3	2-21/32	25/32	.82
837-532BL	6 x 4	4	1-23/32	2.86

#### Gauge Guard PTFE Diaphragm

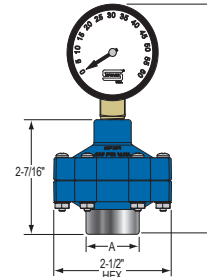

Gauge Configuration	1/4" Inlet	A	B	1/2" Inlet	A	B
No Gauge	G0004-002BL	7/8	—	G0004-005BL	1-3/16	—
0-30 in-Hg	G30V4-002BL	7/8	4-13/16	G30V4-005BL	1-3/16	4-7/8
0-15 psi	G0154-002BL	7/8	4-13/16	G0154-005BL	1-3/16	4-7/8
0-30 psi	G0304-002BL	7/8	4-13/16	G0304-005BL	1-3/16	4-7/8
0-60 psi	G0604-002BL	7/8	4-13/16	G0604-005BL	1-3/16	4-7/8
0-100 psi	G1004-002BL	7/8	4-13/16	G1004-005BL	1-3/16	4-7/8
0-160 psi	G1604-002BL	7/8	4-13/16	G1604-005BL	1-3/16	4-7/8
0-200 psi	G2004-002BL	7/8	4-13/16	G2004-005BL	1-3/16	4-7/8
0-300 psi	G3004-002BL	7/8	4-13/16	G3004-005BL	1-3/16	4-7/8

**NOTE:** Spears® low-extractable Gauge Guards carry a maximum pressure rating of 235 psi, non-shock, @73°F; vacuum gauges suitable for full vacuum service. All gauge guards have 1/4" NPT gauge outlet connections. Gauges are a standard 1/4" NPT brass bottom mount, epoxy enamel steel case, black marking on white face, black dial.

#### Reducer Bushing

Flush Style

Spigot x Fipt

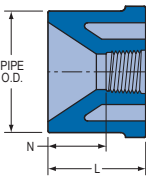

Part #	Size (in.)	L	N	Weight (lbs.)
838-072BL	1/2 x 1/4	1	7/8	.02
838-073BL	1/2 x 3/8	1-3/32	17/32	.02
838-098BL	3/4 x 1/4	1-7/32	5/8	.04
838-101BL	3/4 x 1/2	1-1/4	7/16	.03
838-129BL	1 x 3/8	1-13/32	19/32	.07
838-130BL	1 x 1/2	1-5/32	21/32	.06
838-131BL	1 x 3/4	1-3/8	21/32	.05
838-210BL	1-1/2 x 3/4	1-3/4	31/32	.15

#### Union

(Old Style)

Socket x Socket

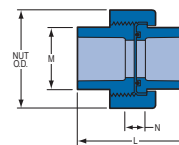

Part # *EPDM O-ring Seal	Size (in.)	L	M	N	Nut O.D.	Weight (lbs.)
897-005BL	1/2	2-3/32	1-9/32	11/32	1-31/32	.12
897-007BL	3/4	2-3/8	1-17/32	11/32	2-1/2	.17
897-010BL	1	2-9/16	1-27/32	3/8	2-7/8	.28
897-012BL	1-1/4	2-7/8	2-7/32	3/8	3-5/16	.36
897-015BL	1-1/2	3-3/32	2-9/16	15/32	3-9/16	.50
897-020BL	2	3-5/8	3-1/32	9/16	4-3/16	.86
8097-030BL	3	4-1/4	4-3/16	1/2	6-5/32	2.16
8097-040BL	4	5-1/8	5-1/4	5/8	7-3/4	3.43

\*For (Socket X Socket) Unions equipped with FKM O-Ring, replace the 897 with an 857 before the dash.





## Valves

Spears® low-extractable valves are available in two styles: True Union Diaphragm configurations sizes 1/2" – 2" and True Union 2000 ball valve configurations sizes 1/2" – 4". Spears® low-extractable diaphragm valves (sizes 1/2" – 2") carry a maximum pressure rating of 150 psi for water, non-shock, @ 73°F. Spears® low-extractable ball valves sizes 1/2" – 4" carry a maximum pressure rating of 235 psi for water, non-shock, @ 73°F.

### Diaphragm Valves

Spears® low-extractable diaphragm valves are engineered to provide accurate throttling control and shut-off, utilizing a positive-stop, non-rising stem. The Weir-type design incorporates a PTFE diaphragm for maintaining purity, and uses EPDM O-ring seals on the union connections. Low-profile True Union design minimizes space while allowing for ease of installation

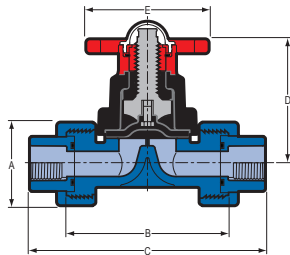

### True Union Diaphragm Valves

Part #	Size (in.)	A	B	C	D	E	Weight (lbs.)
2729T-005BL	1/2	1-15/16	3-7/8	5-3/16	3-11/32	2-7/8	.8
2729T-007BL	3/4	2-1/2	4-1/2	5-15/16	3-3/4	3-1/8	1.3
2729T-010BL	1	2-9/16	4-15/16	6-13/16	4-7/16	3-3/8	2.2
2729T-012BL	1-1/4	3-5/16	5-1/2	8-1/4	5-5/8	3-7/8	2.8
2729T-015BL	1-1/2	3-17/32	6-5/16	8-7/16	5-5/8	4-5/8	3.7
2729T-020BL	2	4-7/32	7-1/2	9-1/2	7	6-5/8	6.7

**NOTE:** Spears® low-extractable True Union Diaphragm valves sizes 1/2" – 2" carry a maximum pressure rating of 150 psi for water, non-shock, @ 73°F.

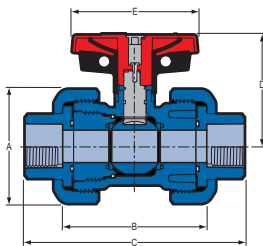

### True Union 2000 Industrial Ball Valves

Part # *EPDM O-rings	Size (in.)	A	B	C	D	E	Weight (lbs.)
1829-005BL	1/2	1-7/8	2-3/8	4-3/16	2-9/16	2-13/16	.36
1829-007BL	3/4	2-1/4	2-3/4	4-3/4	2-7/8	3-3/8	.56
1829-010BL	1	2-1/2	2-7/8	5-1/8	3-1/8	3-7/16	.74
1829-012BL	1-1/4	3-1/16	3-1/4	5-3/4	3-5/8	3-7/8	1.13
1829-015BL	1-1/2	3-1/2	3-1/2	6-1/4	4	4-3/16	1.54
1829-020BL	2	4-1/4	4-3/4	7-3/4	4-1/2	5-1/8	2.72
1822-030BL	3	6-3/16	7	10-11/16	5-7/8	7-5/8	7.46
1822-040BL	4	7-5/8	7-5/16	11-7/8	6-3/4	9-3/16	12.35

**NOTE:** Spears® low-extractable True Union ball valves sizes 1/2" - 4" carry a maximum pressure rating of 235 psi for water, non-shock, @ 73°F.

\*For True Union 2000 ball valves equipped with FKM O-ring seals, replace the 1829 with 1839 in the Part Number.

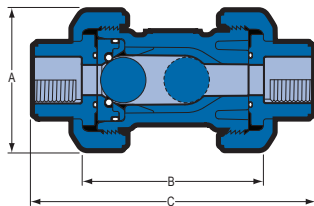

### True Union 2000 Industrial Ball Check Valves

Part # *EPDM O-rings	Size (in.)	Dimension Reference (inches + 1/16)			Approx. Wt. (Lbs.)	Cv <sup>2</sup>	Horizontal Closing	
		A	B	C			PVC	Soc/Thd
4529-005BL	1/2	1-7/8	2-7/16	4-3/16	0.72	6.3	1.6	.30
4529-007BL	3/4	2-1/4	2-3/4	4-3/4	1.19	17	1.6	.46
4529-010BL	1	2-1/2	2-7/8	5-1/8	1.53	25	1.6	.70
4529-012BL	1-1/4	3-1/16	3-1/4	5-3/4	1.85	65	1.6	1.04
4529-015BL	1-1/2	3-1/2	3-1/2	6-1/4	2.97	86	1.6	1.37
4529-020BL	2	4-1/4	4-3/4	7-3/4	4.55	130	1.6	2.47
4522-030BL	3	6-3/16	6-7/8	10-11/16	11.15	275	1.0	6.98
4522-040BL	4	7-1/2	7-1/4	11-13/16	16.58	500	1.0	12.13

1: Valve Lay Length

2: Gallons per minute at 1 psi pressure drop. Values based on independent testing by California State Polytechnic University.

**NOTE:** Spears® low-extractable True Union ball check valves sizes 1/2" - 4" carry a maximum pressure rating of 235 psi for water, non-shock, @ 73°F.

\*For True Union 2000 ball check valves equipped with FKM O-ring seals, replace the 4529 with 4539 in the Part Number.





## High Purity- Low Extractable PVC System Technical Information

### Technical Information & Dimensions

#### Needle Valves

Spears® low-extractable needle valves provide proportional opening to needle travel for more accurate metering and other fine-adjustment flow-control applications. Replaceable PTFE seat eliminates all elastomer seals. Available in Globe and Angle pattern configurations with socket or threaded end connections. Valves include built-in panel mounting nut and easy-grip polypropylene handles.

#### Lab Fixtures (not shown)

See Part I of this catalog, High Purity PVC System for additional information.

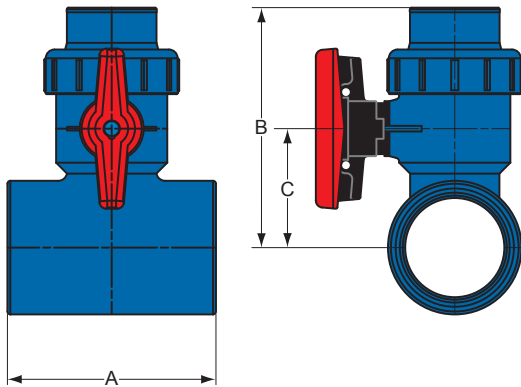

#### Needle Valves

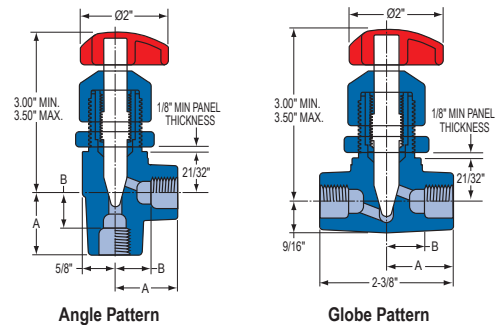

Globe Pattern Part #	Angle Pattern Part #	End Connection	Size (in.)	A	B
5592-002BL	5692-002BL	Socket	1/4	1-3/16	9/16
5592-003BL	5692-003BL	Socket	3/8	1-3/16	7/16
5592-005BL	5692-005BL	Socket	1/2	1-3/8	1/2
5591-002BL	5691-002BL	Threaded	1/4	1-3/16	21/32
5591-003BL	5691-003BL	Threaded	3/8	1-3/16	9/16
5591-005BLSR	5691-005BLSR	SR Threaded	1/2	1-3/8	21/32

**NOTE:** Spears® low-extractable Needle Valves carry a maximum pressure rating of 235 psi, non-shock, @ 73°F. Threaded 1/2" valve only available with Special Reinforced (SR) female threads.

#### True Union 2000 Industrial Tee-Style Ball Check Valves

Part # EPDM O-rings	Part # FKM O-rings	Nominal Size	Dimension Reference (inches + 1/16)			Weight (lbs.)
			A	B	C	
182901-005BL	183901-005BL	1/2	2-5/16	3-3/4	1-5/8	.48
182901-007BL	183901-007BL	3/4	3-7/16	4-1/4	1-7/8	.70
182901-010BL	183901-010BL	1	4	4-11/16	2-1/16	1.10
182901-012BL	183901-012BL	1-1/4	4-1/4	5-5/16	2-7/16	1.64
182901-015BL	183901-015BL	1-1/2	5-1/8	6-1/8	3	2.26
182901-020BL	183901-020BL	2	5-7/8	7-5/16	3-7/16	3.72
182901-101BL	183901-101BL	3/4x1/2	3-3/16	3-7/8	1-3/4	.51
182901-130BL	183901-130BL	1x1/2	3-7/16	4	1-7/8	.58
182901-131BL	183901-131BL	1x3/4	3-11/16	4-3/8	2	.78
182901-166BL	183901-166BL	1-1/4x1/2	4-1/4	4	1-7/8	.77
182901-167BL	183901-167BL	1-1/4x3/4	4-1/4	4-1/4	1-7/8	.90
182901-168BL	183901-168BL	1-1/4x1	4-1/4	4-13/16	2-3/16	1.78
182901-209BL	183901-209BL	1-1/2x1/2	4-3/8	4-1/4	2-1/8	.86
182901-210BL	183901-210BL	1-1/2x3/4	4-1/8	4-5/8	2-3/16	.91
182901-211BL	183901-211BL	1-1/2x1	4-1/2	5	2-3/8	1.37
182901-247BL	183901-247BL	2x1/2	4-3/16	4-9/16	2-7/16	1.06
182901-248BL	183901-248BL	2x3/4	4-3/8	4-15/16	2-9/16	1.23
182901-249BL	183901-249BL	2x1	4-3/4	5-1/4	2-5/8	1.38
182901-251BL	183901-251BL	2x1-1/2	5-7/8	6-1/16	2-15/16	2.33
182901-333BL	183901-333BL	3x1/2	5-1/2	5-1/8	3	1.60
182901-335BL	183901-335BL	3x1	5-1/2	5-7/8	3-1/4	2.19
182901-337BL	183901-337BL	3x1-1/2	7-1/4	6-9/16	3-7/16	3.66
182901-338BL	183901-338BL	3x2	6-11/16	7-11/16	3-13/16	4.61
182901-417BL	183901-417BL	4x1	7-7/16	6-5/16	3-11/16	3.25
182901-419BL	183901-419BL	4x1-1/2	7-3/8	7-5/16	4-3/16	4.01
182901-420BL	183901-420BL	4x2	7-3/4	8-5/16	4-7/16	5.20
182901-528BL	183901-528BL	6x2	10-3/16	9-5/8	5-3/4	9.26
182901-578BL	183901-578BL	8x2	15-5/8	12-5/8	8-3/4	17.42

#### Tee-Style Ball Valves

Spears® low-extractable True Union Tee-Style Ball Valve design integrates valve and Tee-fitting for direct branch take-off laterals. The close proximity of the valve to mainline emulates a "zero deadleg" design to minimize any areas of fluid stagnation. Custom produced to specified Tee and Valve connection sizes.



## System Design & Installation

### Product Ratings and Capability

Spears® low-extractable piping is produced to Schedule 80 dimensions in strict accordance with ASTM D 1785, and exhibits a Type II pressure rating. Fittings are produced to Schedule 80 dimensions per ASTM D 2467. Joining of product produced to the dimensional requirements of these standards ensures that strong connections with good pressure-bearing capability can be made up quickly and consistently using common, inexpensive tools. Utilizing these dimensions provides a higher pressure-bearing capacity compared to other "clean" systems on the market, and permits the use of standard socket dimensions.

### Dimensions

Nominal Pipe Size (in.)	Average O.D.	Average I.D.	Minimum Wall	Nominal Weight Lbs./ft.	Max.W.P. PSI*
1/2	.840	.528	.147	.202	420
3/4	1.050	.724	.154	.273	340
1	1.315	.935	.179	.402	320
1-1/4	1.660	1.256	.191	.554	260
1-1/2	1.900	1.476	.200	.673	240
2	2.375	1.913	.218	.932	200
3	3.500	2.864	.300	1.903	190
4	4.500	3.786	.337	2.782	160
6	6.625	5.709	.432	5.313	140

\*PSI water, non-shock @ 73°F with solvent-welded connections. System pressure rating dependent on component pressure ratings (i.e., flanges all sizes = 150 psi max @ 73° F)

### Temperature De-rating Factor

Operating Temperature (°F)	De-rating Factor
73	1.00
80	0.88
90	0.75
100	0.62
110	0.51
120	0.40
130	0.31
140	0.22

As with all schedules of thermoplastic pipe, pressure rating is dependent on the pipe diameter as well as the operating temperature of the system. As temperatures rise, the pressure rating of the system decreases. The maximum temperature rating of Spears® low-extractable piping is 140°F. However, **DO NOT** use with "hot" Deionized (DI) water as this may have a detrimental effect on the system. Spears® recommends that Low Extractable PVC systems used with deionized water should be limited operating temperatures of no more than 80°F. Smaller-diameter piping can withstand higher pressure than large-diameter piping at elevated temperatures. Use appropriate temperature de-rating factors to determine maximum allowable pressure at elevated temperatures.

### Hangers and Supports

Proper support spacing is critical to ensure that deflection is kept to a minimum. Support location and spacing is dependent on the pipe diameter, operating temperature of the system, and the location of any concentrated stress loads (i.e., valves, flanges, test equipment and any other heavy system components). Hangers used must have an adequate load-bearing surface free of any rough or sharp edges that could damage the pipe during use. Hangers also must not restrict linear movement of the system due to the effects of thermal expansion and contraction as a result of temperature changes; over-tightening must be avoided.

### Hanger Support Spacing

Pipe Size (in.)	Maximum Support Spacing in Feet				
	73°F	80°F	100°F	120°F	140°F
1/2	5	4-1/2	4-1/2	3	2-1/2
3/4	5-1/2	5	4-1/2	3	2-1/2
1	6	5-1/2	5	3-1/2	3
1-1/4	6	6	5-1/2	3-1/2	3
1-1/2	6-1/2	6	5-1/2	3-1/2	3-1/2
2	7	6-1/2	6	4	3-1/2
3	8	7-1/2	7	4-1/2	4
4	9	8-1/2	7-1/2	5	4-1/2
6	10	9-1/2	9	6	5



### Thermal Expansion and Contraction

As with all thermoplastic piping materials, expansion must be given during the design of the system to the effects of thermal expansion and contraction. The coefficient of linear expansion for Spears® low-extractable pipe is  $3.89 \times 10^{-5}$  in./in./°F. The rate of expansion or contraction can be calculated as follows:

$$\Delta L = 12 \gamma L (T)$$

Where:

$\Delta L$  = amount of expansion or contraction in inches

$$\gamma = 3.89 \times 10^{-5}$$

L = length of piping run in feet

$\Delta T$  = temperature change °F

(T max. - T @ time of installation or lowest system temperature or maximum system temperature, whichever is greater.)

### Storage and Handling

Reasonable care and common sense should be used when handling and storing Spears® low-extractable piping products. These products are tough and corrosion resistant, but they should not be dropped or have objects dropped on them. Care should be used when transporting and storing the product to prevent physical damage. Spears® low-extractable products should not be stored or installed close to heat-producing sources, subjected to external loads or over stacked when stored. The product should be inspected for any scratches, splits or gouges. Damaged sections must be cut out and discarded.





## High Purity- Low Extractable PVC System Technical Information

### Technical Information & Dimensions

#### Joining Techniques

Spears® low-extractable piping products are easily joined by the solvent-cementing process. Unlike conventional PVC solvent-cementing techniques, this product utilizes a **one-step solvent-cement system specifically formulated for “clean” applications**. This solvent cement exhibits extremely fast set and cure times. When properly used, this system results in very short cure times prior to pressure testing, and produces a solvent-cemented assembly with an exceptionally low percentage of chemical additives, reducing the potential for system contamination.

A thorough understanding of the solvent cement joining process and proper assembly techniques must be used during assembly of these products to ensure the highest system integrity. Installers must become familiar with this process prior to use.

#### Basic Principles of Solvent Cementing

Spears® low-extractable components are manufactured to the dimensional tolerances for Schedule 80 pipe per ASTM D 1785, and Schedule 80 socket-type fittings per ASTM D 2467. When fittings are produced to these dimensions, the ID of the fitting at the entrance of the socket is larger than the ID of the fitting at the socket bottom. The taper created by fitting socket dimensions provides an interference fit during assembly of the components. This provides a proven means for proper mating of components, ensuring adequate joint strength when properly assembled.



The following points must be clearly understood to ensure satisfactory joints are obtained consistently.

1. The joining surfaces must be softened and made semifluid.
2. Sufficient cement must be applied to fill the gap between the pipe and fitting.
3. Assembly of pipe and fitting must be made immediately while the surfaces are still wet and the cement is fluid.
4. Joint strength develops quickly as the cement dries. In the tight part of the joint, the surfaces will tend to fuse together; in the loose part of the joint the cement will bond to both surfaces.

These areas must be softened and penetrated

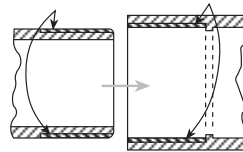

#### Softening and Penetration

These areas must be softened and penetrated. (This can be achieved by the cement itself.)

Cement coatings of sufficient thickness

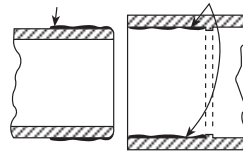

#### Sufficient Application of Cement

More than sufficient cement to fill the gap in the loose part of the joint must be applied. In addition to filling the gap, adequate cement layers will penetrate the joining surfaces and remain fluid until the joint is assembled.

#### Joint Integrity

When the cement coating on the pipe and fittings are fluid during assembly, they will tend to flow together and become one cement layer. In addition, the surfaces beneath the cement coating will be soft from surface penetration of the cement. The softened surface areas in the tight part of the joint will tend to fuse together. As the solvent dissipates, the cement layer and the softened surfaces will harden with a corresponding increase in joint strength. The dissipation of the solvent from specially formulated one-step cement occurs very quickly due to its high evaporation rate. Joint strength develops more quickly in the tight (fused) part of the joint than in the looser (bonded) part of the joint. A properly assembled joint will take the required working pressure before the joint is fully dry and final joint strength is obtained.

Surfaces must be assembled while they are wet and soft

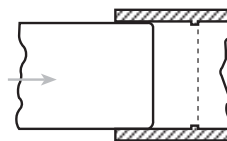

Bonded Surfaces

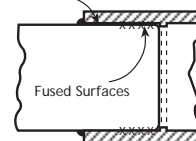

#### Specially Formulated One-Step Cement

Use only specially formulated one-step cement for Spears® low-extractable applications using the appropriate size applicator. Carefully read and follow the label on the cement can, and application and cure time instructions thoroughly. **NOTE:** Dauber is supplied in pint-can lid (suitable for pipe sizes 1/2" - 1-1/4"). Dauber is supplied in quart-can lid (suitable for pipe sizes 1-1/2" - 3"). For pipe sizes 4" thru 6" use a roller equal in size to 1/2 the pipe diameter.

Specially formulated one-step cement is listed by NSF International and conforms to the requirements of ASTM D 2564.





### Safety Precautions:

Before applying cement, appropriate safety precautions should be taken. Solvent cement should be stored in the shade between 40°F and 110°F. Eliminate all ignition sources. Avoid breathing of vapors. Use only with adequate ventilation; mechanical ventilation or local exhaust is recommended to maintain vapor concentrations below exposure limits. In confined or partially enclosed areas an organic vapor respirator is recommended. Containers should be kept tightly closed when not in use, and covered as much as possible when in use. Avoid frequent contact with skin. Wear clean rubber gloves; do not perform work with bare hands.

### Component Preparation:

All pipe, fittings and tools used for joining must be clean and free of dirt, moisture, grease or other contamination prior to and during the joining process.

#### 1. Cutting:

Cutting the pipe as squarely as possible (90°) is required, as it maximizes the bonding area of the joint. Only sharp wheel-type cutters with blades specifically designed for cutting plastic shall be used. Cutters should be rotated slowly to provide optimum cut. Cutting speeds should be further reduced at lower temperatures. The use of a saw is *not* recommended as filings and shavings will cause particulate contamination.

#### 2. Deburring:

All pipe ends shall be properly chamfered by providing a 10° to 15° bevel (1/16" to 3/32" in width). A chamfering tool designed for this purpose shall be used. A proper bevel will aid in assembly and prevent solvent cement being pushed from the wall of the fitting during assembly. Burrs and filings can prevent contact between the pipe and fitting and must be removed from the outside and inside of the pipe during this process. A common practice is to place sterile gauze in the pipe end to prevent shavings from entering the pipe. The gauze is then removed prior to cement application.

#### 3. Joining Preparation:

- A. Prior to assembly, all components shall be inspected for any damage or irregularities. Mating components shall be checked to assure that tolerances and engagements are compatible. Do not use components that appear irregular or do not fit properly.
- B. Check the dry fit – The pipe should enter the fitting socket easily one-quarter to three-quarters of the way. If the pipe bottoms in the fitting with little interference, use extra solvent cement in making the joint.
- C. Measure the socket depth of the fitting and mark this distance on the pipe end. This reference mark can be used when joining to ensure the pipe is completely bottomed into the fitting during assembly.

#### 4. Solvent Cement Application:

Specially formulated one-step cement shall be applied to the joining surfaces using a dauber or natural-bristle brush approximately half the diameter of the pipes being joined. Working quickly, apply a heavy, even coat of solvent cement to the pipe end on the surface equal to the depth of the fitting socket. Apply a light coat to the fitting socket. If there was little interference during the dry fit, apply a second coat of cement to the pipe end at this time. Great care must be used to prevent cement from coming into contact with the interior waterway of the fitting or pipe.

#### 5. Assembly:

Immediately insert the pipe into the fitting socket while rotating one-quarter turn. Properly align the fitting for the installation at this time. The pipe must bottom completely to the fitting stop. Hold the assembly for approximately 30 seconds to ensure initial bonding. Due to the taper on the interference fit, the pipe can back off the fitting stop if steady pressure is not held on the joint during initial bonding. A bead of cement should be evident around the pipe and fitting juncture. If the bead is not continuous, it may indicate that insufficient cement was applied. *Due to the unique translucency of Spears® low-extractable products, visual inspection of the cemented joint can be conducted utilizing a flashlight or alternate light source. Joint integrity can be readily verified by visually inspecting the cemented surfaces for uniformity.* If insufficient cement is applied, the joint must be cut out, discarded and begun again. Excess cement must be wiped off from the pipe OD using a clean rag at this time.







## Assembly Instructions

### Set and Cure Times:

Set and cure times are a function of pipe size, temperature, pressure, humidity and tightness of fit. The initial **set time** is the recommended waiting period prior to handling a newly assembled joint. After the initial set time, the joints will withstand the stresses of normal installation. (Misalignment of components during assembly will cause excessive stress in the joint, which can affect joint integrity). The **cure time** is the recommended waiting period prior to pressurizing newly assembled joints. Minimum cure time prior to pressure testing is dependent on pipe size, temperature, humidity, tightness of fit and test pressure required. Longer cure times must be allowed when working at higher humidity and colder temperatures.

Refer to the following tables for minimum set and cure times:

### Initial Set Time

Temp.	Pipe Size 1/2 - 1-1/4	Pipe Size 1-1/2 - 2	Pipe Size 2-1/2 - 6
60° - 100°F	2 minutes	3 minutes	30 minutes
40° - 60°F	5 minutes	8 minutes	2 hours
0° - 40°F	10 minutes	15 minutes	12 hours

### Joint Cure Schedule

Relative Humidity 60% or less*	Pipe Size 1/2 - 1-1/4		Pipe Size 1-1/2 - 2		Pipe Size 2-1/2 - 6
Temp range during assembly and cure periods	up to 160 psi	160 to 360 psi	up to 160 psi	160 to 315 psi	up to 160 psi
60° - 100°F	15 min	6 hrs	25 min	12 hrs	1-1/2 hrs
40° - 60°F	20 min	12 hrs	30 min	24 hrs	4 hrs
0° - 40°F	30 min	48 hrs	45 min	96 hrs	72 hrs

\* If damp or humid weather allow 50 percent longer cure time.

## Other Design Considerations

Proper system engineering, design, construction practices and operation are the responsibility of the design authority. Consideration must be given to ensure the Spears® low-extractable system is not exposed to any conditions that will exceed the product limitations regarding temperature, pressure, chemical compatibility, and mechanical strength. Detailed chemical resistance and other design information is available from Spears® Manufacturing Company.

**DO NOT** use with "hot" Deionized (DI) water as this may have a detrimental effect on the system. Spears® recommends that Low Extractable PVC systems used with deionized water should be limited operating temperatures of no more than 80°F.

Spears® Manufacturing Company does not recommend the use of this product for the transportation or storage of compressed air or gases, nor the testing of these systems using compressed air or gases.

Excessive surge pressure must be avoided. The system must be designed to ensure that surge potentials generated by pump operation, entrapped air, flow velocity, and valve closure are kept to a minimum. Spears® does not recommend flow velocities in excess of five feet per second.

### Flange Installation:

1. Solvent cement flange to pipe.
2. Piping runs joined must be installed in straight-line position to the flange and supported to avoid stress and damage.
3. Rotate ring into position with gasket in place to align holes.
4. Insert all bolts, washers and nuts.
5. Mating surfaces of flanges must be flush against gasket prior to bolting.
6. Tighten by hand until snug. Tighten bolts in 5 ft.-lb. increments according to opposing sequence shown below.
7. Do not use bolts to bring improperly mated flanges together.

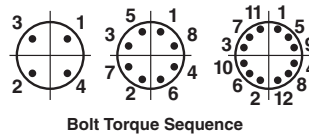

Flange Size (in)	Recommended Torque
1/2 - 1-1/2	12 ft-pounds
2 - 4	25 ft-pounds
6	40 ft-pounds

### Installation Notes:

Installers should verify for themselves that they can make satisfactory joints under varying conditions.

Use the appropriate size applicator. Avoid puddling of solvent cement on or within fittings and pipe. This will cause excessive softening of materials, resulting in damage to the product and excessive system contamination.

Spears® low-extractable solvent-cemented assemblies cure very quickly when properly constructed, enabling pressure-bearing capability in a short time. This is a positive attribute of the system for scheduling pressure tests and repair work. However, Spears® Manufacturing Company recommends that newly assembled systems be allowed to cure for a minimum period of 24 hours prior to system rinsing/activation procedures. This reduces the potential for TOC contamination.

Spears® low-extractable piping products should not be connected directly to UV light sources that would expose system components to ultraviolet radiation.

Spears® low-extractable piping systems are not formulated for outdoor use. Prolonged exposure to ultraviolet radiation (UVR) will affect physical properties.

Spears® Manufacturing Company recommends that newly installed systems be allowed to cure for a minimum period of 24 hours prior to rinsing procedures to reduce the potential for TOC contamination. Rinsing procedures, chemical rinse and other cleanup/disinfection procedures to be used are at the discretion of the system design authority. Note: Spears® low-extractable piping is compatible with hydrogen peroxide at concentrations up to 30% at 73°F. Contact Spears® for additional chemical compatibility information concerning the use of these products with various substances prior to use.



## Sample Specifications

UPW process piping and fittings shall be manufactured from a specialty low-extractable, Polyvinyl Chloride (PVC) compound with a Cell Classification of 12343 per ASTM D 1784. All pipe and fittings shall be produced to Schedule 80 dimensions, manufactured in strict compliance to ASTM D 1785 (pipe), and ASTM D 2467 (fittings). These products shall carry a Type II pressure rating and consistently meet or exceed the applicable Quality Assurance test requirements of these standards with regard to dimensions, workmanship, burst pressure, flattening resistance and end-product quality. All UPW process valves shall be True Union-style diaphragm or True Union-style quarter-turn ball valves produced from the same low-extractable PVC compound. All valve diaphragms and seats shall be PTFE; valve O-rings shall be EPDM or FKM as applicable. All valve union nuts shall have buttress-style threads. All valve components shall be replaceable. System components shall be joined utilizing specially formulated one-step cement for joining the system. All system components shall be manufactured in the USA by an ISO-certified manufacturer. All UPW piping shall be bagged and sealed immediately after manufacture to maintain cleanliness, and boxed and stored indoors at the manufacturing facility until shipped from the factory. UPW process pipe and UPW piping components shall be those as provided by Spears® Manufacturing Company.



*The data furnished herein is provided as a courtesy and is based on past experience, limited testing, and other information believed to be reliable. This information may be considered as a basis for recommendation only. No guarantee is made as to its accuracy, suitability for particular applications, or the results to be obtained therefrom. Materials should be tested under actual service conditions to determine suitability for a particular purpose.*

"Lead Free" low lead certification – unless otherwise specified, all Spears® Low-Extractable piping and fittings specified here-in are certified by NSF International to ANSI/NSF® Standard 61, Annex G and is in compliance with California's Health & Safety Code Section 116825 (commonly known as AB1953) and Vermont Act 193. Weighted average lead content  $\leq 0.25\%$ .