

DISTRIBUTION
for
Design Configuration Control Document
LIGO-C961574-00-0

B. Althouse	F. Asiri	B. Barish	M. Coles
D. Coyne	C. Franklin	L. Jones	A. Lazzarini
P. Lindquist	B. Lucas	O. Matherny	F. Raab
G. Sanders	R. Savage	D. Shoemaker	A. Sibley
G. Stapfer	B. Tyler	R. Vogt	R. Weiss
S. Whitcomb	J. Worden	M. Zucker	DCC

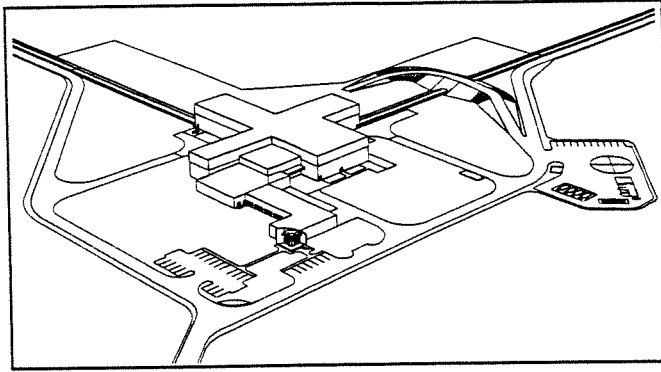

Civil Construction

Facilities

Design Configuration Control Document Final Issue

July 3, 1996

LIGO

Laser Interferometer Gravitational-Wave Observatory

California Institute of Technology

Parsons Infrastructure and Technology Group

Contract Number: PP150969

LIGO Document	960703-0
CDRL Number	08
DRD Number	03
Revision	06

APPROVAL STATUS

YES

NO

NOT REQUIRED

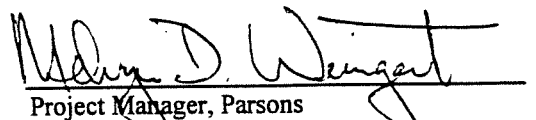
Project Manager, Parsons

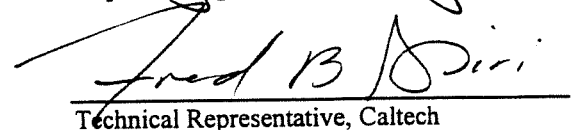
Technical Representative, Caltech

Parsons-LIGO 

Laser Interferometer Gravitational-Wave Observatory

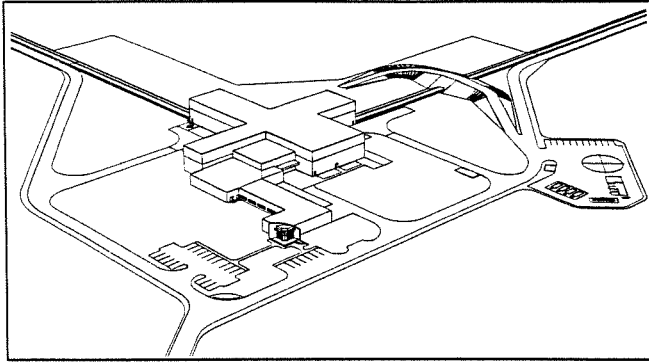

Civil Construction

Facilities

Design Configuration Control Document

Final Issue

July 3, 1996

LIGO

Laser Interferometer Gravitational-Wave Observatory

California Institute of Technology

Parsons Infrastructure and Technology Group

Contract Number: PP150969

LIGO Document	960703-0
CDRL Number	08
DRD Number	03
Revision	06

APPROVAL STATUS

YES

NO

NOT REQUIRED

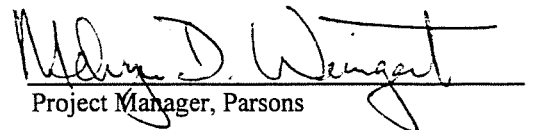
Project Manager, Parsons

Technical Representative, Caltech

Parsons-LIGO 

Laser Interferometer Gravitational-Wave Observatory

1. Introduction	1-1
1.1 Scope.....	1-1
1.2 Facility Overview.....	1-2
1.3 Scope Exclusions.....	1-3
1.3.1 Beam Tube System.....	1-3
1.3.2 Vacuum Equipment System.....	1-3
1.3.3 Detector System.....	1-3
1.4 Growth and Flexibility.....	1-4
1.4.1 Laser and Vacuum Equipment Area.....	1-4
1.4.2 Operations Support Building.....	1-4
2. Design Requirements and Criteria	2-1
2.1 General.....	2-1
2.1.1 Fabrication and Construction Tolerances.....	2-1
2.1.2 Service Life.....	2-1
2.1.3 Construction Category.....	2-1
2.1.4 Occupancy.....	2-1
2.1.5 Design.....	2-2
2.1.6 Safety.....	2-2
2.1.7 Security.....	2-2
2.1.8 Material Selection.....	2-2
2.2 Civil.....	2-3
2.2.1 General Civil Requirements.....	2-3
2.2.2 Coordinate Control.....	2-3
2.2.3 Site Preparation and Earthwork.....	2-6
2.2.4 Roads, Paving, and Parking.....	2-6
2.2.5 Site Drainage.....	2-8
2.2.6 Utilities.....	2-9
2.2.7 Wastewater Treatment Facilities.....	2-10
2.2.8 Miscellaneous Sitework.....	2-10
2.3 Structural.....	2-11
2.3.1 General Structural Requirements.....	2-11
2.3.2 Loading Conditions.....	2-11
2.4 Architectural.....	2-14
2.4.1 Laser and Vacuum Equipment Area.....	2-14
2.4.2 Operations Support Building.....	2-15
2.4.3 Mechanical Room.....	2-20
2.4.4 Chiller Plant at Corner Station.....	2-20
2.4.5 Mid and End Station Facilities.....	2-20
2.4.6 Beam Tube Enclosures.....	2-21
2.4.7 Finishes.....	2-22
2.4.8 Doors -- General.....	2-25
2.4.9 "Clean Environment" Interior Design.....	2-27
2.4.10 Roofs and Gutters.....	2-27
2.4.11 Life Safety.....	2-27
2.4.12 Energy Conservation.....	2-27
2.5 Mechanical.....	2-28

2.5.1 General Mechanical Requirements	2-28
2.5.2 Heating, Ventilating, and Air Conditioning Systems	2-29
2.5.3 Plumbing Systems	2-36
2.5.4 Fire Suppression and Detection Systems.....	2-37
2.5.5 Facility Monitoring and Control Systems.....	2-38
2.5.6 Cranes	2-40
2.6 Electrical	2-42
2.6.1 Area Classification.....	2-42
2.6.2 Site Power.....	2-42
2.6.3 Electrical Equipment	2-42
2.6.4 Receptacles	2-42
2.6.5 Lighting	2-43
2.6.6 Crane.....	2-44
2.6.7 Electrical Power Characteristics	2-44
2.6.8 Materials	2-47
2.6.9 Grounding.....	2-47
2.6.10 Fire Detection System.....	2-50
2.6.11 Doors and Controls.....	2-50
2.6.12 Optics and Vacuum Preparation and Assembly Labs.....	2-50
2.6.13 Facility Control Room, Diagnostics Area, Computer Users Area, Computer and Mass Storage Room	2-50
2.6.14 Beam Tube Enclosures	2-50
2.6.15 Electromagnetic Compatibility (EMC).....	2-51
2.6.16 Communication Systems	2-51
2.7 Vibration Isolation	2-52
2.8 Acoustics	2-55
2.8.1 Laser Facility and End Stations Background Noise	2-55
2.8.2 Offices Space Background Noise	2-55
2.8.3 Reverberation Times.....	2-55
2.8.4 Exterior to Interior Noise Control.....	2-55
2.9 Verification and Testing	2-55
2.9.1 Verification Methods.....	2-56
2.9.2 Requirements and Procedures.....	2-56
2.9.3 Mechanical	2-57
2.9.4 Electrical Tests	2-57
2.9.5 Architectural.....	2-59
2.9.6 Vibration Testing.....	2-59
2.9.7 Acoustics	2-60
3. Hanford Design Description	3-1
3.1 General	3-1
3.1.1 Laser and Vacuum Equipment Area.....	3-1
3.1.2 Operation Support Building.....	3-1
3.1.3 Mechanical Equipment Rooms.....	3-3
3.1.4 Chiller Plants and Utility Buildings.....	3-3
3.1.5 Mid Station and End Station.....	3-3
3.1.6 Global and Local Coordinate System Reference	3-4
3.1.7 Building Code Analysis.....	3-4
3.1.8 Building Security.....	3-6
3.2 Civil	3-6

3.2.1 Potable Water Supply and Treatment	3-6
3.2.2 Sanitary Sewage Disposal.....	3-6
3.2.3 Firewater Supply.....	3-7
3.2.4 Access Road	3-7
3.2.5 Site Roads.....	3-7
3.2.6 Parking Areas	3-8
3.2.7 Grading and Drainage.....	3-8
3.2.8 Erosion Protection	3-8
3.2.9 Fencing and Gates	3-9
3.3 Structural.....	3-9
3.3.1 Chiller Plants	3-9
3.4 Architectural.....	3-9
3.4.1 Interior Materials and Finishes	3-9
3.4.2 Exterior Siding.....	3-11
3.4.3 Roofing.....	3-11
3.4.4 Clean environments	3-11
3.5 Mechanical.....	3-13
3.5.1 Interior Environmental Control	3-15
3.5.2 House Cleaning Vacuum System	3-17
3.5.3 Clean/Dry Instrument Air.....	3-18
3.5.4 Fire Protection Systems	3-18
3.5.5 Plumbing Systems	3-19
3.5.6 Mechanical Specialties	3-19
3.6 Electrical.....	3-20
3.6.1 Electrical Power Distribution	2-20
3.6.2 Grounding.....	3-22
3.6.3 Lightning Protection	3-23
3.6.4 Lighting	3-23
3.6.5 Communications.....	3-23
3.6.6 Instrumentation and Controls	3-24
3.7 Vibration.....	3-28
3.7.1 LVEA, OSB, and Associated Superstructure	3-29
3.7.2 Chiller Plants	3-32
3.7.3 Mid and End Stations	3-33
3.7.4 Equipment Isolation Recommendations	3-33
3.8 Acoustic.....	3-35
3.8.1 Interior Acoustics	3-35
3.8.2 HVAC Noise Control	3-35
3.8.3 Exterior-to Interior Noise Control	3-35
3.9 Interface.....	3-35
3.9.1 Vacuum Equipment System	3-36
3.9.2 Beam Tube System.....	3-37
3.9.3 Detector System.....	3-38
4. Referenced Documents	4-1
4.1 Federal Standards	4-1
4.2 Military Standards.....	4-1
4.3 Industry Standard Codes.....	4-1

4.4 Industry Standard Specifications, and Guidelines	4-2
4.5 Site Specific Reference Documents -- General.....	4-7
4.6 Site Specific Reference Documents -- Hanford	4-7
4.7 Site Specific Reference Documents -- Livingston.....	4-8

Figures

Figure 2.2-1 -- Hanford Property Boundaries (For Reference Only).....	2-4
Figure 2.2-2 -- Livingston Property Boundaries (For Reference Only).....	2-5
Figure 2.4-1 -- Cut-Away of Beam Tube Enclosure	2-22
Figure 2.7-1 -- Ambient PSD Predictions	2-54
Figure 3.1-1 -- Layout of LVEA Areas and Mechanical Room.....	3-1
Figure 3.5-2 -- Layout of LVEA Areas and Bridge Cranes	3-19
Figure 3.7-1 -- Hanford Corner Station West Axis, Late Night December 12, 1994.....	3-30
Figure 3.7-2 -- Hanford Corner Station West Axis, Morning Traffic December 13, 1994.....	3-31

Tables

Table 2.1-1 -- Staff List.....	2-1
Table 2.3-1 -- BTE Projectile Data	2-14
Table 2.5-1 -- Climatic Design Criteria.....	2-30
Table 2.5-2 -- Inside Design Conditions During Normal Operational Mode.....	2-31
Table 2.5-2 -- Inside Design Conditions During other Modes.....	2-31
Table 2.6-1 -- Illumination Levels	2-43
Table 2.6-2 -- Facility Power Characteristics.....	2-45
Table 2.6-3 -- Technical Power Characteristics	2-45
Table 2.6-4 -- UPS Power Characteristics.....	2-46
Table 2.8-1 -- LVEA/VEA Acoustic Requirements.....	2-55
Table 3.1-1 -- OSB Square Footage Summary	3-3
Table 3.4-1 -- Room Finish Schedule	3-10
Table 3.5-1 -- Utility Matrix	3-13
Table 3.6-1 -- Power Demands for Interferometer, Vacuum Equipment, and Beam Tube Systems	3-22
Table 3.6-2 -- Facility Monitoring and Control System Nodes.....	3-26
Table 3.9-1 -- Interface with Interferometer, Vacuum Equipment, and Beam Tube Systems	3-40

Appendixes

Appendix A -- Abbreviations

1. Introduction

1.1 Scope

The Design Configuration Control Document (DCCD) establishes a baseline and is a configuration control document from which the design of the Facility evolved. As the design evolved, this document was updated. This identifies the final criteria and design for both the Hanford and Livingston facilities.

The contents of the DCCD include the following key discussions:

Section 1 -- Introduction

Section 2 -- Design Requirements and Criteria

Section 3 -- Design Description

Section 2 establishes baseline design requirements and criteria for the Laser Interferometer Gravitational-Wave Observatory (LIGO) Facility Design. This baseline information was developed from:

- Appendixes A, B, and C of the LIGO Facility Request for Proposal No. YM 193
- Exhibit I of the LIGO Vacuum Equipment Request for Proposal No. MH 178
- Tiger-team meetings
- Comments on previously submitted drafts of this document
- 90% Concept Design Report
- Final Concept Design Report
- Facility and beam tube enclosure trade studies
- LIGO and Parsons technical interchange meetings
- Industry standard design and construction practices that will meet or exceed these needs
- Technical Direction Memoranda (TDM)
- Preliminary Design Report (PDR) - Reviewer Comments
- On-Board Reviews

By reference, criteria provided in Appendixes A, B, and C of the LIGO Facility Request for Proposal Number YM 193, and Exhibit I (LIGO Document 1100003) of the LIGO Vacuum Equipment Request for Proposal Number MH 178 constitute a component of this document and are therefore considered an element of the Facility's controlled design configuration. Concept strawman design approaches presented in these RFPs are not an element of the

controlled design configuration; however, the layouts of the Vacuum Equipment in the LVEA and VEAs are considered a controlled design configuration.

Section 3 does not reiterate design requirements or criteria. Its purpose is to illustrate the design solutions which meet the requirements and criteria established in Section 2. This Section discusses design solutions for both Sites generically. If there are difference to the design solutions for the two Sites, the differences are explained.

1.2 Facility Overview

The LIGO project is a pioneering effort to design and construct a novel scientific facility -- a gravitational-wave observatory -- that will open a new observational window on the universe.

LIGO will consist of two observatory facilities. One will be located at Hanford, Washington, and the other at Livingston, Louisiana. These facilities will incorporate L-shaped vacuum systems with arms 4 km in. length. The vacuum systems (by Others) will house laser interferometer detectors sensitive to gravitational waves generated by astrophysical sources. Initial detector sensitivity will detect strains as small as 10^{-22} . Correlation of data from interferometers at the two Sites will allow identification of gravitational waves, and their sources and origin in space. LIGO will become the first part of a planned worldwide network of gravitational-wave detectors coordinated to operate as a single observatory complex.

Constructed Facilities at each Site include the main Corner Station, with the large Laser and Vacuum Equipment Area (LVEA), End, and Mid Stations (Mid-Point Pumping Station at Livingston) on each Beam Tube arm, and a Site Service Area with chillers, pumps, water tank, and other ancillary maintenance components. Building work includes, but is not limited to, earth work, power distribution, lighting, security systems, fire protection, communications, facility monitoring and control system, access platforms, clean environments, cranes, and heating, ventilating, and air conditioning. Each Site will have two Beam Tube Enclosure structures, each 4 km long. Sitework for the virgin Sites includes grading, drainage, roads, parking, landscaping, water supply developed from wells, sanitary facilities, waste water treatment and disposal and power distribution from area utilities.

Facility design will address special building requirements for the Laser and Vacuum Equipment Area located at the Corner Station, and Vacuum Equipment Areas at the Mid, and End Stations.

- Both Sites were selected based on their low ambient background vibration levels. Vibration isolation and reduction is required in order that transmitted vibration energy is as low as possible given the budgetary constraints. This requires seismic mass-type foundations for critical scientific equipment, and separate foundations and remote locations for vibration-producing equipment and occupancy.

- Laser and vacuum equipment will be located in a large open space of high volume and provided with cleanroom-type finishes but serviced by “conventional” air changes and quality.
- The laser interferometer detector is sensitive to EMI effects and will require special design for power, lighting, and control circuits to minimize disturbances.

1.3 Scope Exclusions

These systems will be designed, provided, and installed by Others and, in general, consist of the following items.

1.3.1 Beam Tube System

- a) Beam Tube Segments
- b) Expansion Bellows
- c) Pumping Ports
- d) Baffles (Internal to Beam Tube)
- e) Beam Tube Support and Leveling Subsystem
- f) Bake-out Subsystem
- g) GPS Positioning and Alignment Monitoring Subsystem

1.3.2 Vacuum Equipment System

- a) Vacuum Chamber Subsystem
- b) Pumping Subsystem
- c) Valve Subsystem
- d) Vent and Purge Subsystem
- e) Bake-out Subsystem
- f) Monitor and Control Subsystem

1.3.3 Detector System

- a) Interferometers
 - i) Lasers
 - ii) Optics
 - iii) Alignment and Length Sensing Systems
 - iv) Seismic Isolation Systems and Suspensions
- b) Control and Data System

- c) Physics Environmental Monitoring
- d) Support Equipment

1.4 Growth and Flexibility

1.4.1 Laser and Vacuum Equipment Area

The current Facility design does not preclude expansion of the laser and vacuum equipment area to accommodate a maximum of five interferometers at the Hanford site and three interferometers at the Livingston site.

For the Corner Stations, the current design accommodates expansion in the following way. It allows for construction of an additional LVEA space adjacent to the currently designed LVEA to house up to two more interferometers for the Hanford site (a total of five) and one more for the Livingston site (a total of three). However, the current design and construction package does not include any foundations, structures, mechanical capacities, or infrastructure required for this expansion.

For the End Stations the current design allows for expansion of the VEA spaces to accommodate up to four vacuum chambers for the Hanford site and three vacuum chambers for the Livingston site. However, the current design and construction package does not include any sitework, foundations, structure, mechanical capacities, or infrastructure required for this expansion.

1.4.2 Operations Support Building

The current Facility design also does not exclude the expansion of the Operations Support Building (OSB). This is accomplished in the current design by placing fixed functions (restrooms, kitchen, electrical, etc.) together in the area core, allowing the building to expand in most directions with minimum impact to the existing Facility. Temporary population surges at times of initial and future interferometer installation may be accommodated by adding temporary trailers in a designated area near the OSB.

2. Design Requirements and Criteria

2.1 General

- a) Units of measurement are expressed in the English system.
- b) Various Federal specifications shall be used as the Guideline Construction Specification.

2.1.1 Fabrication and Construction Tolerances

The A-E shall provide, in the drawings and specifications, all tolerances for fabrication, construction, and installation.

2.1.2 Service Life

2.1.2.1 Facility Design Life

Facility design shall be for a 30-year service life.

2.1.2.2 Systems and Equipment Design Life

Operating systems and equipment design shall be for a 20-year service life.

2.1.3 Construction Category

The LIGO project is categorized as permanent construction in accordance with Uniform Building Code (UBC) and NFPA 101 Life Safety Code.

2.1.4 Occupancy

Each LIGO project Site shall be designed for a maximum shift population of 40 people. The breakdown of anticipated personnel and their classification is as follows:

Staff	Quantity
Technicians and/or Operators	10
Technician Specialists	3
Engineers	3
Site Administration	2
Scientific Staff	3
Visiting Scientists	6
Interns and/or Visitors	9
Maintenance Personnel	4

Table 2.1-1 -- Staff List

In addition to the occupants listed above, other visitors, including tour groups of students, educators, scientists, and dignitaries, shall visit the Facility on a regular basis.

2.1.5 Design

Design of the Facility shall comply with the industry standards and specifications referenced herein and good design principles. The Facility shall be designed for low risk and ease of maintenance and operability.

2.1.6 Safety

Construction of the Facilities shall comply with OSHA- 29 CFR, and applicable local codes (e.g., Washington Institute of Safety and Health Administration (WISHA) at the Hanford Site).

2.1.7 Security

Security of the Facilities shall comply with good industrial practice. The major security effort shall be to design for minimum potential intrusion into the station buildings and Beam Tube Enclosures.

2.1.8 Material Selection

2.1.8.1 Flame Spread

All materials shall be non-combustible or have a flame spread rating of 25 or less in accordance with ASTM E84.

2.1.8.2 Cleanliness/Contamination

The following is a list of design criteria items that shall be applied to all interior spaces.

- a) Design shall use non-corrosive and/or corrosion resistant material as required.
- b) Exclude use of fraying or other material that could contribute to contamination in the Laser and Vacuum Equipment Area (LVEA), Vacuum Equipment Areas (VEAs), and all clean environments.
- c) Preclude ledges that may trap dirt and minimize oil leakage from mechanisms and mechanical equipment.
- d) Consideration shall be given to outgassing and particle generation of the materials. As a design goal, all material selections should be made to minimize Non Volatile Residue (NVR) deposition in the LVEA, and VEAs.

- e) All materials shall be compatible with the cleanliness requirements of the room's classification (see Section 2.4.9).

2.2 Civil

2.2.1 General Civil Requirements

Civil requirements shall include Site preparation and earthwork, hydrology and drainage, roads and paving, parking, utilities, wastewater treatment, and other Site improvements. Area contours shall be provided by LIGO's surveying Consultant for each Site.

Careful attention shall be paid to development of the Site to the special needs of LIGO and of the individual site characteristics. Establishing and maintaining alignment are important considerations at both Sites.

LIGO shall provide soil reports and allowable design parameters.

2.2.2 Coordinate Control

2.2.2.1 Hanford

The intersection of the two centerlines of the property arms is located at latitude $46^{\circ} 27' 18.5''\text{N}$ and longitude $119^{\circ} 24' 27.1''\text{W}$. The northwest arm is at a bearing of $\text{N}36.8^{\circ}\text{W}$ and the southwest arm is at a bearing of $\text{S}53.2^{\circ}\text{W}$ from the origin of the global coordinate system. For further coordinate and Site boundary information see Figure 2.2-1.

2.2.2.2 Livingston

The intersection of the two centerlines of the property arms is located at latitude $30^{\circ} 33' 46.0''\text{N}$ and longitude $90^{\circ} 46' 27.3''\text{W}$. The southeast arm is at a bearing of $\text{S}18^{\circ}\text{E}$ and the southwest arm is at a bearing of $\text{S}72^{\circ}\text{W}$ from the origin of the global coordinate system. For further coordinate and Site boundary information see Figure 2.2-1.

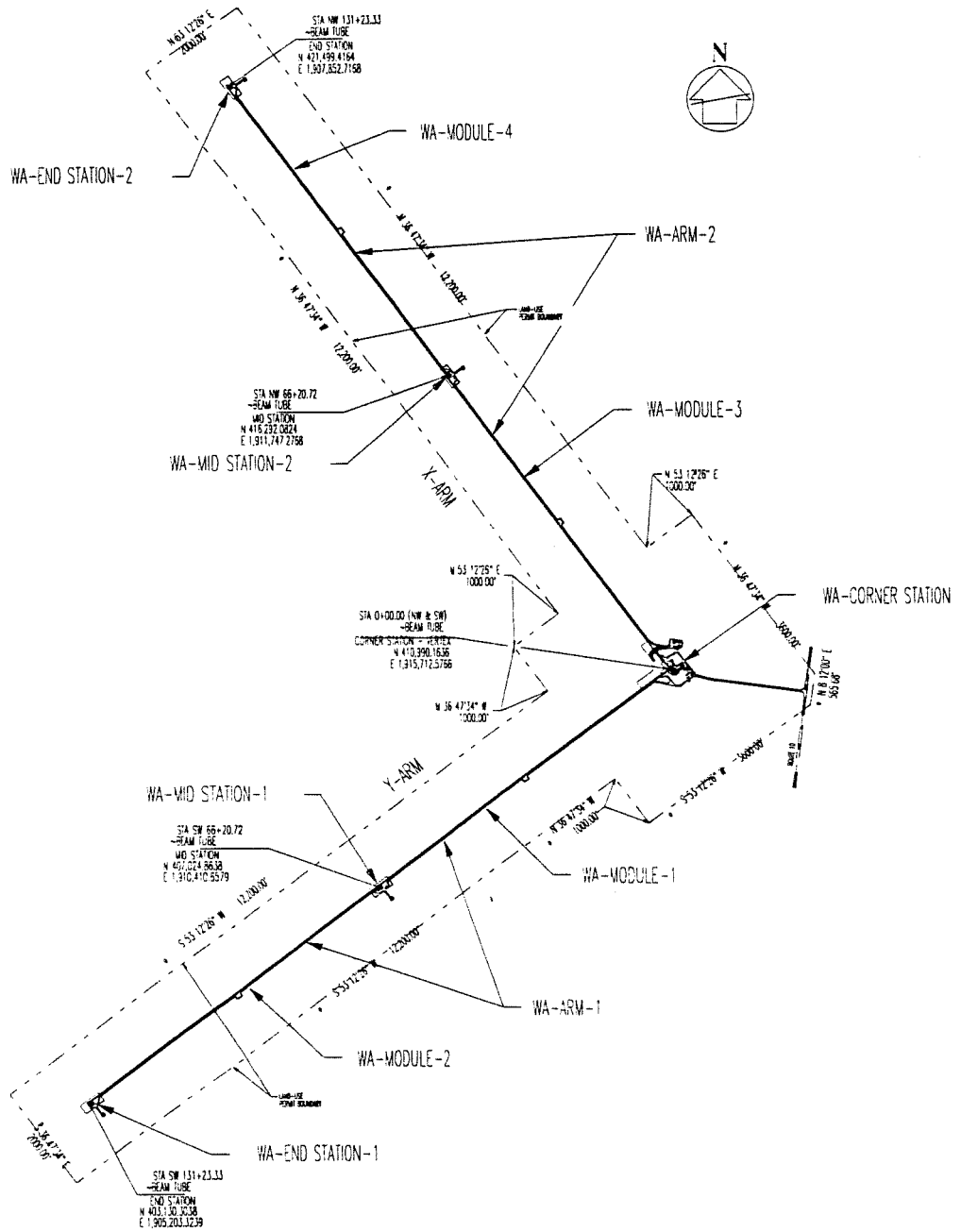

Figure 2.2-1 -- Hanford Property Boundaries (For Reference Only)

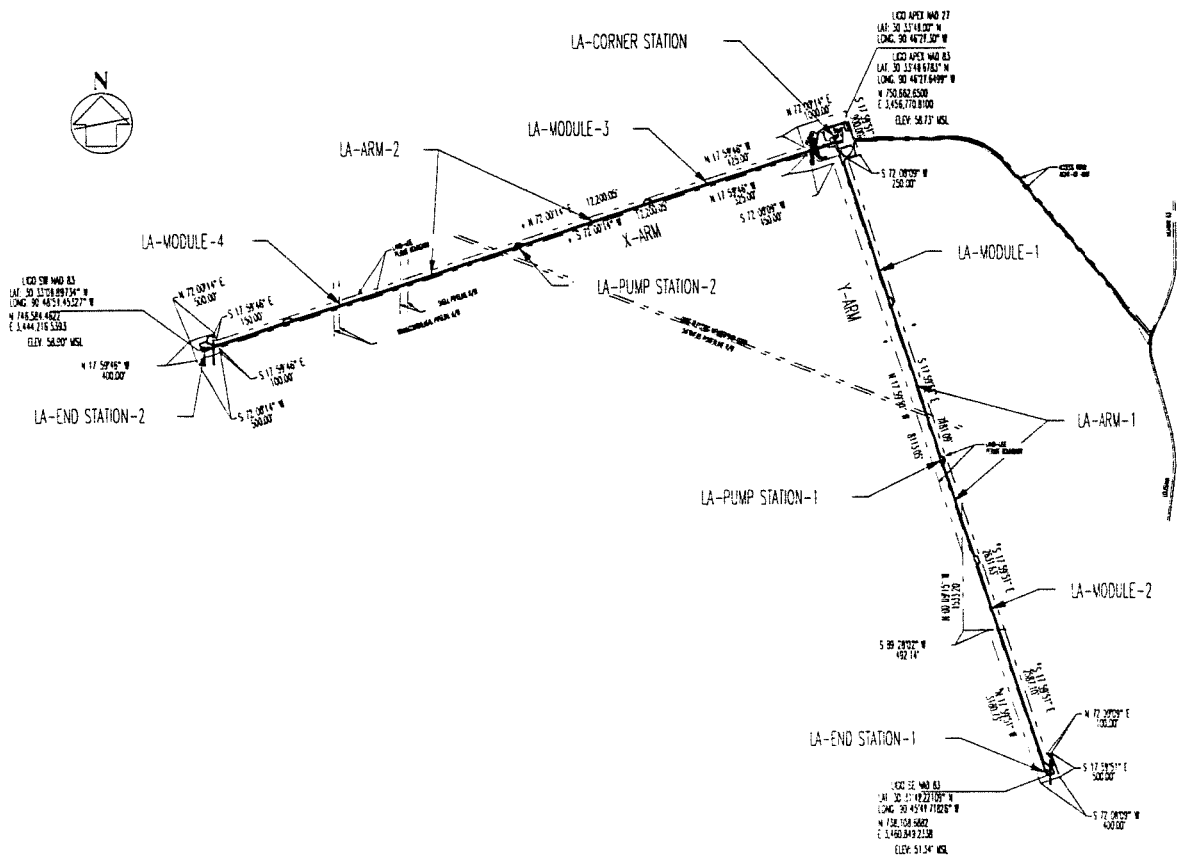

Figure 2.2-2 -- Livingston Property Boundaries (For Reference Only)

2.2.3 Site Preparation and Earthwork

Roads and graded areas shall be laid out to minimize environmental damage. Natural drainage patterns shall be maintained to the maximum extent possible. All Site areas shall be graded away from buildings.

Earthwork slopes and grading shall be in accordance with the recommendations of the geotechnical reports and the following:

- a) Cut slopes shall be 2:1 for Hanford and 2:1 (minimum) for Livingston.
- b) Fill slopes shall be 2:1 for Hanford and 3:1 for Livingston.
- c) Graded area pads shall be sloped 2% preferred minimum for drainage.
- d) At Livingston a minimum freeboard of 2 feet shall be used above the 100-year storm level.
- e) The Beam Tube arm embankments form an "L" shape that shall accommodate the LIGO interferometer arms. The two arms lie along two intersecting lines oriented perpendicularly to one another, and define the plane of the interferometer. The Beam Tube arm embankments shall be flat-graded with respect to this plane (as opposed to the normal grading practice that is relative to the earth's curvature). In order to accommodate local topography and minimize earthwork, the orientation of this plane may be modified by as much as $\pm 0.31 \times 10^{-3}$ radians with respect to a tangent to the Earth's surface (i.e., a theoretical sphere) at the center of the square plane of the Beam Tube arms. The direction of the component of the interferometer plane normal, which lies in the local horizontal plane (at the center of the square), can point in any compass direction.
- f) The Beam Tube embankments shall be designed to minimize settlement to less than 2 inches over the service life (see Section 2.1.2) of the Facility.

2.2.4 Roads, Paving, and Parking

The Site roads shall consist of a main access road to the Facilities and a perimeter road around the Facilities that also tie into the Beam Tube Enclosure (BTE) service roads. The bituminous surface treated BTE service roads along each arm shall provide access to the Beam Tube at 780-foot (237.74-meter) intervals as well as access to the End and Mid Stations. For fire department access, as well as access to the "backside" of the Facilities during construction, a road bridging over at least one Beam Tube near the Corner Station is required.

A frost penetration depth of 24 inches maximum and 12 inches average shall be considered for the Hanford Site for foundation and road design respectively.

2.2.4.1 Roads

The road geometry and cross-sectional design shall be in accordance with the following:

- a) Roads shall be designed to positively drain with a preferred minimum cross slope of 2% whenever possible.
- b) Roads shall have a shoulder width of 3 feet with a cross slope of 4%, wherever possible.
- c) Driveway access to building shall not have shoulders.
- d) Roads shall be two-lane where possible.
- e) Road side slopes shall generally be 2:1 for Hanford and 3:1 for Livingston.
- f) Corner radii shall be no less than 25 feet, where trucks have planned access, the corner radii shall be no less than 35 feet.
- g) Road centerline radius shall be as required for Site vehicles and construction equipment and deliveries (i.e., Beam Tube segments)
- h) Road profile grades shall not exceed 6% whenever possible¹.

2.2.4.2 Paving

Paving design for the Facility roads and parking areas shall be in accordance with the following:

- a) The pavements shall be designed to provide all-weather access.
- b) All access roads shall be flexible pavement unless operational considerations dictate otherwise.
- c) Beam tube service roads shall have a multiple bituminous surface treatment.
- d) Axle loading for roads shall be AASHTO H-20.
- e) California Bearing Ratio (CBR) value for pavement design shall be per geotechnical reports.
- f) Paving shall be as flat and smooth as possible: No speed bumps, manholes, lane divider bumps, grating, etc.
- g) Truck delivery access points to the LVEA/OSB shall be concrete paved.

¹ Bridge overpass shall exceed 9% grade.

2.2.4.3 Parking

Parking spaces shall be provided and designed in accordance with the following:

- a) Parking for the LVEA/OSB Facilities (Corner Station) shall be for:
 - i) Thirty-seven employees, visitors, and maintenance vehicles
 - ii) Two handicapped
- b) Parking for the End Stations shall be for:
 - i) Four employees (including one handicap space)
 - ii) Open areas of sufficient size to park maintenance vehicles.
- c) Parking for the Mid Stations shall be for:
 - i) Four employees (including one handicap space)
 - ii) Open areas of sufficient size to park maintenance vehicles.

2.2.5 Site Drainage

All drainage systems shall be designed to properly drain all surface water that could cause damage to the Facilities, property, and adjoining land. A storm frequency of 25 years shall be used for the design of all drainage structures and in accordance with previously performed hydrology studies.

2.2.5.1 Ditches

Sheet drainage to open ditches shall be used to the maximum extent possible. Ditch side slopes at Livingston shall be no steeper than 3:1 to facilitate mowing and minimize erosion where required. Primary ditch work at Hanford has already been accomplished with ditch slopes at 2:1.

2.2.5.2 Pipes

Pipes or closed conduits shall be used for drainage when open ditches interfere with the intended use of the area.

2.2.5.3 Culverts

Culverts shall be provided under roads or the Beam Tube embankment and whenever the natural drainage pattern is interrupted. Culverts shall comply with the following requirements:

- a) Minimum diameter = 15 inches.
- b) Minimum gradient = 1%.

- c) Alignment shall be in the direction of storm flow and as nearly perpendicular to roads, embankments, or obstructions as possible.
- d) The preferred culvert material shall be reinforced concrete pipe or concrete box sections at Livingston and corrugated metal pipe or reinforced concrete pipe at Hanford.

2.2.6 Utilities

The domestic water supply and the sanitary sewer system for the Corner Station (LVEA/OSB) shall be designed for a total work force of 40 on day shift and 5 each on swing and graveyard shifts. Fifty gallons per person per day shall be used as a basis.

Water and sanitary sewer requirements for the Mid Stations and End Stations shall be designed for 10 personnel (not concurrent with 40 at the Corner Station).

2.2.6.1 Potable Water

- a) Water shall be pumped via underground pipe to a an above ground storage tank at the Corner Station to accommodate Facility requirements and to minimize well pump start/stops.
- b) Based on water quality data from well tests the water may require treatment for potable use.
- c) Potable water shall be distributed from the tank to all Facilities at the Corner Station via an underground system.
- d) The potable water distribution system shall be in accordance with the following:
 - i) Design velocity shall be 5 fps, with a maximum of 10 fps.
 - ii) Minimum earth cover shall be 3 feet.
 - iii) Backflow preventers shall be provided at connections with the possibility of contamination.
 - iv) Water supply shall be designed for the combined peak flow requirement.

2.2.6.2 Firewater

- a) Fire hydrants shall only be placed around the Corner Station as required. Hydrant spacing shall be 300 feet maximum. At branch lines to fire hydrants, gate valves shall be provided. Fire hydrants are not required along the Beam Tubes Enclosures, or at the Mid and End Stations.
- b) Buildings equipped with sprinklers, shall be provided with post indicator valves at each building's sprinkler connection.

- c) Valves for fractional isolation of the firewater system shall be provided if necessary.
- d) The firewater system shall be designed in accordance with Local requirements.

2.2.6.3 Sanitary Sewer

Sanitary sewer pipelines shall be designed in accordance with the following:

- a) The minimum line size shall be 4 inches diameter for gravity flow.
- b) Design velocity shall be a minimum of 2 fps flowing at half depth or 3 fps when cleaning is difficult.
- c) Sewers shall have straight runs between manholes (if manholes are needed).
- d) Clean-outs shall be used for changes in direction of minor sewer laterals and building connections.
- e) To help eliminate vibration sources, man-holes shall not be located in road or parking lot surfaces or other traffic areas.

2.2.7 Wastewater Treatment Facilities

Federal, State, and Local codes regarding collection, treatment, and discharge of sanitary wastes shall be met. Sewage collected from the LIGO Facilities at Hanford shall be treated by a septic tank system with effluent disposal through a leach field system. Sewage collected from the LIGO Facilities at Livingston shall be processed through a package tertiary wastewater treatment plant with effluent discharge to natural waterways. Sludge from both cases shall be picked up by Local Contractors.

2.2.8 Miscellaneous Sitework

2.2.8.1 Solid Waste Disposal

Solid waste (trash) shall be collected by a locally contracted solid waste disposal firm from a Facility location outside the 200-foot non-critical traffic exclusion zone.

2.2.8.2 Pipeline Crossings

There are two right-of-ways for oil company pipelines crossing the Livingston Site. These pipelines shall be protected in a manner acceptable to both oil companies and LIGO.

2.3 Structural

2.3.1 General Structural Requirements

2.3.1.1 Steel Design and Construction

Steel structures and components shall be designed and constructed in accordance with the AISC Specification for Structural Steel Buildings, Allowable Stress Design and Plastic Design, and the AISC Code of Standard Practice for Steel Buildings and Bridges. All structural welding shall be in accordance with AWS D1.1, A2.4, and A3.0.

2.3.1.2 Concrete Design and Construction

Concrete structures and components shall be designed and constructed in accordance with ACI 318. Minimum tolerances for concrete construction and materials shall be per ACI 117, "Standard Specification for Tolerances for Concrete Structures and Materials", unless noted otherwise in this document.

2.3.1.3 Concrete Reinforcing Steel

Steel reinforcement shall conform to the requirements of ASTM A615, Grade 60. Detailing, fabrication, and placement shall be in accordance with CRSI-1.

2.3.1.4 Masonry Design and Construction

Masonry structures and components shall be designed and constructed in accordance with ACI 530.

2.3.1.5 Inspection Requirements

Inspection requirements, along with acceptance criteria, for steel and concrete structures and components shall be clearly specified by the A-E in the drawings and specifications. Inspections shall be in accordance with UBC.

2.3.2 Loading Conditions

Structural systems and components shall meet or exceed requirements of the UBC code for both the Hanford and Livingston Sites. The buildings at both Sites shall be designed for the of most severe load conditions and/or combinations resulting from seismic and/or wind loads.

2.3.2.1 Minimum Floor Live Load

The minimum floor live load shall be as follows:

- a) 250 psf for storage and receiving areas
- b) 100 psf for control room, shops and LVEA/VEA areas
- c) 50 psf for office area

2.3.2.2 Seismic Load

- a) Seismic loads shall be applied and the structure analyzed using one of the methods described in the UBC for both the Hanford and Livingston Sites.
- b) At the Hanford Site, the structure is located in Seismic Zone 2B and at the Livingston Sites, the structure is located in Seismic Zone 0. Zone 2B loads shall be used as the generic seismic loading for both Sites.

2.3.2.3 Wind Loads

Wind loads, for the Hanford Site, shall be determined in accordance with UBC using a design wind speed of 70 mph, exposure C and importance factor $I=1.0$. Wind loads, for the Livingston Site shall be determined using a design wind speed of 100 mph, exposure C, and importance factor $I=1.0$. 100 mph wind speed. I

The design of both sites shall incorporate the more restrictive criteria, 100 mph wind speed, exposure C, and importance factor $I=1.0$.

2.3.2.4 Forklift Loads

Design shall allow a 10,000-pound capacity forklift to operate anywhere within the following areas of the Corner, Mid, and End Stations.

- Inspection/Shipping/Receiving
- Cleaning Area
- LVEA/VEA
- Active Storage Area
- Long-Term Storage Area

2.3.2.5 Volcanic Ash Loads

The Hanford Site structures shall be designed for a volcanic ash load of 2 psf (equivalent to approximately 3/8" standing water).

2.3.2.6 Load Combinations

Load combinations shall be in accordance with the UBC.

2.3.2.7 Crane Loads

The Corner, Mid, and End Stations shall be designed for appropriate capacity crane loads. See Section 2.5.6 and 3.5.6 for configuration of bridge cranes and monorails.

2.3.2.8 Serviceability Requirements

Deflections due to live, wind, or seismic load shall be limited as follows:

- a) Maximum allowable live load deflection shall be $L/240$, except for elements supporting plaster ceilings in which case the maximum deflection shall be limited to $L/360$.
- b) Seismic or wind induced lateral drift shall not exceed the requirements of 0.005 times the story height.

2.3.2.9 Beam Tube Foundation and Enclosure Requirements

- a) Initial Beam Tube slab "straight line" variance of finish floor shall be limited to ± 1 inch for the entire length of all Beam Tube arms (distance = 4 km).
- b) Initial slab "straight line" variance of finish floor shall be limited to $\pm 1/4$ inch in 10 feet.
- c) The foundation at the Beam Tube support shall be constructed to a tolerance of $\pm 1/2$ inch between the successive supports (about 65 ft).
- d) The long-term differential settlement shall be limited to ± 2 inches with reference to the Beam Tube axis.
- e) Beam Tube terminus valves where atmospheric pressure can exist on one side only, shall be supported from a foundation designed to react to the combination of all applied fixed support loads.
- f) BTE, and doors at service entrances and emergency egresses to the BTE, shall be capable of stopping penetration of a stray bullet per the requirements identified in Table 2.3-1.
- g) Longitudinal placement tolerance of the Service Entrances shall be ± 4 inches.

Item	Property
Caliber:	308
Weight:	180 Grains
Velocity at Impact:	2900 Feet Per Second
Energy at Impact:	2800 Foot-Pounds
Material:	Lead Core, Fully Jacketed with Copper

Table 2.3-1 -- BTE Projectile Data

2.4 Architectural

2.4.1 The LIGO Facility Corner Station shall contain a "Clean Environment" (See Section 2.4.9) for the LVEA. This clean environment is not required to meet Federal Standard 209 requirements, but is being provided to help ensure equipment cleanliness. The Corner Station also contains the OSB for maintenance and administrative functions. Other LIGO facilities are the Beam Tube Enclosures, Mid and End Stations, Maintenance Building, and utility components that provide conditioned air, power, and water/waste treatment. These structures shall be located at both Hanford, Washington, and Livingston, Louisiana. The Mid Stations at Livingston however, shall be simple Mid-Point Pump Stations that house a gate valve, ion pumps, and associated electronic equipment.

The LVEA shall be designed to house high-precision, sensitive interferometer components (provided by Others). The interferometers require a relatively clean and controlled environment with a minimum of disturbance from acoustic noise, ground vibrations, electromagnetic interference, and other localized disturbances. Each interferometer uses one or more high-power lasers which shall be located within this area. Many of the interferometer components are contained within a high vacuum envelope generally referred to as the "vacuum equipment."

The vacuum equipment (provided by Others) is composed of a network of vacuum chambers, which house sensitive interferometer components, and interconnecting beam-tubes which facilitate transmission of laser beams between the chambers. High-vacuum gate valves are provided between operation-critical sections of the interconnecting tubing to isolate different portions of the vacuum system for diagnostics, maintenance, or upgrades while other portions remain operable.

Relocatable vacuum pumps (provided by Others) are deployed where needed by overhead cranes, air pallets, or carts, and coupled locally to valved ports for pump-down. Stationary high-vacuum ion pumps are attached to individual chambers. Liquid nitrogen (LN₂) pumps at the ends of the adjacent Beam Tube modules provide additional pumping capacity.

The vent/purge subsystem (provided by Others) generates and distributes filtered, dry air for backfilling chambers when they are to be opened. This subsystem also provides internal filtered air showers to maintain cleanliness while working inside the chambers.

A bake-out subsystem (provided by Others), composed of relocatable heaters, insulation, and power connections, allows vacuum baking of individual valved-off sections of the vacuum equipment. This permits removal of contaminants and reduction of out-gassing when required.

In addition to lasers and vacuum equipment, this area contains electronics racks, cable trays, and cabling for the interferometers; all provided by Others.

- a) The LVEA is not classified as a cleanroom, however the design intent is to achieve a "Clean Environment" (See Section 2.4.9).
- b) The LVEA shall be accessible by both Staff and equipment via the Cleaning Area.
- c) The LVEA ceilings shall have sufficient height to accommodate overhead crane systems to facilitate movement of equipment components for repair, maintenance, and replacement. Ceilings shall be composed of 2-foot by 4-foot lay-in panels with a smooth non-flaking washable surface and finish.
- d) LVEA walls shall have an 8-foot high painted metal wainscot made of durable, cleanable surface of an inorganic and non-gassing finish or coating to aid the maintenance of cleanliness. LVEA walls shall be painted above wainscot with a semi gloss non VOC latex and in accordance with Section 2.4.7.
- e) The finish floor elevation of the LVEA shall be nominally 2 feet 7 inches lower than the finish floor elevation of the adjacent BTEs. Floors in the LVEA shall be a sealed concrete with smooth, non-flaking, washable surface finish, and compatible with Class 50,000 material properties.

2.4.2 Operations Support Building

2.4.2.1 Facility Control Room

The Facility Control Room is the operational center of the Facility. It provides an office quality environment for the operations crew. The Facility Control Room equipment consists mainly of desktop computing workstations and rack-mounted electronics. This room also provides space for the Facility Monitoring and Control System (FMCS) panels, Fire Alarm and Control Panels (FACP), personnel access control, and building surveillance via a low-light level closed-circuit television system.

- a) The Facility Control Room shall have an area of approximately 1245 square feet.
- b) The floor shall be a 24 inch raised access floor system with anti-static carpet (per Section 2.4.7.1).

- c) Walls shall be painted gypsum board
- d) Ceiling height shall be 12 feet with suspended acoustic tile system.
- e) The Facility Control Room shall be provided with a fire detection and suppression system that shall use a gaseous suppression compatible with the occupancy and type of equipment installed.

2.4.2.2 Computer Users Room

The Computer Users Room is similar to the Control Room. The space shall provide an office quality environment for data analysis, software development, and communications. The Computer Users Room equipment consists mainly of desktop computing workstations, printers, plotters, scanners, and reference areas.

- a) The Computer Users Room shall have an area of approximately 477 square feet and shall be accessible to the Control Room.
- b) The floors shall be 24 inch raised access floor system with anti-static carpet as described in Section 2.4.7.1.
- c) Walls shall be painted gypsum board.
- d) Ceiling height shall be 10 feet with suspended acoustical tile system.

2.4.2.3 Tape and Computer Mass Storage Room

The Tape and Computer Mass Storage Room house rack-mounted computing equipment, mass storage units, and peripherals (disk and tape drives, etc.), as well as storage cabinets for magnetic tapes. This area shall have access flooring to allow easy cabling. The equipment for these areas consists mainly of desktop computing workstations for the diagnostics portion of the operation.

- a) The Tape and Computer Mass Storage Room shall have an area of approximately 604 square feet, and is accessible to the Control Room.
- b) Walls shall be painted gypsum board.
- c) Floor shall be a 24 inch raised access floor system with anti-static carpet (per Section 2.4.7.1).
- d) Ceiling height shall be 11 feet with suspended acoustic tile system.

2.4.2.4 Staff Offices, Lobby, and Visitor Accommodations

This area includes Staff offices, Administrative Assistant, Storage, and common areas, such as Multi-Use Room, Rest Rooms, Kitchen/Break Room, and Conference Room suitable for the permanent and visiting Staff/Scientists. In addition, this area provides space for general visitors. The Facility entrance for employees, users, and visitors shall be through Vestibule and Multi-Use Room, and is controlled from an Administration Assistant area. The

conference room, all workspaces, and all offices shall have provisions for computer networking.

2.4.2.5 Optics Lab

This lab is designated to provide support for inspections, cleaning, testing, and storing of optics required for operating the experiment. This shall also be the location of an optics technician.

- a) The Optics Lab shall have an area of approximately 990 square feet and adjacent to the Vacuum Prep and Assembly Lab, and the Cleaning Area.
- b) Materials and finishes shall be durable and cleanable, consistent with clean environment construction (See Section 2.4.9).
- c) The Lab shall be a clean environment (similar to the LVEA -- Section 2.4.9) for assembly of objects up to 1 meter cubed and weighing up to several hundred kilograms.

2.4.2.6 Vacuum Prep and Assembly Area

This Lab provides for the assembly and disassembly of vacuum components and subsystems for cleaning with solvents and detergents, and bake-out and out-gassing certification of new components. This shall also be the location for mechanical engineer and technician functions at workstations and workbenches.

- a) The lab shall be a clean environment (similar to the LVEA -- Section 2.4.9) for assembly of objects up to 1 meter cubed and weighing up to several hundred kilograms.
- b) This area shall be approximately 610 square feet, adjacent to the Optics Lab, and accessible to the Inspection and Cleaning Areas.
- c) Materials and finishes shall be durable and cleanable consistent with clean environment construction (See Section 2.4.9).

2.4.2.7 Electronics Test and Maintenance

This shop provides the space to repair and assemble electronics and cabling, and the space to perform measuring, calibration, and troubleshooting of the electronic components of the lasers and interferometers (both new and existing). Other activities include the design of new electronics necessary to support testing and experiment activities. This shall also be the location of electronics engineer and technician functions.

- a) The Electronics Test and Maintenance Shop shall have an area of approximately 1150 square feet.
- b) Walls shall be painted gypsum board.

- c) Ceiling height shall be 11 feet with a suspended acoustic tile system.
- d) Floor shall be a 24 inch raised access floor system

2.4.2.8 Mechanical Shop

This shop provides the space to check, maintain, and repair interferometer and Facility equipment. The mechanical shop contains small-scale machining and welding equipment (provided by Others) such as drill presses and lathe/milling machines, for maintaining or modifying interferometer and vacuum equipment components.

- a) The Mechanical Shop shall have an area of approximately 640 square feet.
- b) Walls shall be painted gypsum board.
- c) Ceiling height shall be 11 feet with a suspended acoustic tile system.

2.4.2.9 Inspection/Receiving/Shipping

Equipment that arrives at the LIGO Facility loading area shall be processed through this area in a manner that helps ensure the integrity of the clean environments. Packages that arrive at the loading area shall be cleaned externally before being moved into the Inspection/Receiving and Shipping Area. There, they are unpacked from the outer shipping container and moved to the Cleaning Area.

- a) Inspection/Receiving/Shipping shall have an area of approximately 540 square feet in size and accessible to the Cleaning Area and the loading area.
- b) The ceiling height shall be 20 feet (minimum) with a suspended ceiling system.
- c) An overhead equipment door shall be provided from outside the LIGO Facilities for access and deliveries via the loading area. See Section 2.4.8.2 for additional information.
- d) Materials and finishes shall be durable and cleanable. Walls shall have a hard-surface, 8 feet high painted metal wainscot.
- e) Movement of large objects from the Loading Dock or Cleaning Area, to Inspection/Receiving/Shipping shall be by a ground-based system (by Others).
- f) Ceiling superstructure shall have provisions for future 5-ton monorail at the centerline of the access corridor.

2.4.2.10 Cleaning Area

Equipment destined for the LVEA is moved from the Inspection/Receiving/Shipping Area to the Cleaning Area. Here the inner packaging is removed and the contents are inspected and

cleaned. Doors connecting through this area shall be opened one at a time to prevent outside dust or particulate contamination riding on packaging from reaching the LVEA.

- a) The Cleaning Area shall have an area of approximately 551 square feet in size and accessible to the LVEA and the Inspection/Receiving/Shipping Area.
- b) The ceiling height shall be 20 feet (minimum) with a suspended ceiling system.
- c) An overhead equipment door shall be provided to allow direct access to the LVEA from the Cleaning Area. See Section 2.4.8.2 for additional information.
- d) Materials and finishes shall be durable and cleanable. Walls shall have a hard-surface, 8'-0" high painted metal wainscot.
- e) Movement of large objects from the Loading Dock to the Cleaning Area shall be by a ground-based system.
- f) Ceiling superstructure shall have provisions for future 5-ton monorail at the centerline of the access corridor.

2.4.2.11 Active and Long-Term Storage

These areas are used to store parts and components integral to the common maintenance of Facility and equipment.

- a) The Active Storage shall have an area of approximately 552 square feet.
- b) Long Term Storage shall be approximately 588 square feet.
- c) Walls shall be painted gypsum board.
- d) Ceiling height shall be 20 feet with a suspended acoustic tile system.

2.4.2.12 Change Room

All personnel enter the LVEA via this space. This space contain small lockers and benches to facilitate the gowning-up process prior to entering the LVEA.

- a) The Change Room shall accommodate 5 people at one time, shall be approximately 196 square feet, and shall be accessible to the LVEA via the Cleaning Area. The door exiting the Cleaning Area, towards the LVEA, shall be controlled by the Facility Operator located in the Facility Control Room.
- b) The room shall be equipped with storage lockers and portable benches. Lockers shall be used for clean smocks, booties, gloves, and other necessities for clean environment entry and work. Disposal bins shall also be provided.
- c) Material and finish shall be consistent with clean environment construction (See Section 2.4.9).

- d) The ceiling height shall be 10 feet (8 feet minimum).

2.4.2.13 Shower and Toilet Room

A unisex shower and toilet room is located adjacent to the office and control areas of the OSB. The room accommodates one person at a time, is approximately 133 square feet, and is equipped with storage lockers and portable benches.

- a) The ceiling height shall be 8'-6" with a painted gypsum board finish
- b) The floors shall be ceramic tile.
- c) Walls shall be full height ceramic tile at plumbing walls and painted gypsum board at other walls.

2.4.3 Mechanical Room

This building provides space for equipment such as HVAC, and other mechanical and electrical equipment associated with the Facility operations. It also provides space for equipment provided by the Vacuum Equipment (VE) Contractor.

The Mechanical/Utility Room shall be vibrationally isolated from the LVEA and shall be serviced by a remotely located chiller plant to minimize vibration transfer to the LVEA. Air handling units shall be designed for minimum induced vibration and acoustic noise.

2.4.4 Chiller Plant at Corner Station

The Corner, Mid, and End Station chilled-water plants provide chilled water to the HVAC systems, and, at the Corner Station, the closed-loop cooling systems for the lasers. Cooling for the lasers is provided by individual closed-loop water cooling systems (provided by Others) with heat exchangers that are coupled to a Facility chilled-water line. The chilled-water plant shall be located to minimize transmission of vibration and acoustics to the LVEA.

2.4.5 Mid and End Station Facilities

Facility areas shall follow height and material criteria for like spaces of the Corner Station.

The buildings for the End Stations at both Sites and the Mid Stations at the Washington Site shall be of similar design, but differ in their vacuum equipment layout. The functional requirements and designs shall be similar to those of the Corner Stations, except that the vacuum equipment in these Stations is much simpler and there is no need for personnel offices. These Stations include a VEA, Support Services Area, Change Room, Cleaning Area, Inspection/Shipping/Receiving Area, Experiment Equipment Area, Toilet, Janitors Closet, Mechanical Room, Vacuum Support Equipment, and remote chilled-water plant.

Access to the buildings and the VEA shall be controlled and monitored from the Facility Control Room in the Corner Station by the Facility operator.

All finish floor elevation of the Mid and End Stations shall be nominally 2 feet 7 inches below the finish floor elevation of the adjacent BTE. Finish floor elevation of the Mid-Point Pump Stations at Livingston shall be at the same as the finish floor elevation of the adjacent BTE.

The design and construction approaches of VEAs shall be similar to those used for the LVEA in the Corner Station. These areas shall contain vacuum chambers, pumps, and valves (provided by Others) which shall be serviced by an overhead bridge crane. It also encloses electronics racks (provided by Others) and associated cabling for control and data acquisition.

The Mid and End Stations contain areas for unpacking, inspection, and cleaning of interferometer and vacuum equipment. They also shall include a small work area for maintenance and servicing interferometer components and optics. If these items need a clean working environment, then they shall be bagged and moved to the Corner Station OSB.

An attached utility room, with separate foundation for vibration control, houses mechanical (i.e., HVAC air handler units, etc.), and electrical equipment (i.e., motor control centers, etc.). Adjacent to the utility room is the Vacuum Support Equipment room which houses the support equipment for the vacuum equipment system.

Chillers shall be located at a separate and remote yard. This yard shall be separate from the Mid and End Stations and is of similar design to the Corner Station yard. Chilled water shall be required for the HVAC system only since there are no high-power lasers in these Stations.

2.4.6 Beam Tube Enclosures

The BTE at each Site are made up of four similar 2-kilometer long modules. The BTE protects the high-vacuum Beam Tube walls from vibration induced by wind. In addition, it protects the tube walls from mechanical impacts which could release bursts of gas into the interferometer beams, thereby contributing noise. The enclosure provides a moderate amount of thermal stability for the Beam Tubes, reducing the variation in residual gas pressure. It also provides protection against damage to the Beam Tubes from stray bullets. A potential configuration is shown in the Figure 2.4-1.

The foundation at the Beam Tube support shall be constructed to a vertical tolerance of $\pm 1/2$ inch between the successive supports (about 65 feet apart). Beam tube supports shall be attached to the foundation with anchor bolts (all provided by Others). The foundation shall be designed to minimize settlement and to take static- and vacuum-related loading of the Beam Tubes and their various components. See Section 2.3.2.9 for additional criteria on this Facility component.

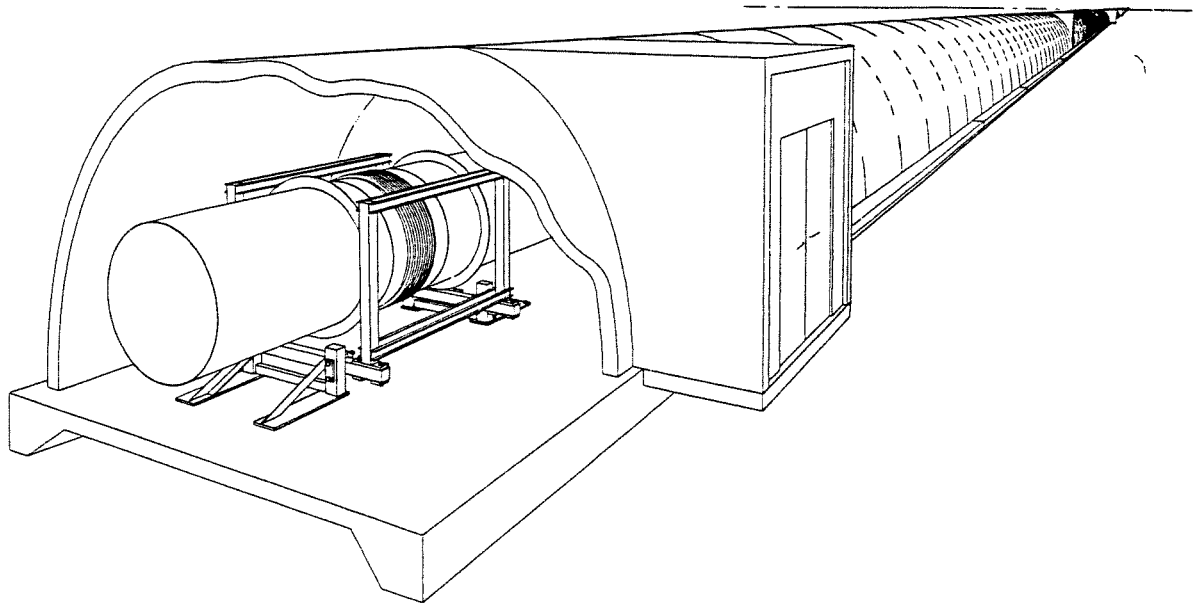

Figure 2.4-1 -- Cut-Away of Beam Tube Enclosure

The BTEs shall not be occupied spaces; however, access is required for occasional maintenance and scientific activities. The enclosure configuration shall provide adequate room for access to repair leaks, adjust alignment of the Beam Tube, and conduct occasional Beam Tube bake-outs. Entries to the BTE shall be required at 780-foot intervals for installing and servicing the future vacuum pumps. The enclosure shall provide space for internal distribution of signal and power cables. Minimal permanent lighting shall be required. Utility outlets shall be provided at the 780-foot entries.

- a) Service access to the enclosure shall be located at every 780-feet. These Service Entrances shall be placed with a longitudinal tolerance of ± 4 inches.
- b) Emergency egress from the enclosure shall be at a maximum of every 500-feet (152-m) as required by UBC Section 1003.4, Travel Distance for a 1-Hour Fire Rated Structure.
- c) The enclosure shall not be equipped with permanent fans. LIGO Operations shall have to provide proper temporary ventilation to meet health and safety requirements prior to human access.
- d) The enclosure structure shall be water-tight, joints are to be sealed to prevent intrusion of water, dust, vermin, and insects. The enclosure shall also be resistant to penetration of bullets (see Section 2.3.2.9).

2.4.7 Finishes

- a) All architectural finishes shall be compatible with the internal and external environments described in Sections 2.1.8, 2.5.2.1, and 2.5.2.2.
- b) All paints and coatings shall conform to the local Air Pollution Control District requirements in the States of Washington and Louisiana.

2.4.7.1 Floor Finishes

- a) LVEA floors shall have a durable surface to withstand occasional forklift traffic, and meet the intent of Class 50,000 floor surfaces.
- b) Other exposed interior concrete floor surfaces shall have a smooth, steel trowelled finish with a surface hardener.
- c) Facility Control Room, Computer Users Room, Tape and Computer Mass Storage Room, and Computer Users Room shall have access flooring with anti-static carpet. Electronics Test and Maintenance shall have access flooring without carpet.
- d) Offices, conference room, and receptionist areas shall have carpet.
- e) Main entrance Multi-Purpose Room shall have terrazzo paving.
- f) All other interior spaces shall have resilient floor tile except the toilet facilities which shall have ceramic tile.
- g) Exterior concrete floor surfaces shall have a broom finish.
- h) Special finishes shall be designated for the main entry and patio at the OSB.
- i) Joint filler and sealer materials resistant to the effects of the induced environment as required shall be used.

2.4.7.2 Walls

- a) Exterior walls shall be composed of proven architectural materials and shall be insulated, weather-resistant materials providing an air- and water-tight, maintenance-free enclosure.
- b) Exterior walls shall be durable, minimal-maintenance materials with an expected minimum life expectancy of 30 years.
- c) Interior walls for the "clean environments" shall be smooth, non-shedding, and compatible with each room's intended use and classification (if any).
- d) Interior walls for toilet areas shall be water-resistant (WR) gypsum board with full height ceramic tile at plumbing walls.

2.4.7.3 Ceiling Finishes

- a) Ceilings shall be suspended acoustical tile in general areas such as offices, Conference Room, Computer Rooms, Storage Room, Shop Areas, and Lab Areas.
- b) Suspended ceilings shall be used in clean areas to be compatible with their respective area classification (if any). Materials shall be selected as required to meet acoustic requirements as described in Section 2.8, Acoustics.

- c) Other areas, such as Toilet facilities, Locker Rooms, and Janitor's Rooms, shall be suspended hard-surfaced ceilings.
- d) Exposed ceiling/roof structure shall be used in other areas such as mechanical rooms, and utility spaces.
- e) WR gypsum board shall not be used for ceiling applications.

2.4.7.4 Painting -- General

- a) All exposed and untreated materials requiring protection shall be field painted.
- b) Surfaces shall be finished, cleaned, and dry prior to receiving painting.
- c) Materials shall be primed with one coat, 0.5 mils dry film thickness, of paint primer.
- d) Materials shall receive one intermediate coat and one finish coat of paint. The intermediate coat shall be a different color than the finish coat. Each coat shall be a minimum of 3 mils dry film thickness.
- e) Surfaces not to be painted:
 - i) Concrete floors
 - ii) Glass
 - iii) Masonry, unless specified
 - iv) Precast concrete, unless specified
 - v) Factory-finished items
 - vi) Items specified in construction documents as surfaces not to be painted
- f) All colors shall be selected in accordance with the color palette as established by the architect and the LIGO Technical Representative. The finish coat of all painted interior clean environment surfaces shall be white.

2.4.7.5 Shop and Field Painting (Metals)

- a) All exposed ferrous and nonferrous metal to be installed and used for flashing, railings, louvers, doors and frames (including copper and galvanized surfaces) shall be shop or field painted. Ferrous metal surfaces preparation shall be in accordance with Steel Structures Painting Council (SSPC) specifications.
- b) Blast cleaning shall be in accordance with SSPC-SP-10. In areas where sand blasting is not allowed, surfaces shall be prepared in accordance with SSPC-SP-2 and/or SSPC-SP-3.
- c) Ferrous metals shall be painted with one coat, 3 mils dry film thickness.
- d) Nonferrous metals shall be prime-coated with 0.5 mils dry film thickness of primer.

- e) All ferrous and nonferrous metals shall receive one intermediate coat and one finish coat. The intermediate coat shall be a different color than the finish coat. Each coat shall be a minimum of 3 mils dry film thickness.
- f) Surfaces not to be painted:
 - i) Air terminals (Lightning Protection System)
 - ii) Ladder rungs
 - iii) Chain rails and hoist points
 - iv) Bridge crane wheel/wire rope/rail interfacing surfaces
 - v) Lightning connectors/down cable isolation blocks
 - vi) Stainless steel, brass, and bronze
 - vii) Top surface of aluminum floor plates
 - viii) Aluminum handrails
 - ix) Handrail post sockets
 - x) Wear surfaces of hinges or mechanisms
 - xi) Winch cable drums
 - xii) Factory finished items
- g) All colors shall be compatible with the established color palette as stated in the Section for Painting - General.

2.4.7.6 Caulk and Sealant

Caulk/tape/sealant used in each type of clean environment shall be compatible with the classification of the clean environment.

2.4.8 Doors -- General

- a) The clean environment door opening mechanisms design shall minimize the amount of contaminants generated by their operation.
- b) All doors in the clean environment perimeter walls shall be equipped with weather-strips and seals in order to minimize air leakage/loss from clean environments and contamination.

2.4.8.1 Equipment Doors

- a) All equipment doors shall be 6 feet wide by 9 feet high, 1-3/4 inch thick, insulated hollow metal doors.
- b) All control area rooms, electronics shop, long-term storage, and shipping and receiving areas shall have "equipment size" doors.

2.4.8.2 Large Access Doors

- a) All large access doors shall be metal unless otherwise noted.
- b) All large access doors shall be power actuated (with provisions for manual override), insulated at exterior exposures, and shall provide a finished clear opening 12 feet wide by 16 feet high to the OSB shipping/receiving area, 8 feet wide by 12 feet high inside the OSB or between the OSB and LVEA, and 14 feet by 30 feet high from the LVEA to the outside. See Section 2.6.11 for door control requirements.
- c) The large access door between the Cleaning Area and LVEA shall be 90 minute motorized sliding door to create a 2-hour fire separation.
- d) All large access doors shall be installed per NFPA 80.
- e) In closed position, all edges of large access doors shall be sealed to prevent infiltration of outside air, insects, animals, and dust and to prevent pressure loss from interior spaces.

2.4.8.3 Personnel Doors

- a) Personnel doors shall be 3 feet wide by 7 feet high insulated hollow metal doors.
- b) All doors shall be 1-3/4 inches thick.
- c) UBC, SBC, and NFPA requirements shall be applied when fire-rated doors are required.
- d) Door hardware shall comply with Industry Codes and Standards.
- e) When necessary, specialized door hardware shall include automated entry control and intrusion detection devices, door-mounted combination locks, dead bolts and padlocks, lever-type hardware, exit hardware, electric strikes/latches, electric power transfers, heavy-duty door closers meeting vibration requirements, lock cylinders, sound or weather seals, automatic door bottoms, hinges with nonremovable pins, and associated equipment.

2.4.8.4 Office Doors

- a) Doors at the OSB shall be 3 feet wide by 7 feet high wood veneer doors with metal frames.
- b) All doors shall be 1-3/4 inches thick.
- c) Door hardware shall comply with Industry Codes and Standards.
- d) Doors at one-hour exit corridors shall be 20-minute fire-rated doors with Code compliant exit hardware.

2.4.8.5 Thresholds

Thresholds shall be a maximum of 1/2 inch above finish floor.

2.4.9 "Clean Environment" Interior Design

To assist in maintaining a clean environment, interior surfaces of these areas shall be designed to the following criteria. This is required in the LVEA, VEA, Optics Lab, and Vacuum Preparation and Assembly Lab; however, these areas are not classified as "cleanrooms" by Federal Standard 209.

- a) Minimize horizontal ledges and surfaces
- b) Fully enclose all structural shapes
- c) Line all necessary pockets and recesses with cleanable shapes
- d) Cove all inside corners
- e) Provide seams that shall not retain soil or dust
- f) Provide smooth, non-flaking and washable surfaces and finishes
- g) Provide closed chases for pipes and conduits where possible
- h) Provide access for cleaning all surfaces
- i) Provide flush/surface-mounted lighting fixtures

2.4.10 Roofs and Gutters

Roofing design for structures shall meet the requirements of UBC and SBC. Roof penetrations shall be eliminated if at all possible. Rain-water shall run off directly over the roof edge.

2.4.11 Life Safety

The LIGO Project shall be designed in accordance with the UBC for the Washington Facility, and the NFPA 101 Life Safety Code for the Louisiana Facility. These codes shall be followed to provide emergency exits and exit access ways as applicable for all Facilities including the BTEs.

2.4.12 Energy Conservation

"U" values for roofs and exterior walls shall be determined in accordance with the governing state codes for energy conservation, or with ASHRAE design guidelines.

2.5 Mechanical

2.5.1 General Mechanical Requirements

2.5.1.1 Mechanical System and Component Identification

Mechanical system and component identification shall comply with requirements stated in ANSI A13.1 for lettering, colors, band-widths, marker locations, and viewing angles.

2.5.1.2 Wind Loads

All exposed mechanical equipment and plumbing piping systems shall be designed to withstand wind loads as specified in ASCE 7-88.

- a) For noncritical systems, the Importance Factor equals unity.
- b) For critical systems, the Importance Factor equals 1.1.

2.5.1.3 Corrosion Control

Corrosion control measures shall include cathodic protection systems, copper-finned coils and tubes, as well as the use of protective coatings.

- a) The use of protective coatings shall be in accordance with NACE-RP-02-75.
- b) Protection shall be provided against corrosion caused by galvanic action due to physical contact of dissimilar metals.

2.5.1.4 Factory Paint

- a) Unless otherwise specified, all ferrous and nonferrous metal to be installed inside the Facility shall have surfaces prepared in accordance with SSPC-SP-10 and shop-primed with two-part, organic zinc-rich epoxy for ferrous metals, or organic zinc-rich chromate primer for nonferrous metals.
- b) Field painting shall be in accordance with Section 2.4.7.5.

2.5.1.5 Vibration Control

- a) All major rotating equipment shall be statically and dynamically balanced as a complete assembly.
- b) Maximum displacement amplitude of any major piece of rotating equipment shall be significantly less than 2 mils peak-to-peak, at typical steady state operating speeds of 30 Hz or 60 Hz, with 3 Hz isolation systems if specified.

2.5.1.6 Motors

- a) All motors shall be high-efficiency type, non-overloading in accordance with Section 2.6.3. The HVAC fan motors shall be induction -type motors located within a single mechanical room. The fans shall have adjustable pitch blades to control air flow-rate. The HVAC fans and motors shall be skid-mounted to permit each fan and motor pair to be vibration isolated from the mechanical room foundation.

2.5.1.7 Safety Requirements

Provide the following safety requirements:

- a) Belts, pulleys, chains, gears, protruding set screws, keys and other rotating parts shall be fully enclosed or properly guarded in accordance with OSHA 29 CFR 1910.219.
- b) High-temperature equipment and piping so located as to endanger personnel or create a fire hazard shall be properly guarded or covered with insulation.
- c) Where required for safe operation and maintenance of equipment, such items as catwalks, platforms, ladders, and guard rails shall be provided.

2.5.1.8 Redundancy

- a) Redundancy shall be provided by including a standby unit for all critical areas that are served by only one air-handling system.
- b) All redundant equipment shall be provided with automatic start capability and manual override.
- c) Provisions shall be made for future addition of additional water chiller at the Corner Station

2.5.2 Heating, Ventilating, and Air Conditioning Systems

The HVAC systems shall be designed for optimum energy conservation and operational cost with minimum vibration transmission to the LVEA/VEAs. Centralized automatic control and system surveillance shall be provided by the Facility Monitoring and Control System (FMCS). In response to the vibration and acoustic requirements imposed by the interferometers, the HVAC system shall incorporate the following features:

- a) The location of machinery, chiller plants, high-velocity exhausts, etc. shall be chosen to limit transmission of vibration and noise.
- b) Equipment shall be provided with vibration isolators and flexible connectors for ducts, electrical conduits, and piping to avoid structural transmission of vibrations and acoustic noise.

- c) Diffusers, grills, fans, heating and ventilating units, and other equipment shall be carefully selected to meet or exceed noise criteria for the serviced area.
- d) Excessive velocity and turbulence in ducts and piping shall be avoided everywhere.
- e) To limit noise transmission through the ventilating ducts, intraduct acoustic attenuators shall be installed where necessary.

2.5.2.1 Climatic Design Criteria

Environment	Hanford	Livingston
Nearest Town	Richland, WA	Baton Rouge, LA
Latitude	47° N	30° N
Longitude	119° W	91° W
Elevation	532 ft above sea level	60 ft above sea level
Summer Outdoor Design Temp.	96 °F _{db} , 68 °F _{wb}	93 °F _{db} , 80 °F _{wb}
Daily Temperature Range	30 °F	19 °F
Winter Outdoor Design Temp.	5 °F _{db}	25 °F _{db}
Clearness Number, Summer	1.05	0.9
Clearness Number, Winter	0.95	0.9
Design Wind Velocity, Summer	3.6 mph	7.5 mph
Design Wind Velocity, Winter	15 mph	15 mph

Table 2.5-1 -- Climatic Design Criteria

2.5.2.2 Inside Design Conditions

2.5.2.2.1 Inside Design Conditions During Normal Operational Mode

Space	Design Temperature/Pressure	Air flow rate
LVEA and VEAs	72 ± 3.5 °F 0.15" wg above ambient	2 cfm/sf (HEPA filtered air)
Optics Lab Vacuum Prep & Assmb. Lab	72 ± 3.5 °F 0.05" wg above adjacent area	2 cfm/sf (HEPA filtered air)
Electronics Test/Maint Mechanical. Shop	72 ± 3.5 °F 0.05" wg above ambient	2 cfm/sf
Cleaning Area Active Storage Long Term Storage	Heat - 65 - 3.5°F Cool - 80 + 3.5°F 0.05" wg above ambient	2 cfm/sf
Inspection/Shipping/ Receiving	Heat - 65 - 3.5°F Cool - 80 + 3.5°F 0.05" wg above ambient	1 cfm/sf

Space	Design Temperature/Pressure	Air flow rate
Facility Control, Computer Users, Tape Room, Computer Mass Storage, and Diag. Support, Changing Room	72 ± 3.5 °F	2 cfm/sf
Offices	72 ± 3.5 °F	As required
Main Lobby	72 ± 3.5 °F	As required
Conference Room	72 ± 3.5 °F	As required
Multi-use / Visitors Area	72 ± 3.5 °F	As required
Mechanical/Elec. Rooms	Heat - 60 - 3.5°F Cool - 85 + 3.5°F	As required
Admin. Assistant	72 ± 3.5 °F	As required
Lounge/ Conf./Lab	72 ± 3.5 °F	As required
Toilets	75 ± 3.5 °F	2 cfm/sf exhaust
Beam Tube Enclosure	No temperature, humidity, or pressurization requirements	No ventilation requirements

Table 2.5-2 -- Inside Design Conditions During Normal Operational Mode

2.5.2.2.2 Inside Design Conditions During Other Modes

These inside design conditions shall occur during rough pumping, regen (regeneration of cryogenic pump) with final pumping, vacuum equipment bakeout, vent, regen, purge with regen and clean room purge with three clean rooms.

Space	Design Temperature/Pressure	Air flow rate
LVEA and VEAs	72 - 3.5 °F 72 + 10 °F 0.15" wg above ambient	2 cfm/sf (HEPA filtered air)
Mechanical Room	Heat - 65 - 3.5°F Cool - 80 + 3.5°F	As required
All Other Rooms	Same as in 2.5.2.2.1	Same as in 2.5.2.2.1

Table 2.5-3 -- Inside Design Conditions During Other Modes

2.5.2.3 Space Humidity Requirements

All occupied spaces inside the Facilities at Hanford and Livingston shall have a relative humidity range from 20% to 70% RH.

2.5.2.4 Insulation Systems

All thermal insulation materials shall be non combustible as defined by ANSI/NFPA 220.

2.5.2.5 Penetrations

Effective sound stopping, non-vibration-transmitting, vapor, dust, and vermin sealing, and adequate operating clearances shall be provided to prevent structure contact where ducts and pipe penetrate walls, floors, or ceilings into occupied spaces.

2.5.2.6 HVAC Air Systems

HVAC air systems design shall comply with the Uniform Mechanical Code (UMC) for Hanford and the Standard Mechanical Code (SMC) for Livingston; applicable SMACNA publications, including but not limited to, HVAC Duct Construction Standards - Metal and Flexible; Rectangular Industrial Duct Construction Standards; Round Industrial Duct Construction Standards; Accepted Industry Practice for Industrial Duct Construction; HVAC Systems Duct Design; and HVAC Air Duct Leakage Test Manual.

2.5.2.6.1 Air Handling Units (AHU's)

- a) AHUs shall have automatic restart capability in the event of Site power failure.
- b) AHUs shall be mounted inside the mechanical rooms in order to avoid roof penetrations.
- c) Refrigerant coils shall not be used in clean environment system, since CFC is a contaminant itself.

2.5.2.6.2 Ductwork

Ductwork shall conform to the following requirements:

- a) Duct system shall be capable of withstanding static pressure variation +10% without pulsating.
- b) Fire dampers shall be provided at duct penetrations through fire-rated walls, ceilings, and partitions.

- c) Ductwork materials shall meet the requirements of Section 2.1.8.

2.5.2.6.3 Air Filters

- a) All filters shall be fire-retardent, non allergenic, and non toxic, with no detectable odors.
- b) Dry filter gaskets shall be closed-cell foamed neoprene or urethane elastomer of sufficient hardness to compress not more than 40% of original thickness when the filter is in position.
- c) High-Efficiency Particulate Air (HEPA) Filter:
 - i) HEPA filters shall be capable of withstanding minimum 90% relative humidity determined dynamically between 70 and 100 degrees.
 - ii) HEPA filters shall bear numbered Underwriter's Laboratories label certifying the filter is UL 586 classified.
 - iii) HEPA filters shall provide, as a minimum, a 99.97% overall efficiency on 0.3 micron particles.
 - iv) Dioctylphalate (DOP) tested HEPA filters are not acceptable. DOP mist is a contaminant.
- d) AHUs shall house prefilters and filters (30% and 90% efficiency respectively).

2.5.2.6.4 Humidifiers

- a) Humidifiers shall be electric, evaporative, or clean steam type.
- b) Electric and evaporative humidifiers shall utilize deionized water as water source (offsite water source) unless a flushing system is incorporated into the humidification unit.
- c) Electrode/jug-type humidifiers are not acceptable.

2.5.2.7 HVAC Hydronic Systems

2.5.2.7.1 Chillers

- a) In general, each chiller shall be a complete, factory-tested, water-chilling package consisting of compressors, capacity control system, water cooler, refrigerant condenser, starters, disconnect switch, and steel base.
- b) Chillers shall be rated in accordance with ARI 540.
- c) Chillers shall comply with the ASME Code, Section VIII.
- d) Control panels shall be provided integral to the chiller unit.
- e) Control panels shall have the capability to interface with the HVAC and Control System (See Section 2.5.5.2).

- f) Chillers shall operate smoothly within the 15% to 100% capacity range without surge or excessive vibration.
- g) Chillers shall have an automatic restart capability in the event of Site power failure.
- h) The contractor shall supply the most cost-effective chiller type using an acceptable alternate refrigerant (No CFCs) as allowed by the Clean Air Act.
- i) The contractor shall comply with the refrigeration equipment room requirements specified in ASHRAE Standard 15-1992, and safety classification of refrigerants based on ASHRAE Standard 34-1992.
- j) No refrigerant shall be present inside the clean air flow stream, by design, single-point failure, or accident.
- k) Chillers shall be air-cooled type.

2.5.2.7.2 Electric Heaters

- a) Electric heaters shall be sheathed type.
- b) Heaters shall be UL listed.
- c) Heaters shall be provided with all necessary safety devices.
- d) Heaters shall be Silicon Control Rectifier (SCR) controlled (i.e., modulating type control) for LVEA and VEAs. All other heaters shall be multi-stage capacity control.

2.5.2.7.3 Water Treatment

- a) If domestic water is not available, then demineralized water shall be furnished (by others) to provide a source of water for humidification.
- b) Chilled water shall be treated for closed system application. Chilled water shall utilize glycol mixture to avoid freezing in winter.

2.5.2.7.4 Pumps

- a) Pumps shall be capable of accommodating static pressure variations of plus or minus 10%.
- b) Pumps shall have an automatic restart capability in the event of Site power failure.

2.5.2.7.5 Chilled Water

- a) Piping larger than 4-inch diameter shall be black steel, schedule 40 or polyethylene.

- b) Piping 4-inch and smaller shall be copper ASTM/ANSI B88, hard-drawn, Type K (underground and exposed use) and Type L (aboveground and concealed use).
- c) Copper fittings shall comply with ANSI/ASME B16.29; joints - ANSI/ASTM B32, Solder Grade - 95TA.
- d) Route piping shall be parallel with building lines, branch runs extending from the top of the mains, and with pipe transitions in the eccentric to avoid cavitation and facilitate venting of air.
- e) Vents at high points and drains at low points shall be provided.
- f) Unions or flanges at equipment connections shall be provided to facilitate removal and maintenance.
- g) Underground piping shall be insulated with polyethylene jacket.

2.5.2.7.6 Valves

- a) Valves shall be angle, ball, check, gate, globe, and automatic or manual balancing types.
 - i) Valves shall have rising stems and open when turned counterclockwise.
 - ii) Valves shall be provided to permit isolation of branch piping and at each equipment item to permit balancing of the system.
 - iii) All valves 2 inches or smaller shall be ball valves.
- b) As a minimum, manual and control valves shall conform to the following:
 - i) Bronze Gate, Check: MSS SP80
 - ii) Cast Iron Gate: MSS SP70
 - iii) Butterfly: MSS SP67, ASTM A126, and ANSI B16.1
 - iv) Ball: FED-STD WW-V-35 or MSS SP72, Class 150, flanged
 - v) Cast Iron Check: MIL-V-18436, Class 125
 - vi) Globe and Angle: MSS SP80
 - vii) Standard Check: MSS SP80 or ASTM A126
 - viii) Non-Slam Check: ASTM A278
- c) Control valve actuators shall conform to the following:
 - i) Shall be electric, pneumatic (large actuators only), or electronic for direct digital control.
 - ii) Shall have a feature that allows conversion to accept new controller output signal without having to replace the motor actuator.

- iii) Valve actuators shall be industrial grade, spring return, or non-spring return type.
- d) Balance valve shall be a circuit setter or an automatic balancing device such as variable orifice, precisely calibrated, and able to preset, balance, and meter the flow. The following shall also be provided:
 - i) Positive cutoff
 - ii) Flow memory
 - iii) Readout ports
 - iv) Vent connection

2.5.2.7.7 Pipe Supporting Elements

With the exception that C-clamps shall not be used, supporting elements shall comply with the requirements of ANSI/ASME B31.1, ANSI/MSS SP-58, and MSS SP-69.

2.5.3 Plumbing Systems

2.5.3.1 Potable Water

2.5.3.1.1 Flushing Water

- a) A potable water connection (standard 3/4-inch hose bib) shall be provided in the Large Item Access Airlock outside the LVEA and in the Cleaning Area and Inspection, Shipping and Receiving in the OSB and VEAs to supply 5 gpm (min.) at 50 psig (max.).

2.5.3.1.2 Backflow Prevention Devices

- a) A backflow prevention device shall be provided to prevent contamination of potable water supply system.
- b) Backflow preventer shall be a reduced pressure principle backflow type in accordance with UPC, Section 1003 general requirements; ASSE 1013-1971.
- c) Domestic cold and hot water shall be provided to all restrooms.

2.5.3.2 Drains and Vents

2.5.3.2.1 Floor Drains

- a) Floor drains shall be provided with traps.

- b) Automatic trap priming device shall be provided.
- c) All required water drains shall be routed to an appropriate waste collection system, as required by Local directives.
- d) Drainage for all restrooms shall be provided.
- e) Floor drains inside of the LVEA shall be connected to a holding tank.
- f) Floor drains at the Cleaning Area, and Inspection, Shipping and Receiving areas of the Mid and End Stations shall be connected to a holding tank. Drain may be connected with other fixtures such as lavatories and service sinks.

2.5.3.2.2 Plumbing Materials

Material selections shall be based on water quality that conform to the minimum requirements in UPC.

2.5.3.2.3 Emergency Eyewash and Shower Equipment

- a) Eyewash/showers shall be a combination-type single-head emergency shower and eyewash.
 - i) Number of installations shall be based upon the number of people and the size of the hazardous area.
 - ii) Use materials that shall resist corrosion.
 - iii) Emergency sign, hand and foot control shall be provided.
- b) Supply line shall be designed using a minimum water pressure of 30 psi or an acceptable portable system.
- c) Eyewash/showers shall comply with ANSI Z358.1.
- d) Eyewash/showers shall be placed adjacent to emergency exits. For LVEA, eyewash shall be packaged type and air pressurized.

2.5.4 Fire Suppression and Detection Systems

The design, installation, and testing of the fire suppression and detection system shall be in accordance with NFPA 14.

All fire alarm, detection, and fire suppression systems shall be interconnected, and monitored by central fire reporting systems in accordance with NFPA Standard. Fire suppression systems for Facility Control Room, Computer Users Room, Computer Users Room, and

Tape and Computer Mass Storage Room shall be suitable for use with computers and other electronics.

Hand-held fire extinguishers shall be placed in all buildings and rooms in accordance with NFPA 10.

2.5.5 Facility Monitoring and Control Systems

The status of all major fans, pumps, hoists, vents, dampers and other Facility equipment which can produce vibration, acoustic noise, or electrical interference shall be reported to the Facility Monitoring and Control Systems (FMCS) and updated periodically. This shall allow operators to track possible instrumentation interference problems to specific pieces of Facility equipment, even if that equipment is activated autonomously or intermittently.

Data reported to the FMCS shall be stored for subsequent reporting. Reports shall include a log of all duty cycles of all connected equipment. As a minimum, the duty cycle data shall include the time when equipment starts or stops (minimum of 1 second accuracy and sample rate; maximum of 10 second accuracy and sample rate), and any out of tolerance performance (e.g., excess vibration, voltage fluctuations, low flow rate, etc.).

2.5.5.1 Control System Design

- a) The sequence of operation shall be presented clearly and concisely.
- b) Each mode of operation shall specify operating ranges, valve and damper positions (fail open or closed) for the following functions:
 - i) Heating
 - ii) Humidification
 - iii) Dehumidification
 - iv) Cooling
 - v) Economizer

2.5.5.2 HVAC Control and Monitoring System

2.5.5.2.1 Control Devices

- a) All sensor or transmitter control devices shall be provided as a completely assembled unit, manufactured and assembled by one supplier, with calibration traceable to National Institute of Standards and Technology (NIST, formally NBS) standards.
- b) Sensor or transmitter assemblies shall be factory assembled, calibrated, and shipped as a single entity.

- c) Assembly shall be compatible with the HVAC control and monitoring system.
 - i) All control devices shall be selected for minimum accuracy of 1%, except temperature and dew point sensors shall have a minimum accuracy of 0.5% over the control range.
 - ii) Components shall be specified with regards to functional attributes and not solely on manufacturer model numbers.
 - iii) Controls shall be housed in enclosures that are ventilated and shall be mounted indoors in an air-conditioned environment.

2.5.5.2.2 Operator Interfaces

Operator interface shall be provided for status monitoring from the Facility Control Room that provides on-line operator interaction, supervision, coordination, and control through the use of a LAN interface.

2.5.5.2.3 Control Points

- a) The system shall control all significant points of the central chiller and boiler plant and the air-handling systems.
- b) The system shall interface with the environmental control and monitoring system.
- c) The monitor and control points for the HVAC system shall include, but not be limited to, the following.
 - i) Temperature (local and remote)
 - ii) Humidity (local and remote)
 - iii) Flow-rate (air and hydronic systems)
 - iv) Pressure
 - v) Remote start/stop status, and run time
 - vi) Filter differential pressure indication
 - vii) Dew-point monitoring
 - viii) System on-off operation (local and remote)
 - ix) Changeover control
 - x) All necessary boiler, chiller, pump, condenser, and damper controls (status, run time, and operation selection)

2.5.5.3 Particulate Monitoring System

There is no requirement for particulate monitoring by the Facility systems. Portable particulate monitors (if any) shall be provided by LIGO.

2.5.6 Cranes

2.5.6.1 General Crane Requirements

- a) Electric under-hung bridge cranes and monorail shall be required as described in Section 3.5.6.
- b) Cranes and monorail hoists shall comply with the applicable requirements of CMAA, ASME HST M4, ANSI B30.2, B30.10, NEC Article 610, and AWS D14.1.
- c) Cranes and monorail hoists shall operate in a non-hazardous environment.
- d) Cranes and monorail hoists shall have a 20-year design life based on CMAA class "C" service.
- e) The hoist for each crane and monorail shall be electric wire rope type and shall conform to the requirements of ASME HST M4.
- f) The cranes covering the LVEA and VEAs shall be a special design. The three crane manufacturers that have the capability to manufacture these cranes are American Crane & Equipment Inc., Cranenectics, and Heco Pacific.

2.5.6.2 Crane Capacity

The LVEA and VEA cranes shall have a rated capacity of 5 tons.

2.5.6.3 Lift Height

The hook height for the cranes is 26 feet 6 inches.

2.5.6.4 Crane Electrification

Crane electrification shall be by a reeled-cable or festooned system.

2.5.6.5 Hoist Reeving and Wire Rope System

- a) The hoists shall have a double reeving system and true vertical lift capability.
- b) The ropes for the hoists shall consist of one right and left regular lay and shall be sized for a minimum 5:1 safety factor.

2.5.6.6 Hoist Brakes

Hoists shall be equipped with a double braking system. The emergency holding brake shall be applied automatically when power to the brakes is removed.

2.5.6.7 Crane Drives

- a) Hoist drives shall have a variable speed to maximum 25 fpm with creep mode capability. Hoist drive shall include "soft" start and stop feature.
- b) Trolley and bridge drives shall have two traveling speeds, 20 fpm and 80 fpm and shall include "inching" capability.

2.5.6.8 Crane Control

The cranes shall be operated by a pendant control station suspended from the bridge. An emergency stop button shall be incorporated in the pendant which shall set all brakes and stop all crane motion when depressed.

2.5.6.9 Drip Pans

All cranes shall be provided with stainless steel drip pans installed under motors, gear boxes, hoist drums, and any other components where leakage of grease, oil, or other contaminants could occur. Drip pans shall be designed to permit easy removal of collected lubricants/contaminants.

2.5.6.10 Manual Load Lowering Capability

The crane hoist shall have an emergency load lowering capability such that in the event of a power failure or any other equipment failure, the crane operator has the capability of manually lowering any load up to the rated capacity from any hook height.

2.5.6.11 Special Requirements

- a) A visual warning device shall be provided on the crane to caution the personnel when either the trolley or the bridge is in motion.
- b) An overload sensor and alarm light shall be provided to halt the hoisting operation and alarm the operator when the load exceeds the preset maximum.
- c) Rails and wheels shall not create particulates such as paint/coating chips, rust particles, etc.
- d) Interlocks shall be provided to prevent interfacing cranes from colliding

2.6 Electrical

2.6.1 Area Classification

- a) There are no areas in this Facility that are defined by the NFPA as "Hazardous Locations". The contents and processes used in this Facility do not necessitate using equipment or installation practices suitable for hazardous locations.
- b) Fume hoods and exhaust fans materials of construction shall be suitable for materials being handled or exhausted.

2.6.2 Site Power

The electrical system receives power from the local servicing utility, or a Rural Electrification Administration (REA) affiliate, depending on the Site location. Power shall be brought onto the Site, and shall be continued to the primary switchgear by underground cable at Hanford and pole mounted lines at Livingston.

2.6.3 Electrical Equipment

- a) Electrical equipment shall be designed in accordance with ANSI C2 and NFPA 70 (NEC).
- b) Motors: Fractional and integral horsepower motors shall conform to NEC Article 430-7 code letter G or better, NEMA MG1, UL, and NEC, continuous duty induction type. Motors shall meet or exceed nominal full-load efficiency of 91 %.
- c) Electrical equipment that contains electronic devices or sub-assemblies shall be able to meet the electromagnetic interference (EMI) emission limits expressed in FCC Rule 15 subpart J, Class A.
- d) Transient voltage suppression devices or equipment that provides transient suppression shall comply with UL 1449 requirements.
- e) Electrical equipment and circuits shall be located in the Facility so as to minimize influences upon the LIGO experiment and data-handling equipment.

2.6.4 Receptacles

Receptacles in office areas shall be distributed with a minimum of one duplex receptacle on each wall, with spacing not to exceed 12 feet on center, unless otherwise indicated.

Receptacles for portable lighting and small electrically powered tools shall be provided around the perimeter of the LVEA/VEAs at 50-foot intervals.

2.6.5 Lighting

2.6.5.1 Illumination

Illumination levels shall be as specified in this paragraph for each occupancy type. Lighting instruments, and fixtures shall be distributed and arranged to reduce glare and spectral reflection.

Occupancy	Illumination Level [fc]
General Offices	50
Workrooms	50
Corridors	25
Storage Areas	10
Laser and Vacuum Equipment Area	5 ²
Cleaning Area and Inspection Areas	100
Mechanical Equipment Rooms	25
Restrooms	30
Public Assembly Areas	30

Table 2.6-1 -- Illumination Levels

- a) Illumination levels shall be measured at 30 inches above finish floor (AFF) unless otherwise specified.
- b) Interior lighting color shall have a Color Rendering Index (CRI) of 75 or greater as rated per the Illuminating Engineers Society of North America (IESNA) Handbook.
- c) Lamp selection shall be based on current industry standards for power efficiency ratings.
- d) Lighting fixtures shall be selected with a criteria that factors lumen efficiency, beam control, cleanliness, acoustic noise, and EMI shielding performance.
- e) Low Pressure Sodium (LPS) lighting shall not be used. High Pressure Sodium (HPS) lamps with a CRI greater than 60 shall be used outdoors.

² Normal operations at a minimum of 5 foot-candles. Portable work lights shall be provided for operations that require more illumination.

- f) Areas that are furnished with lamps exhibiting non-instant-on operating characteristics shall include auxiliary lamps that provide reduced illumination levels during the period that the main lamp achieves full brightness.

2.6.5.2 Controls

- a) Lighting controls for office and corridor type spaces shall be local, unless otherwise specified, and switched to provide approximately 1/3, 2/3, and full illumination levels.
- b) Lighting circuits in the Mid and End Stations shall be remotely controllable. Lighting circuits in the Corner Station shall not be remotely controllable.
- c) Lighting controls for closets and for spaces under 80 square feet shall provide one level of lighting only.
- d) Refer to Section 2.6.7.5 - Power Distribution System
- e) The panels and circuits feeding the vacuum and CDS equipment shall not be controlled remotely.

2.6.5.3 Emergency Lighting

Self-contained (battery pack) emergency lighting in accordance with OSHA Standards and NEC Article 700 shall be used in all occupied areas. There are no plans to have on-site power generation due to the vibrations emanating from a reciprocating internal combustion engine.

2.6.6 Crane

The LVEA crane electrical power, controls, and readout systems shall meet the requirements of the clean environment. The power electronics in the crane drives shall not introduce excessive EMI into the LVEA.

2.6.7 Electrical Power Characteristics

Electrical power shall be provided by two distinct systems (i.e., Facility, and Technical Power Supply). Large motor loads such as air-handling equipment and vacuum roughing pumps, vacuum equipment bakeout heaters, and lighting shall be fed from the facility power network. Sensitive electronic equipment shall be fed from a technical power network. The two networks differ by the amount of electrical isolation and transient voltage suppression that is provided.

2.6.7.1 Facility Power

Facility electrical power characteristics shall be in accordance with ANSI C84.1-1982 and ANSI/IEEE Std. 141-1986, and shall meet the following minimum requirements:

Parameter	Range
120 volts nominal	108 to 132V ($\pm 10\%$)
480 volts nominal	432 to 528V ($\pm 10\%$)
Voltage Harmonic Content	5% Total Harmonic Distortion (THD)
Frequency	60 Hz ± 1 Hz

Table 2.6-2 -- Facility Power Characteristics

Transients shall not exceed +10% of the specified voltage for a duration not exceeding 200 microseconds.

2.6.7.2 Technical Power

- a) Technical electrical power shall be derived from the Facility Power network.
- b) Technical power shall be available for sensitive electronic equipment directly related to the LIGO experiment, including CDS equipment.
- c) Technical power feeders shall be isolated from Facility power feeders by using ultra-isolator transformers and transient voltage surge suppressors on the transformer primary winding connections.
- d) Technical power shall not be common with any other Facility loads that are 480V or lower.
- e) The power quality of the technical power system shall meet the performance levels indicated in FIBS PUB 94 and shall meet the following minimum requirements.

Parameter	Range
120 volts nominal	110 to 125V (+4%, -8%)
480 volts nominal	440 to 500V (+4%, -8%)
Voltage Harmonic Content	5% THD for nonlinear loads
Frequency	60 Hz ± 1 Hz

Table 2.6-3 -- Technical Power Characteristics

2.6.7.3 Uninterruptible Power Supply Power

The Uninterruptible Power Supply (UPS), serving the FMCS power equipment shall meet the following requirements.

- a) Safe shutdown power for the FMCS shall be provided by a UPS located at the Corner Station. This UPS shall be applied for the central system located in the Facility Control Room only.
- b) If required, UPSs for the Detector System's Control and Data System (CDS), and the Vacuum Equipment System's Monitor and Control System (MCS) are specified and provided by Others.

Parameter	Range
RF Emissions	In accordance with FCC Part 15, Subpart J, Class A
Common Mode NRR	-120 db up to 100 kHz
Voltage Harmonic Content	5% THD
Transverse Mode NRR	-60 dB up to 100 kHz
Surge Protection	IEEE 587/ANSI C62.41 Category B
Acoustical Noise	Less than 50 dBA at one meter distance
Total Harmonic Distortion	5% for nonlinear loads
Voltage Regulation	$\pm 2\%$
Frequency	60 Hz \pm 1 Hz

Table 2.6-4 -- UPS Power Characteristics

2.6.7.4 Backup Power

There is no requirement to provide backup power for this Facility.

2.6.7.5 Power Distribution System

- a) 25% spare capacity shall be provided throughout the Facility and Technical Power distribution systems.
- b) Power distribution panels and equipment shall be clearly identified.
- c) Power distribution diagrams and circuit schedules of the distribution panels shall be provided.
- d) Lighting circuits shall be switched by local wall-mounted toggle switches and remotely-actuated contactors or circuit breakers, as appropriate for locations mentioned in Section 2.6.5.2

2.6.7.5.1 Electric Outlet Reference Designator

An identification designator shall be printed and affixed near each electrical outlet to identify the circuit breaker panel, circuit breaker designator and voltage.

2.6.7.5.2 Circuit Breaker Reference Designator

A unique identification designator shall be printed and affixed near each circuit breaker correlating with the outlet reference designator.

2.6.7.6 Bakeout Power

- a) Bakeout heater power shall be provided by a combination of portable transformers directly connected to the utility power system and distribution panels in the LVEA and VEAs.
- b) Connections to the utility power system shall be made by the utility only.

2.6.8 Materials

- a) Copper conductors, buses, and transformer winding shall be used throughout the electrical system, except the 13.8 kV circuits and switchgear shall use aluminum conductors.
- b) All air plenum and cable chase cables shall be shielded, and rated as air plenum type.
- c) Plastic insulated and jacketed cables shall be in conformance with NFPA and IEEE smoke evolution and flame spread requirements.
- d) Polymeric materials shall not introduce Volatile Organic Compounds (VOC) or out-gassing products in the enclosed spaces.
- e) Conduits and raceways carrying 480Y/277 V and 208Y/120 V power shall be made of galvanized steel.
- f) Cables conducting power shall be constructed to minimize EMI.
- g) Junction boxes shall be galvanized or cold rolled steel.

2.6.9 Grounding

The Facility shall have a power equipment grounding system in accordance with NFPA 70 (NEC).

2.6.9.1 Facility Ground Subsystem

- a) The Facility grounding subsystem shall provide a “green wire” safety ground in compliance with the National Electrical Code - NFPA 70.
- b) The facility power shall be grounded only at the neutral of the transformer in accordance with the NEC.

2.6.9.2 Technical Ground Subsystem

- a) The technical ground subsystems consisting of islands or clusters of related equipment shall provide a “quiet” ground that is connected to the Facility ground subsystem at only one point. That point shall be at the neutrals of the technical power transformers.
- b) The dc resistance between the facility and technical ground circuits shall be at least 1 mega-ohm when the single connection is open-circuited.
- c) The various technical power and ground subsystems shall have dc isolation resistance of at least 1 mega-ohm between each other.
- d) All single-phase and three-phase transformers shall have grounded neutrals in accordance with the NEC. Grounding shall be low-resistance type.
- e) The technical ground shall be designed and installed in accordance with the topological shielding concept.
- f) LVEA and VEA technical grounds shall be connected to the technical power center transformer secondary neutral to reduce EMI.

2.6.9.3 Lightning Protection Subsystem

- a) The lightning protection subsystem shall form a girdle around each of the buildings and physically circumscribes all other grounding subsystems. This ground network shall dissipate the charge and current that results from a lightning strike to any of the buildings.
- b) Lightning protection shall be designed in accordance with appropriate provisions of NFPA 780, UL 96 and UL 467.
- c) *Note that the Beam Tube Enclosures shall not be provided with lightning protection.*
- d) Transient voltage surge suppressors shall be integrated into the power distribution system to provide overvoltage (coincident and transverse mode) protection.

- e) Transient voltage surge suppressors and isolation transformers shall follow a topological shielding structure.

2.6.9.4 Equipment Fault Protection Subsystem

This grounding subsystem is part of the Facility ground and shall be provided in compliance with NFPA 70. This ground system is also referred to as the "green wire" ground.

2.6.9.5 Resistance to Earth

- a) The dc resistance to earth from any point of the Grounding System shall be 10 ohms or less.
- b) Where 10 ohms cannot be obtained with basic electrode configuration due to high soil resistivity, rock formations, or other terrain features, alternate methods for reducing the resistance to earth shall be considered.

2.6.9.6 Grounding Plates

- a) Technical ground plates shall be provided at each technical power isolation transformer. The connections between the ground plates and the grounding cabling shall be bolted, to allow for isolation and testing. These ground plates shall be isolated from the Facility ground with appropriate hardware. The dc resistance between these grounding plates and other grounds shall be 1 mega-ohm or more when open-circuited.
- b) The grounding plates shall be 3/8 inch (thick) by 2 inches (wide) by 18 inches (long) minimum copper bar with six non tapped 3/8" holes.
- c) The grounding plates shall be located appropriately to allow movement of equipment in the LVEA. They shall be mounted 12 inches (min.) above the floor and 4 inches from mounting surfaces on insulating supports or other appropriate devices.
- d) Facility grounding plates shall be provided at workbench locations and spaced at 12 foot intervals (minimum) around the perimeter of the Tape and Computer Mass Storage Room, Optics Lab, Vacuum Preparation and Assembly Lab, and Electronics Test and Maintenance Room.

2.6.9.7 Bonding

All metal-to-metal bonds within the Facility shall be in accordance with NEC requirements for electrical equipment and devices and ASHRAE recommendations for ductwork and air handling equipment.

2.6.10 Fire Detection System

A Fire Detection System in accordance with NEC Article 760 and NFPA 72E in concert with the Fire Suppression System defined in Section 2.5.4 shall be provided.

2.6.11 Doors and Controls

- a) Power shall be provided as required for motorized doors.
- b) Door Control Stations shall be adjacent to the door opening and provided on both sides of the wall. Provisions for manual override shall be provided.
- c) The ability to lockout the operation of either door control shall be provided.
- d) The ability to switch control from either door control station to the other shall be provided.

2.6.12 Optics and Vacuum Preparation and Assembly Labs

These Labs shall be provided with power and grounding in accordance with the Utilities Matrix shown as Table 3.5.1.

2.6.13 Facility Control Room, Electronics Test and Maintenance Area, Computer Users Area, General Computing, and Tape and Computer Mass Storage Room

- a) Power in the Facility Control Room shall be technical power.
- b) Lighting shall be filtered, and electromagnetically shielded.
- c) Technical ground plate shall be provided, at transformer location.

2.6.14 Beam Tube Enclosures

- a) Provisions shall be made to feed a nominal 5-kW of electrical power to the Service Entrances which are located at Beam Tube vacuum ports at 780-foot intervals along the Beam Tube length. This 5-kW power is for future vacuum pumps, a CDS rack.
- b) There are no provisions for general illumination lighting inside the BTEs. This shall be accomplished with portable work lights as required, and provided by LIGO Operations.

2.6.15 Electromagnetic Compatibility (EMC)

LIGO interferometer equipment is sensitive to stray electromagnetic field interference, particularly at radio frequencies. Attention shall be paid to stray magnetic loops from power distribution circuits, grounding networks, and EMI from lighting and power supplies and equipment power controllers.

The Facility shall be designed to achieve EMC within the Facility in accordance with MIL-STD-461D Section 6.3.

Electrical power for the cranes and hoists is not filtered. The LIGO experiment will be off-line when cranes are used in the VEA/LVEAs.

2.6.15.1 Perimeter Penetrations

- a) Vents, ducts, louvered openings, pipes, conduit, etc., that penetrate the Facility's perimeter (i.e. exterior walls and roof) shall not receive special treatment to reduce conducted RF signals that may enter the building.

2.6.16 Communication Systems

The Facility shall be served by an internal communications system consisting of a combination of analog and digital telephones and intercoms. The system shall provide sufficient capability to serve the needs of widely dispersed teams working on coordinated installation and integration tasks.

The equipment shall consist of:

- Administrative telephones with on-site and off-site access
- Tie-ins to a Local Area Network that serves the entire Facility
- The telephone and CDS (provided by LIGO) shall share fibers of the CDS optic fiber backbone.

2.6.16.1 Conduits

- a) All communication conduits shall be routed separately from other conduits.
- b) Materials shall be galvanized steel, of intermediate metallic conduit grade or heavier.
- c) Conduit and raceway networks shall be bonded and electrically continuous in accordance with NEC.
- d) Homerun phone and data circuits that run in air plenums shall be plenum rated.

2.6.16.2 Distribution Boxes

All distribution boxes shall be supplied with a non-conductive, fire-resistant back mounting panel.

2.6.16.3 Facility Data Network

A data network shall be provided to carry signals of the FMCS. This network shall share fibers of the CDS fiber-optic backbone cable. The network shall connect all Station buildings, and the Corner Station Chiller Plant.

2.7 Vibration Isolation

The Facility vibration criteria for the Hanford, Washington Site and the Livingston, Louisiana Site are defined in Appendix C, Special Building Needs, of the LIGO Facility Strawman Design. The LIGO goal is to design and build a completed, operating Facility which does not increase the Power Spectral Density (PSD) plots by more than a factor of four above the natural background. This is to be accomplished over the frequency range from 0.1 Hz to 100 Hz, measured at the foundation for the Laser and Vacuum Equipment Areas (LVEA/VEAs). Exceptions may be allowed over narrow frequency bands above 10 Hz, to permit specific operating equipment to exceed these levels caused by a spike in the foundation PSD at the operating frequency of specific equipment.

The LIGO Standard Spectrum (LSS) in $m/\sqrt{\text{Hz}}$ is shown in Figure 2.7-1. The measured displacement spectrum shall not be exceeded by a factor of two except for spike frequencies above 10 Hz.

The final vibration criteria is defined in TDM 20 and the spike amplitude criteria is summarized as follows:

Narrowband Vibration Requirements for the LVEA and VEA Slabs (vibrations produced by "powered" facility equipment: motors, pumps, transformers, etc.)

0.1 Hz < f < 1 Hz

The rms acceleration (RSS of three axes, measured along the vertical and two orthogonal horizontal axes) resulting from each narrowband excitation in the frequency band from 0.1 Hz to 1 Hz must be less than $2.4 \times 10^{-7} \text{ m/sec}^2$.

1 Hz < f < 50 Hz

The rms acceleration (RSS of three axes, measured along the vertical and two orthogonal horizontal axes) resulting from each narrowband excitation in the frequency band from 1 Hz to 50 Hz must be less than $5 \times 10^{-4} \text{ m/sec}^2$.

f > 50 Hz

The rms acceleration (RSS of three axes, measured along the vertical and two orthogonal horizontal axes) resulting from each narrowband excitation in the frequency band above 50 Hz must be less than 3×10^{-9} m/sec².

Also it is noted that vibrations from environmental effects shall be controlled. At least 95 percent of the time, the vibration and acoustic levels shall not exceed the limits specified in the broadband or narrowband vibration requirements or the acoustic criteria defined in Section 2.8.

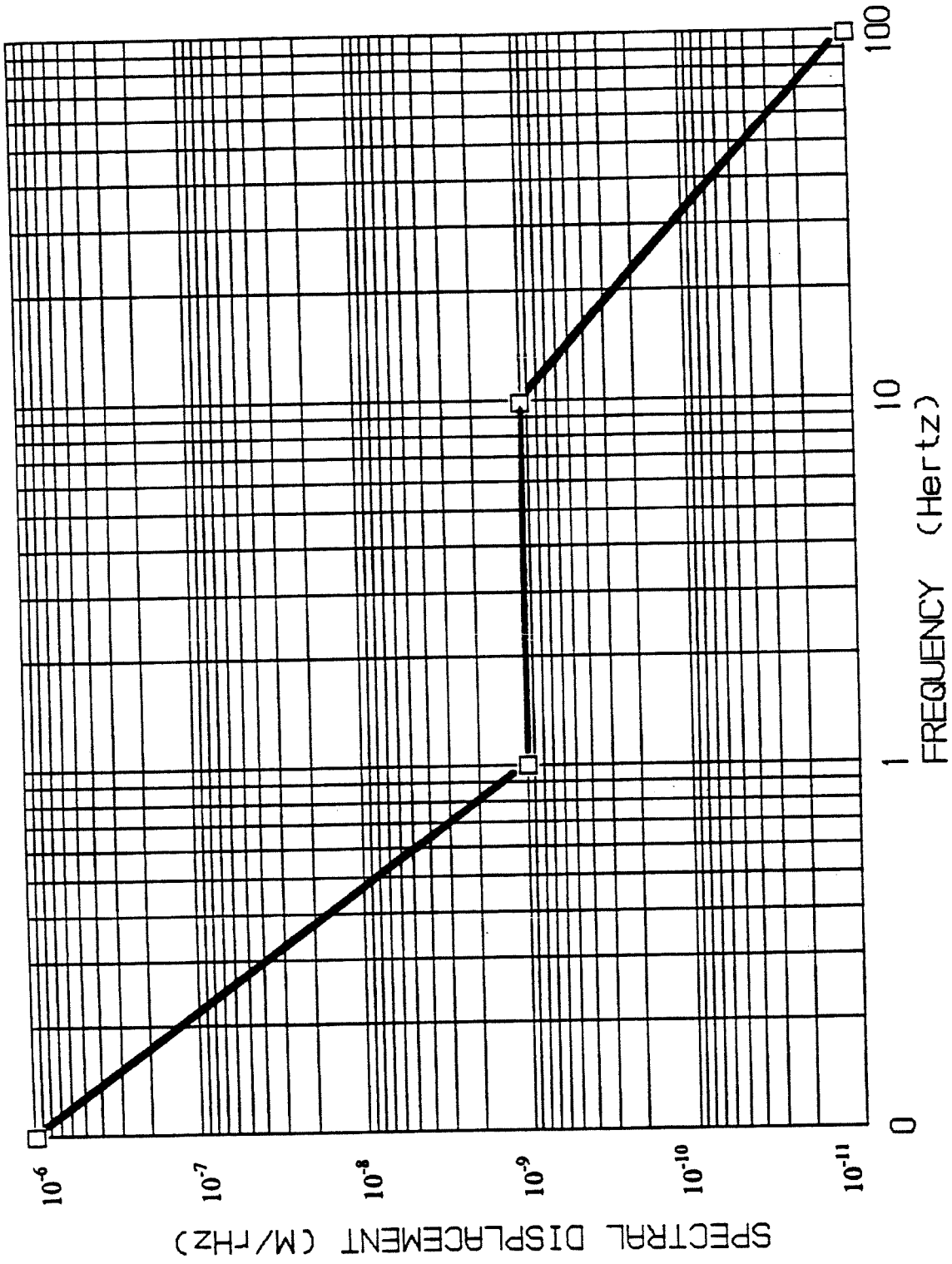

Figure 2.7-1 -- Ambient PSD Predictions

2.8 Acoustics

2.8.1 Laser Facility and End Stations Background Noise

The acoustic background level due to mechanical equipment associated with the building Facility shall be limited to a PNC 50 (Preferred Noise Criterion) above 63 Hz. The following table describes the low frequency requirements at 10 feet above the LVEA and VEA finish floor levels.

Frequency	Sound Pressure Level (0 dB ref: 2×10^{-4} dyne/cm ²)
f > 63 Hz	PNC-50
f = 63 Hz	66 dB
f = 31.5 Hz	64 dB
f = 16 Hz	61 dB
f = 8 Hz	57 dB
f = 4 Hz	55 dB

Table 2.8-1 -- LVEA/VEA Acoustic Requirements

2.8.2 Offices Space Background Noise

Office space background noise environment shall be designed to a PNC 35.

2.8.3 Reverberation Times

In order to control reverberant noise, the LVEA and Vacuum Equipment Areas at the Mid and End Stations shall be designed to a reverberation time of no more than 2.5 seconds at the mid-frequencies (500 and 1,000 Hz.).

2.8.4 Exterior to Interior Noise Control

Exterior to interior noise reduction shall be approximately 50 dB at the mid-frequencies. This shall be designed for a source located on the ground outside the Facility such as a heavy truck as measured in the LVEA and Vacuum Equipment Areas at the Mid and End Stations.

The design shall not include control of rain-generated noise.

2.9 Verification and Testing

This section describes the verification process of the design performance requirements contained in preceding parts of this Section 2, and identifies additional testing beyond that already specified.

2.9.1 Verification Methods

2.9.1.1 Analysis

The design effort shall be subject to analysis by computation, by application of experience and engineering judgment, or by adoption or correlation of test and/or performance data documented on other similar projects. It is mandatory that such analyses be documented for the LIGO Facilities in a manner readily understood. Such documentation shall indicate the source(s) if basic data was used, the method of computation or the formulas used, the step-by-step analytical process used, and the conclusion.

2.9.1.2 Inspection

Inspection is the visual determination of an item's qualitative or quantitative properties such as tolerances, finishes, and identification.

2.9.1.3 Demonstration

Demonstration is the determination of qualitative and quantitative properties and performance of an item, and involves proof-by-doing without use of external resources. It is normally accomplished in conjunction with a test activity.

2.9.1.4 Standard Test

The standard test determines the qualitative and quantitative properties and performance according to standard test specifications and procedures specified in applicable accepted standards, manuals, regulations, and/or codes.

2.9.1.5 Specific Test

The specific test determines the qualitative and quantitative properties and performance according to nonstandard test specifications and procedures. Specifications shall include requirements, procedures, and plans for specific tests.

Where test results, experience, or judgment indicates that an item's malfunction could significantly impact performance of real property facilities and equipment, or results in unsafe conditions for users, operators or maintainers, that item shall be subject to corrective action.

2.9.2 Requirements and Procedures

Special test requirements and procedures as well as standard inspection and test procedures necessary to meet the verification requirements in 2.9.3 through 2.9.7 shall be developed. Necessary special instructions relative to tests and inspections shall be identified. Materials and

certain equipment, as well as pavement and concrete mix designs, shall also be identified within the construction specification as items to be submitted for review by the Construction Manager and approved by the A-E's Engineer. Test procedures and test results shall also be generated by the Construction Contractor and submitted to the Construction Manager for review. All labor, equipment, and material involved in performing and documenting the tests shall be the responsibility of the Construction Contractor. The Construction Manager shall witness the test to ensure compliance with approved procedures and review documentation of test results.

2.9.3 Mechanical

2.9.3.1 Testing, Adjusting, and Balancing of Building Systems

Testing and balancing of building HVAC and Hydronic systems shall be conducted by firms certified by Associated Air Balancing Council (AABC) in those testing and balancing disciplines similar to those required for this project.

2.9.3.2 HEPA Filters

Field certification tests on installed HEPA filters shall be performed in accordance with IES-RP-CC-006-84-T, "Ambient Particle Aerosol Challenge and Air Particle Counter - Downstream Filter Scan Test Method."

2.9.3.3 Fire Protection

The fire suppression and detection systems shall be tested in accordance with NFPA 13A.

2.9.4 Electrical Tests

All test results shall be recorded and submitted in formal documentation by the Contractor for review by the Construction Manager.

2.9.4.1 Grounding

Facility grounding tests shall be conducted in accordance with the recommendations in IEEE Std 81-1983 and IEEE Std 81.2-1991.

2.9.4.2 Electromagnetic Interference

The Facility shall be "sniffed" for sources of EMI. RFI and EMI that is within the LIGO experiment pass-band shall be remedied on a case-by-case and cost-effective manner. Methods of remediation shall include but are not limited to filtering, shielding, relocation, or bonding.

2.9.4.3 New Equipment

New equipment shall be tested for operation as recommended by the manufacturer and UL 674.

2.9.4.4 Short Circuits

Equipment and conductors rated at 600V and less shall be tested to ensure that the wiring system and equipment is free from short circuits and from grounds other than required grounds.

2.9.4.5 Continuity

All wiring shall be tested for conductor continuity.

2.9.4.6 Insulation Resistance

All new conductors shall be tested for an insulation resistance value of 1 mega-ohm or greater, with respect to the nearest grounded metal.

2.9.4.7 Power Cables

Tests of 5 kV and higher voltage power cables shall be conducted as follows:

- A. Cable manufacturer shall furnish certified test reports per AEIC CS 5, CS 6 and UL 1072, for all tests performed.
- B. The completed cable shall be tested for Corona Discharge and shall comply with the AEIC requirements.
- C. High voltage DC field testing before and after installation shall use test voltage(s) as recommended by AEIC S-68-516, CS 5 and CS 6.

2.9.4.8 Isolation Resistance

The grounding subsystems isolation resistance shall be tested for 1 mega-ohm isolation between each other.

2.9.4.9 Electric Power Characteristics

To ensure compliance with 2.6.7, the A-E shall take required measurements of Site-available power and submit a formal report for review and approval.

2.9.4.10 Phase Rotation

Phase rotation shall be per NEMA. All panels, 3-phase outlets, 3-phase equipment, motors, etceteras shall be tested for correct rotation.

2.9.4.11 Alarm Systems

All alarm systems shall be tested for each alarm condition.

2.9.4.12 Controls and Interlocks

All controls and interlock circuits shall be tested for proper and safe performance.

2.9.4.13 Motor Insulation

Motor insulation resistance shall be measured before energizing per IEEE Standard 43.

2.9.4.14 Illumination

Lighting and illumination compliance with Section 2.6.5.1, shall be determined by field measurement.

2.9.5 Architectural

2.9.5.1 Painting

All shop and field painting shall be inspected and approved by a National Association of Corrosion Engineers (NACE) certified inspector.

2.9.6 Vibration Testing

All rotating equipment meeting a specified vibration criteria shall be shop tested and the tests shall be witnessed by the Owners representative. The vibration tests shall include steady-state and transient (i.e., start-up) operating speeds. The vibration limits shall be met at all specified frequencies. Skid mounted rotating equipment shall be tested to demonstrate that the specified vibration limits on the skid and the specified vibration transmissibility of the skid isolation system has been met at all specified frequencies. The shop tests shall include the affects of all equipment attachments such as electrical conduit, fluid piping, etc. that may "short circuit" the skid isolation system.

In addition, field acceptance tests shall be required to demonstrate that the field installed equipment satisfies the vibration requirements and these tests shall be witnessed by the Owner's Representative

2.9.7 Acoustics

2.9.7.1 HVAC Background Noise

With all HVAC systems on in their normal operating condition, the sound pressure level measurements shall be made at the center of the critical areas to determine the octave band sound pressure levels. Measurements shall be made with a type 1 sound level meter and associated octave band filter. Octave band levels shall be taken at center frequencies ranging from 4 Hz to 8 kHz.

2.9.7.2 Reverberation Times

Reverberation time measurements shall be made in the 500 and 1,000 Hz octave frequencies. They shall be made near the center of the critical spaces.

3. Hanford Design Description

3.1 General

3.1.1 Laser and Vacuum Equipment Area

The Laser and Vacuum Equipment Area (LVEA) located at the Corner Station contains major laser and vacuum equipment (provided by Others) on an isolated mat foundation within an unclassified clean environment. The equipment arrangement provides adequate space for the operation and maintenance of the laser and vacuum equipment for three interferometers. Some provisions for up to two additional interferometers are provided for in a future adjacent structure that would be located northeast to the plan. Provisions are made for delivery of large equipment through two large overhead doors and an airlock at the plan east end of the LVEA. Movement of equipment within the LVEA is by an overhead crane system (see Section 3.5.6).

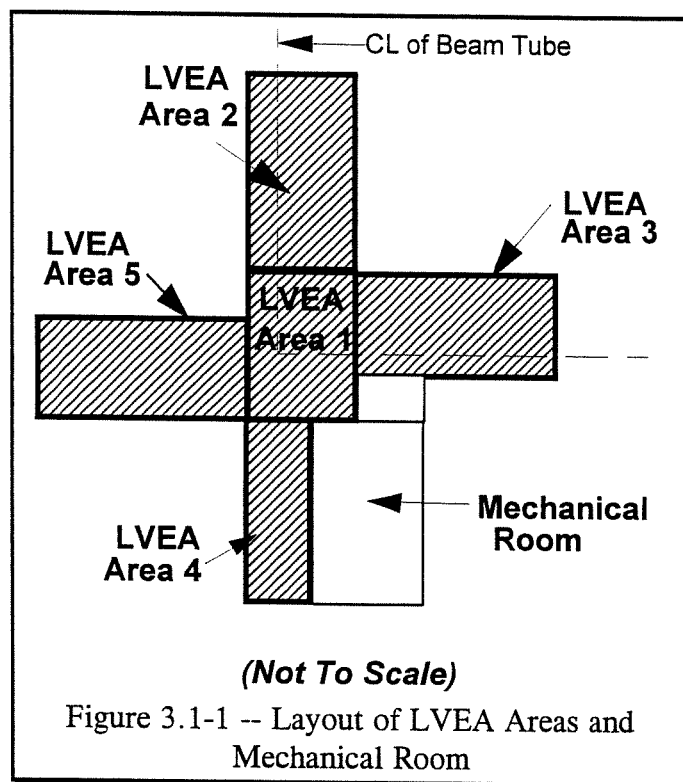

3.1.2 Operation Support Building

The Operation Support Building (OSB) is located at the Corner Station, and contains the administrative, control, and maintenance and service areas for support of equipment and operations of the Facility. These areas are arranged into related groups for either services, controls, or administrative activities.

The maintenance and support areas containing the Optics Lab, Electronic Testing and Maintenance, Vacuum Preparation and Assembly Lab, and Mechanical Shop are grouped to be accessible to the Inspection/Shipping and Receiving, and the Cleaning Areas. The Optics Lab and Vacuum Preparation and Assembly Lab spaces are clean environments (similar to the LVEA -- Section 2.4.1). Access to the Optics Lab, Vacuum Preparation and Assembly Lab, Cleaning Area, and LVEA (via the Cleaning Area) areas is through a Change Room and a clean vestibule.

The Facility Control Room, General Computing, Computer Users Room, and Computer and Mass Storage Areas are grouped and linked with a common access floor system for ease of electronic connections

The office area contains offices for scientists and management personnel are grouped between the control areas and the lobby areas.

The lobby areas containing a Multi-Use Room, Rest Rooms, Conference Room and Kitchen facilities are grouped to the plan south of the offices areas. The Multi-Use Area is sized to accommodate exhibits of the LIGO operations with video presentations as well as conferences for up to 50 participants. The Conference Room doubles as a lounge and library.

Entrance to the non-public areas of the Facility is through the door adjacent to the Administration Assistant's Office. This provides a check point for entering other areas of the Facility. This door can also be locked from outside access to provide a conference area for the public that includes not only the Multi-Use Room but also the Conference and Kitchen facilities. See following table for space square footage.

Space Name	PSF ¹	ASF ²	GSF ³
Multi-Use Room	1200	1280	--
Large Staff Offices (4)	600	768	--
Small Staff Offices (12)	1200	1200	--
Administrative Assistant's Office	120	150	--
Conference Room	600	488	--
Storage	80	168	--
Kitchen	480	166	--
Open Office	1200	1912	--
Facility Control Room	900	1245	--
General Computing	630	476	--
Computer Users Room	460	477	--
Tape and Computer Mass Storage Room	480	604	--
Entrance Vestibule		125	
Inspection/Receiving and Shipping	400	540	--
Cleaning Area	400	551	--
Vacuum Prep. & Assembly Area	720	610	--
Optics Lab	900	990	--

¹ PSF -- Program Square Footage

² ASF -- Actual Square Footage

³ GSF -- Gross Square Footage (includes walls)

Space Name	PSF ¹	ASF ²	GSF ³
Electronics Test and Maintenance	1290	1150	--
Mechanical Shop	900	640	--
Change Room	200	196	--
Active Storage	600	558	--
Long-Term Storage	600	588	--
Shower/Toilet	--	133	--
Mechanical Room	--	448	--
Men and Women Toilets	--	335	--
Janitor's Room	--	35	--
Totals:	14,360	15539	18,800

Table 3.1-1 -- OSB Square Footage Summary

3.1.3 Mechanical Equipment Rooms

The Mechanical Room at the Corner Station provides distribution of conditioned air to the LVEA. Air is supplied by ducts in the ceiling through registers and returned through near-floor level ducts which in turn return air through wall plenums to the air handling units in the Mechanical Room.

The Mechanical Equipment Room is located adjacent to the LVEA.

3.1.4 Chiller Plants and Utility Buildings

The Chiller Plant for the Corner Station is remotely located from the LVEA to reduce the vibration and noise impacts. The plant contains equipment for chilling water used in cooling air supplied to both the LVEA and OSB.

Other utility buildings necessary for the operation of the Corner, Mid, and End Stations include a Maintenance Shop, Electrical Substation, Hazardous Storage Building, and Trash Enclosure.

3.1.5 Mid Station and End Station

The Mid and End Stations are scaled-down operations of the Corner Station used only for periodic maintenance of interferometer components housed inside vacuum chambers located in the Vacuum Equipment Area (VEA). The VEAs are not classified as cleanrooms, but material selection and sealing reflect a cleanroom approach, and HEPA filters are used in the supply air system. Supply air is routed to the VEA by ductwork in the ceiling and returned through floor-level wall returns to air handlers in the mechanical equipment room. No rooms in the Mid or End Stations are classified as "cleanrooms."

Also included in these Stations are an Inspection, Shipping and Receiving, Cleaning Area, Experiment Work Area, Change Room, Toilet, and Mechanical Rooms. Large overhead door access to the VEA is through the Inspection, and Shipping and Receiving, and Cleaning Area.

3.1.6 Global and Local Coordinate System Reference

At each Site there is a “Global Coordinate System,” and five “Local Coordinate Systems.” A Local Coordinate System has been established for each of the five Station Locations (i.e., Corner Station, 2 Mid Stations, and 2 End Stations). The Global Coordinate System (i.e., X_G , Y_G , Z_G) is defined by the center line of the beam tube arms (i.e., X_G , Y_G) with the Z_G axis up and normal to the X_G , Y_G plane.

Local coordinates (i.e., X_L , Y_L , Z_L) are determined by Z_L being plumb at each station, and the X_L and Z_L axes are in the same vertical plane as the longitudinal axis of the respective beam tube and Z_G .

The $\{0, 0, 0\}$ point of the local coordinate system at the Corner Station is coincident with the intersection point of the two Beam Tube Arms. This is located at the vertex point of the primary interferometer. The finish floor elevation is 6 feet 1 inch below that point. Similarly the $\{0, 0, 0\}$ point of the local coordinate system at the Mid and End Stations is at the centerline of the beam tube, at specified locations in the Mid and End Stations. Mid and End Station finish floor elevation is also 6 feet 1 inch below the beam tube centerline.

The establishment of these local and global coordinate systems provide a reference system that establishes Facility features (e.g., floor elevation, column locations, etc.), and vacuum equipment features (e.g., vacuum chambers, etc.). The vacuum equipment will be set at their correct locations in the LVEA using the Sites’ global coordinate system, and the Stations will be built according to the relevant Local coordinate systems.

Note that even though the global and local coordinate systems share a common origin, the plane defined by X_L and Y_L will not lie in the same plane as the X_G and Y_G axes unless the Z_G axis is also plumb (i.e., normal to the surface of the Earth) at that origin. This means that over a distance of 4000 meters, the planes defined by X_L and Y_L will differ, with respect to rotation about either X_G or Y_G axes, by up to 0.6214×10^{-3} radians:

$$\left\{ \frac{4000 \text{ meters} * 3.28083 (\text{ft} / \text{m})}{4000 \text{ miles (earth's radius)} * 5280 (\text{ft} / \text{mile})} \right\}.$$

3.1.7 Building Code Analysis

Building code analysis was performed using the accepted regional code in the western United States, the 1994 Uniform Building Code (UBC), and applying the established guideline requirements for a one-story building for occupancy classifications (Chapter 3), the construction types (Chapter 6), the location on the property (Chapters 5 and 6), the allowable

floor area (Chapter 5), allowable area increases (Chapter 5), and height and number of stories (Chapter 5). The building occupancy classification for the Corner Station, Mid, and End Stations is classified as a Type F-2 occupancy (Section 306.1), however the occupancy classification for the OSB at the Corner Station is Type B.

The Corner Station LVEA is 40'-6" high with an area of 34,340 square feet. Based on Table 5-B of the UBC with the allowable area increases from Section 505.1.2, the maximum allowable area of the LVEA is 36,000 square feet with a maximum allowable height of 55 feet. The construction type allowable is Type II-non-rated. A two hour occupancy separation wall will be constructed between the LVEA and the OSB.

The OSB has a maximum height of 39 feet and an area of 18,800 square feet. The is based on Table 5-B with the allowable area increases from Section 505.1.2. The maximum allowable area of the OSB is 24,000 square feet with a maximum allowable height of 55 feet. The construction type allowable is Type II non-rated.

Based on these scenarios, the optimum approach for the Corner Station is to build to the following

- a) Structural steel framing with no fireproofing (Table 6-A).
- b) Emergency exits are a maximum travel distance of 150 feet (Section 1003.4).
- c) Permanent partitions are one-hour construction (Table 6-A).
- d) Roof and ceiling assemblies are non-rated (Table 6-A).
- e) All construction is non-combustible (Section 603).

The height of the Mid and End Station structures is below the allowable 55 feet allowing them to be Type II -- Non-Rated. The square footage allowable for this construction and occupancy type is a basic area of 18,000 square feet.

Based on these scenarios, the optimum approach for the Mid and End Stations is to build to the following requirements.

- a) Structural steel framing with no fireproofing (Table 6-A).
- b) Emergency exits are a maximum travel distance of 150 feet (Sect. 1003.4).
- c) Permanent partitions are one-hour construction (Table 6-A).
- d) Roof/ceiling assemblies are non-rated (Table 6-A).
- e) All construction is non-combustible (Sect. 603).

3.1.8 Building Security

Standard measures for building security are controlled with the door hardware and a master keying system. Exterior doors at the LVEA have electronic sensors to detect whether a door is in the open or closed position for the purpose of maintaining air pressure, cleanliness, and security. The control panel for these sensors is located in the Facility Control Room and is an element of the Facility Monitoring and Control System (FMCS, See Section 3.6.6.1)

Beam Tube Enclosure (BTE) doors will have locks to prevent entry but not exit. The BTE doors will have provisions for installation of intrusion detectors in the future.

3.2 Civil

3.2.1 Potable Water Supply and Treatment

Potable water for the Hanford Site is obtained from an existing water well at the end of the southwest beam tube arm. This well was used during the prior rough-grading phase for construction water and also will be used during subsequent construction phases. The existing pump is used to supply water through a new 6-inch PVC pipeline to an above ground potable water tank and pump at the Maintenance Building.

Potable water for the Livingston Site is obtained from new wells that will be established on the Site.

The water will be treated using chlorination. Potable water is distributed to the LVEA and OSB through a 3-inch PVC pipeline. The average daily water requirement of 3,000 gallons is based on a total of 60 total personnel over a 3-shift 24-hour period using 50 gallons each.

Potable water is supplied to the Mid and End Stations by tanker truck. A 1,000-gallon pneumatic potable water tank and pump with a chlorination system is provided at each of the Mid and End Stations.

3.2.2 Sanitary Sewage Disposal

Sanitary sewage from the OSB is collected and transported by a 4-inch PVC pipeline to a 3,000-gallon septic tank. Effluent from the septic tank is disposed of in a leach field, charged periodically by a dosing pump. Sludge and scum from the septic tank will be collected by a contracted service. The Mid and End Stations is serviced by 500-gallon holding tanks which will be collected by a contracted service when required. From the LVEA there is a 1,000 gallon holding tank with pump to handle washdown waste. This effluent is treated before pumped release to the septic tank, however if contaminants are present that would hinder the septic tank's biological activity, the effluent will be extracted by vacuum truck for disposal.

3.2.3 Firewater Supply

The requirements for firewater available for the LIGO project are based on Table A-III-A-1 of the Uniform Fire Code. For the Corner Station (OSB) portion, based on approximately 19,000 square feet of building and a Type II NR structure, a baseline fire flow of 3,750 gallons per minute for a period of 3 hours is set. Under A-III-A-3.1, a decrease may be allowed for isolated buildings or a group of buildings in rural areas or small communities where development of full fire-flow requirements is impractical. Taking this into consideration, the required fire flow has been set to a rate of 1,875 gallons per minute for a period of 3 hours for the Corner Station. At the Mid and End Station, the requirement for firewater has been omitted based on the isolated nature of the approximately 5,000-square-foot structures, and that the fact buildings will be classified as Type-II NR structure built of non-combustible materials, they contain non-combustibles with the exception of a small amount of electronic equipment, and they are normally unoccupied.

Firewater is supplied to the Corner Station from a 334,000-gallon firewater tank that is filled from the water wells discussed in Section 2.2.6.1. This is enough water to supply fire hydrants spaced approximately 300 feet apart along an 8-inch ductile iron pipe loop around the Facility at a minimum flow rate of 1,875 gallons per minute for a period of 3 hours. This is achieved with two off-the-shelf 1,000 gallons-per-minute pumps.

3.2.4 Access Road

At Hanford the existing 30-foot-wide access road to the Site is graded with 4 inches of aggregate, but unpaved. This access road will remain throughout construction. A surface treatment may be provided during construction to maintain its integrity to the extent possible. After construction, the road will be re-graded, crushed stone aggregate base course added, and paved with 3 inches of asphalt concrete, 24 feet wide (with 3-foot shoulders), to final lines and grades.

At Livingston the existing access road is being paved under a separate contract. This road will be maintained by the Contractor during construction and repaired at completion of construction to meet specifications for quality, smoothness, and tolerances.

3.2.5 Site Roads

All Site roads around the LVEA and OSB will be 20 feet wide, with 3-foot shoulders when possible, and paved with 3 inches of asphalt concrete underlain by 6 inches of crushed stone aggregate base course. Beam Tube service roads will be 20 feet wide, bituminous-treated with shoulders wide enough to accommodate a future 2-lane road if required. Shoulders may need stabilization also due to construction use.

A ramped overpass over the BTE on the southwest arm provides access to the backside of the LVEA and the Mechanical Room. The overpass uses a corrugated metal culvert-type structure over the BTE.

Truck delivery access points to the LVEA and OSB have 8 inches of concrete pavement over 6 inches of an aggregate base course.

3.2.6 Parking Areas

Parking areas are paved with 2 inches of asphalt concrete underlain by 6 inches of crushed stone aggregate base course.

3.2.7 Grading and Drainage

Grading primarily consists of finish grading of existing rough-graded Facility pad prior to construction of Facility or road paving. Prior to paving and or pad construction, testing will be done to ensure the upper 6 to 12 inches of material have been compacted to 95% maximum dry density in accordance with ASTM D 1557, with possible proof rolling required if not achieved.

For the LVEA an approximate 2 foot 7 inch excavation is required due to the differential between the Beam Tube slab elevation and the finish floor of the LVEA elevation, additionally a 30 inch excavation for the concrete foundation will be required within the existing graded pad. The Mid and End Stations (at Hanford and End Station only at Livingston) will also require grading adjustment to accommodate this 2 foot 7 inch differential. The material obtained from this excavation will be used in areas that require additional earthwork beyond that already rough-graded, as well as for the ramped BTE crossover. These additional areas will be cleared, grubbed, backfilled, and compacted in accordance with the geotechnical report recommendations similar to the previous rough-grading package.

All drainage is directed away from the Facilities. Roof drains discharge to grade.

3.2.8 Erosion Protection

Erosion protection at Hanford is primarily for wind and rain, and will consist of 3 to 6 inches (depending on location) of clean aggregate. In some areas, primarily the access road entrance and external to the OSB, ground cover may be used for erosion control as an adjunct to its primary purpose of landscaping.

Erosion protection at Livingston is primarily for rain, and consists of seeding with grasses to hold the soil.

3.2.9 Fencing and Gates

Fencing is limited at both Sites. There is an entrance gate (24-foot, double-swing) and 100 feet of fencing on each side of the entrance access road. There are barriers limiting access to

the backside service roads. Other Facilities requiring fencing and gates are the electrical switchyard, chiller yard, hazardous storage area, etc.

3.2.10 Landscaping

The entrance area of the LIGO facilities may be landscaped with appropriate ground cover material and pop-up sprinkler irrigation.

3.3 Structural

The superstructures of the Corner, Mid, and End Stations are all framed and laid out in a similar fashion. Major superstructure columns are all on a 20-by-20-foot grid and the framing system chosen for the roof and wall is the same. This approach introduces economies and efficiencies of scale since many of the common steel framing members (e.g., girts, purlins, roof girders, etc.) are the same size and length.

Metal roof decking spans 10 feet between roof girders over the LVEA, and between purlins for all other structures. A horizontal bracing system is provided at the roof level to provide diaphragm action that transfers lateral seismic loads to the exterior wall lines.

Exterior walls contain a vertical brace system between columns to transfer lateral loads to the foundation level. Girts are spaced at a maximum vertical distance of 8 feet with two sag rods at the one third points. The interior girts support a 25-gauge metal stud wall which in turn supports the interior wall material.

3.3.1 Chiller Plants

Structures that are required at the chiller plants (e.g., pump housing) for the Corner, Mid, or End Stations are pre-engineered metal structures.

3.4 Architectural

3.4.1 Interior Materials and Finishes

Materials and finishes selected for the LVEA, OSB, and other support buildings are consistent with the function and usage intended for that area. Systems are selected for their quality, durability, and performance. See the following table for materials selected for the rooms and spaces.

Space Name	Floor	Walls	Ceiling	Other
Multi-Use Room	Carpet	GB/ptd ⁴	Exposed	Acoustic Treatment
Large Staff Offices (4)	Carpet	GB/ptd	ACT ⁵	
Small Staff Offices (12)	Carpet	GB/ptd	ACT	
Administrative Assistant's Office	Carpet	GB/ptd	ACT	
Conference Room	Carpet	GB/ptd	ACT	
Storage	VCT ⁶	GB/ptd	ACT	
Kitchen	VCT	GB/ptd	ACT	
Staff Offices (12)	Carpet	GB/ptd	ACT	
Facility Control Room	Access Flr	GB/ptd	ACT	Anti-Static Carpet
General Computing	Access Flr	GB/ptd	ACT	Anti-Static Carpet
Computer Users Area	Access Flr	GB/ptd	ACT	Anti-Static Carpet
Tape and Computer Mass Storage Rm	Access Flr	GB/ptd	ACT	Anti-Static Carpet
Inspection/Receiving & Shipping	Sealed Conc	GB/ptd	ACT	8' Wainscot
Cleaning Area	Sealed Conc	GB/ptd	ACT	8' Wainscot
Vacuum Prep & Assembly Area	SV ⁷	GB/ptd	ACT	
Optics Laboratory	SV	GB/ptd	ACT	
Electronics Test and Maintenance	Access Flr	GB/ptd	ACT	
Mechanical Shop	Sealed Conc	GB/ptd	ACT	
Change/Smock Room	SV	GB/ptd	ACT	
Active Storage	Sealed Conc	GB/ptd	ACT	
Long-Term Storage	Sealed Conc	GB/ptd	ACT	
Mechanical/Electrical Room	Sealed Conc	GB/ptd	Exposed	
Men/Women Toilets	Cer T	Cer T/GB/ptd	GB/ptd	
Janitors Room	VCT	GB/ptd	GB/ptd	
LVEA	Sealed Conc	GB/ptd	ACT	

Table 3.4-1 -- Room Finish Schedule

⁴ GB/ptd -- Gypsum Board, Painted

⁵ ACT -- Acoustic Ceiling Tile

⁶ VCT -- Vinyl Composition Tile

⁷ SV -- Sheet Vinyl

3.4.2 Exterior Siding

The exterior envelope is prefinished, insulated, vertical metal sandwich panel siding that will seal against intrusion of water, air, dust, insects, and animals.

3.4.3 Roofing

Roofing is a heavy-duty, modified bitumen, roofing system, weld-sealed to the insulation and metal roof deck. The large roof areas for both the LVEA and OSB are minimally sloped at one-quarter inch per foot for proper drainage. The roof surface at both Sites will withstand high wind conditions, particularly at the Louisiana Site where winds have exceeded 100 mph during hurricane conditions. Roofs meet Underwriters Laboratory (UL) Class A for fire retardancy and Factory Mutual (FM) Standard Specification Class I-90 for wind conditions.

3.4.4 Clean environments

3.4.4.1 General

The Optics Lab and the Vacuum Preparation/Assembly Lab are clean environments (similar to the LVEA -- Section 2.4.1). These rooms are adjacent to each other and accessed through an interlocked Change Room and Vestibule arrangement.

LVEA and Cleaning Area in the OSB are also "clean environments." Material selection and sealing methods meet the intent of a cleanroom design. At the Mid and End Stations, the VEA and Cleaning Areas are treated in the same manner as the LVEA.

Supply air to all rooms/areas mentioned in this Section is filtered by HEPA filters. All penetrations are fully sealed with silicone sealant to provide a leak-proof surface.

3.4.4.2 Interior Finishes

Interior finishes for areas that are classified as "clean environments" are non-VOC latex paint on gypsum board panels for the wall and ceiling surfaces. A metal wainscot is also applied to walls. The floors are seamless, non-conductive resilient flooring.

3.4.4.3 Air Locks

A double door system provides an airlock between clean areas and the exterior. This is implemented for both personnel and large equipment doors. A clean vestibule serving the Optics Lab and the Vacuum Preparation and Assembly Lab also functions as an airlock. Similar airlocks are provided at the Mid and End Stations even though the VEAs are not "cleanrooms." Personnel doors for these airlocks are provided with gasketing and automatic door bottoms for both the interior and exterior doors to seal and preserve the pressurization

and cleanliness of the spaces. The large equipment doors are paired with an insulated metal coiling door at the exterior and interior openings.

3.4.4.4 Change Room

The Change Room provides a gowning area and a transition into clean areas. Clean garments and shoe covers are donned prior to entering the clean areas. This space is used to carry small items into the clean environment spaces of the Corner Station.

A bench is provided for ease of gowning and ungowning with lockers for storage of unnecessary items and clothing. Twelve lockers (i.e., 2 tiers high by 6 wide) are provided for a moderate amount of clothing, shoes, etceteras that may need to be stored prior to gowning-up and entering the clean areas. These lockers are each 12 inches deep, 12 inches wide, and 36 inches high.

3.5 Mechanical

The following matrix illustrates the types of Facility supplied utilities that are to be provided for each area listed in the left hand column.

Space/Area Name	Electrical						Comm.				Mechanical										Handling				
	Facility Power	Technical Power	UPS	Lightning Protection	Instrumentation Grnd (SRG)	Technical Grnd	Facility Grnd.	FMCs Ethernet/LAN	Telephone	Wireless Transceiver	Potable Water	Sewage	Drainage	Clean/Dry Instrument Air	Reverse Osmosis Water	Exhaust Vents/Hoods	HEPA Filtered Air Supply	Positive Pressure (Inches w.g.)	Hose Bibs -- Washdown	Fire Extinguishers	Gaseous Fire Suppression	Fire Detection & Alarm	Bridge Cranes	Mono Rails	
Notes: 208 = 3 Phase, 208/120 V 480 = 3 Phase, 480/277 V 120 = 1 Phase, 120 V																									
Space/Area Name																									
Provided Throughout UON																									
Laser and Vacuum Equipment Area																									
Mechanical Room																									
Large Item Air Lock																									
Lobby/Reception Area																									
Staff Offices																									
Conference Room																									
Copy/Fax/Storage																									
Lounge/Kitchen/First-Aid																									
Staff Offices																									
Facility Control Room																									
Computer Users Area																									
Tape Computer & Mass Storage Room																									
Inspection Area / Receiving & Shipping																									
General Computing																									
Cleaning Area																									
Vacuum Prep & Assembly Area																									
Optics Lab																									
Electronics Test & Maintenance Shop																									
Mechanical Shop																									
Change Room																									
Active Storage (171)																									
Long Term Storage (172)																									

Table 3.5-1 -- Utility Matrix

3.5.1 Interior Environmental Control

3.5.1.1 Chillers

At the Corner Station, scroll-type air-cooled chillers are placed outdoors and outside the 300-foot exclusion zone from the LVEA. Each chiller is sized for 50% of the design load, and one chiller will always be in standby mode. The Mid and End Stations have similar arrangements of equipment 300 feet from the VEAs. The location and distance are selected to minimize the effects of both vibration and acoustic noise on the LVEA, VEA, and their foundations. Scroll-type chillers generate less noise in low-frequency range (i.e., below 63 Hz). High-frequency noise is dispersed over the distance. The Corner Station Chiller Yard includes provisions for installation of a fourth chiller if argon-ion lasers are selected.

Chillers selected are based on performance using R-22 refrigerant. For scroll-type machines, R-22 chillers offer a variety of size and range. R-134a refrigerant chillers are limited in size, range, and manufacturers. In addition, (perhaps due to its new entry in the market) we are unable to find anyone willing to comment on the reliability of the new machine.

Manufacturers admit that the technology of HFC-134a refrigerant in chillers is not sufficiently developed. All manufacturers will still guarantee parts and services for the life of R-22 chillers. The rationale of selecting the R-22 chillers is cost and performance.

Water chillers serving the Mid and End Station, are 35-ton scroll-type chillers. Two chillers sized for 100% of design load each, serve each Mid and End Station; therefore, one will always be in standby mode in case of maintenance downtime on the other.

3.5.1.2 Water Distribution

Corner Station chillers are located outside the 300-foot exclusion zones. Chilled water piping is routed into the Mechanical Room via buried pipes. Chilled water pipes are insulated. Mid and End Stations have similar arrangements and routing.

3.5.1.3 Air Handling Units

Each air handling unit (AHU) consists of a vaneaxial fan, prefilter, 90% efficiency filter, cooling coil, humidifiers, and mixing box. Vaneaxial fans are selected for their lower acoustic noise below 63 Hz. High frequency noise is attenuated with duct silencers. All fans are direct-driven to avoid the effects of belt slippage or misalignment.

3.5.1.4 Air Distribution

3.5.1.4.1 LVEA and VEAs

Supply air is ducted from the AHUs to a double wall duct, constant volume-type system, and ducted to above-ceiling ductwork of the LVEA and VEAs. Air is then distributed with flexible ducts to HEPA filter modules located in the ceiling surface. Air temperature leaving the AHUs is controlled to meet the most demanding zone. This is done to conserve energy and maintain constant air flow. Duct heaters are provided for fine tuning the space temperature.

LVEA air is returned via a wall plenum provided by the envelope of the double wall. This establishes a unidirectional downward flow pattern across the LVEA. The return air registers are placed at floor level in the walls around the perimeter of the space.

Supplemental duct silencers are provided in the main supply air ducts in the fan room as necessary to attenuate any noise in the air ducts downstream of the AHUs.

Two AHUs are used to supply air to the LVEA. Each AHU includes two fans, two cooling coils, and two humidifiers. Components will be selected such that 3 sets of components out of the 4 will be handle the peak load.

Air distribution for the VEAs of the Mid and End Stations are similar. Supply and return air is provided the same way. There is one AHU per Mid and End Station. AHUs are built in dual cells (each with 100% capacity) with one cell in duty and the other in standby mode.

3.5.1.4.2 Operation Support Building

The technical area of the OSB is served by a built-up AHU. The technical area includes the Facility Control Room, Computer Users Room, Computer Mass Storage, Tape Room, Diagnostics Support, Optics Lab, Vacuum Preparation, and Electric & Mechanical Maintenance.

Supply air is ducted from the AHU to double-duct, variable, volume mixing terminals and ducted to the above-ceiling ductwork. Double-duct, variable volume mixing terminal provide zoned temperature control without reheating. This process conserves energy and utilizes a common air handling system for all zones. Air is then distributed with flexible ducts to air diffusers located in the ceiling surface with HEPA filters. Return air is via return air grilles located at floor level. A constant-air-volume system is provided to the rooms which require air pressurization relative to the surrounding rooms.

The Administrative offices are served by a single-zone variable air volume (VAV) air handling system. The VAV terminals are provided with duct heaters.

3.5.1.5 Space Heating

A life cycle cost (LCC) analysis revealed that electric resistance heaters are more economical than propane, heating oil, and natural gas. Electric heaters will be located inside the AHUs.

An inexpensive power rate, and high initial costs of boilers, pumps, piping, and maintenance of boilers are the main factors for the lower LCC of electric heating. In addition to the low LCC of electric heating, electricity is cleaner energy and will not generate vibrations.

3.5.1.6 Humidification

The humidification method chosen is electric type with regular domestic water at the Corner Station and demineralized water (by others) at the Mid and End Stations. RO water is necessary at the Mid and End Stations since there is no domestic water supply to flush the humidifiers.

Humidification is provided to ensure a minimum relative humidity of 30 percent.

3.5.1.7 Dehumidification

Dehumidification is achieved by cooling the air through the cold air deck in the AHUs. The cold air deck minimum flow is set at 25% RH to ensure humidity control during moderate seasons or hours. Humidity will not exceed 60% RH.

3.5.1.8 Supply Air Filters

All fresh outside air and recirculating air is filtered with a prefilter and a 90% efficiency air filter. In addition, the supply air is filtered with 99.97% efficiency HEPA filters before being distributed to clean environments, LVEA, and VEAs. HEPA filters are located in the ceiling surface.

3.5.1.9 Pressurization

The LVEA and VEAs are to be maintained at a nominal positive pressure of 0.15 inch w.g. In practice, actual space pressure is determined by windward infiltration and leeward exfiltration. Other rooms in the OSB and support areas of the Mid and End Station are also pressurized but at lower levels. See Table 3.5-1 for additional information on pressurization.

3.5.2 House Cleaning Vacuum System

Vacuum cleaning in all clean areas of the LIGO Facilities is to be accomplished with a portable cleanroom compatible vacuum cleaner. This item will be provided by Others.

3.5.3 Clean/Dry Instrument Air

Instrument air is provided for the HVAC control system. Duplex air compressors are located at the chiller yard and feed a common receiver. This system includes a refrigerated air dryer and control panel.

3.5.4 Fire Protection Systems

3.5.4.1 General

Since the Corner Station is a Type II, One Hour building, and the Mid and End Stations are Type II Non-Rated buildings, no fire suppression system is required. However, fire suppression is provided in the Facility Control Room, Computer Users Room, Diagnostics Support Room, and Computer and Mass Storage Room as described in 3.5.4.4.

3.5.4.2 Firewater Supply and Pumping

The fire protection system for the Facility consists of a dedicated firewater storage tank, approximately 300,000 gallons, providing a steady supply of water to two electrically driven 50% firewater pumps, each capable of delivering 1000 gpm at the required pressure.

The firewater pumps are installed per the requirements of NFPA 20, and the firewater tank are in conformance with NFPA 22. An electric jockey pump is provided to maintain required firewater system pressure at all times.

3.5.4.3 Firewater Distribution

An underground firewater distribution system is provided. This distribution system provides firewater to the Corner Station only. There are fire hydrants spaced around the Corner Station at a maximum of 300 feet.

Fire hose stations are provided inside the Corner Station per NFPA 14. These fire hose stations are supplied from a wet standpipe system.

3.5.4.4 Computer Room Area Fire Suppression System

A Clean Agent Extinguishing System (e.g., Inergen or FM2000) is provided in the Facility Control Room, Computer Users Room, General Computing, and Tape and Computer Mass Storage Room. Each of these rooms is protected by a separate fire suppression system.

Each system is a voting type requiring a second detection of a fire prior to release of fire extinguishing agent. Release of agent occurs after a 2-minute delay from the point of the second fire detection. This delay is provided for personnel to evacuate the area. An audible alarm is sounded at the point of the first detection.

Activation of a manual pull station (located by the doors to each of these rooms) discharges the fire extinguishing agent for that room without delay.

3.5.4.5 Fire Extinguishers

Hand-held fire extinguishers are placed in all buildings and rooms in accordance with NFPA 10.

3.5.5 Plumbing Systems

Plumbing systems are provided as indicated in Table 3.5-1.

3.5.6 Mechanical Specialties

3.5.6.1 Corner Station LVEA Bridge Cranes

One monorail with 5-ton electric hoist in the Large Item Access Airlock, and four 5-ton capacity, under-hung bridge cranes are provided in the LVEA. The crane system is primarily used for servicing various vacuum equipment in the building. Cranes operate in a non-hazardous environment and are rated for class "C" service, as defined in the CMAA-70.

Each hoist is operated by a pendant control station from floor level. The pendant control is suspended from a traveling-type trolley that may be moved along the bridge, independent of the hoist. The pendant control station includes all control push-buttons required for operation of the bridge crane.

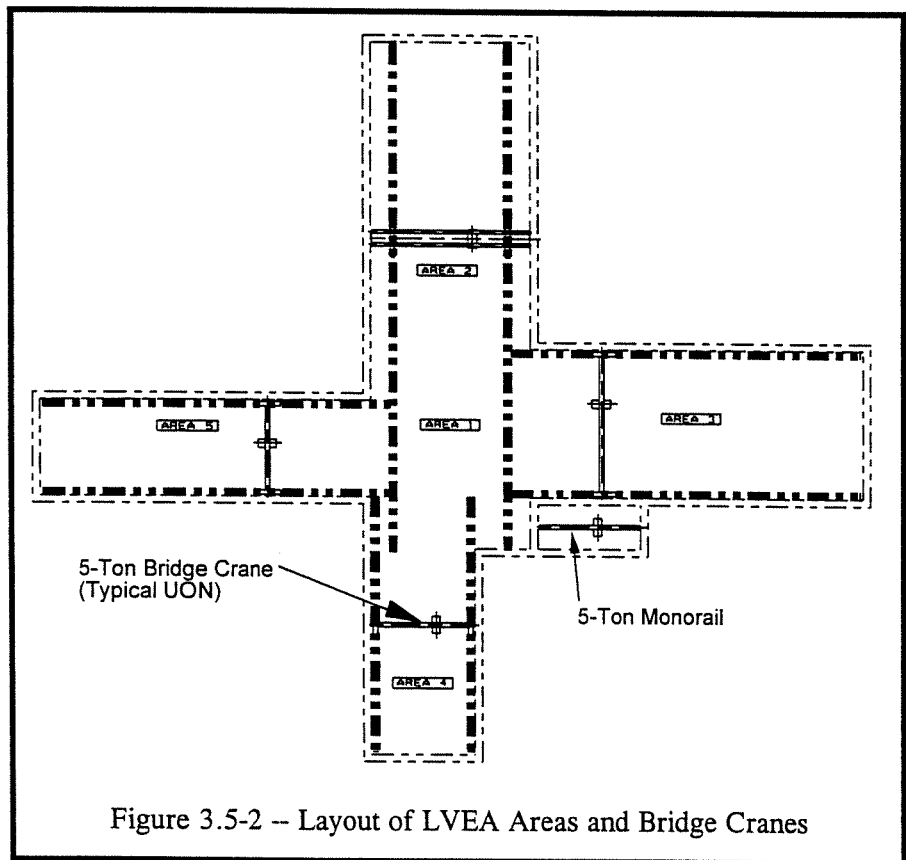

Each bridge and trolley has a double-speed-type drive with a traveling speeds of 20 and 80 fpm.

3.5.6.2 Corner Station Crane and Monorail Locations

Room No. (Area No.)	Description	Hook Height	Span	Approx. Travel
101 and 102 (Area 1 and 2)	5-ton electric under-hung bridge crane. One crane covers both rooms	26'-6"	41'-6"	196'-0"
103 (Area 3)	5-ton electric under-hung bridge crane	26'-6"	55'-6"	126'-0"
104 (Area 4)	5-ton electric under-hung bridge crane	26'-6"	35'-6"	100'-0"
105 (Area 5)	5-ton electric under-hung bridge crane	26'-6"	35'-6"	120'-0"
106 (Area 6)	5-ton monorail with electric hoist	26'-6"		30'-0"

3.5.6.3 Mid and End Station LVEA Bridge Cranes

Each Mid (Hanford only) and End Station includes one 5-ton capacity, under-hung bridge crane to service the BSC and other components in the vacuum equipment room.

3.5.6.4 Mid and End Station LVEA Bridge Crane Locations

Station and Room No.	Description	Hook Height	Span	Approx. Travel
Mid Station Room 202 and 402	Each room has one each 5-ton under-hung crane	26'-6"	33'-6"	75'-0"
End Station Room 302 and 502	Each room has one each 5-ton under-hung crane	26'-6"	33'-6"	55'-0"

3.6 Electrical

3.6.1 Electrical Power Distribution

Primary power was brought from Hanford Reservation Area 400 to the Site via overhead transmission line and then diverted to underground at the highway crossings. Power for the Livingston Site is also be supplied by the local electrical supply company.

Electrical power distribution is at the highest voltage possible, which is the utility voltage, 13.8 kV for Hanford and 13.2 kV for Livingston. Distribution is via aluminum multi-conductor cable that is installed by plow techniques. The cable is not protected by concrete or

conduit, except for road and pavement crossings. The plow-buried cable lies at the edge of the roadway farthest from the beam tube enclosure and parallel to the beam tube. Power enters the site near the Operations Support Building (OSB) and then is distributed to the various buildings in a simple radial-type system with utility pad-mounted transformers adjacent to the outlying buildings. Distribution cable redundancy is not provided.

Power inside each of the buildings is at 480Y/277V and 208Y/120V as needed, with transformers as needed.

3.6.1.1 Facility Power

The table below represents the estimated power requirements for the LIGO facility for each of the two sites

	CONNECTED LOAD ⁸	DIVERSIFIED LOAD ⁹	PEAK LOAD ¹⁰
MID STATION ARM 1			
FACILITY	414.4	146.54	123.64
VACUUM EQUIP.	154.3	11.7	111.32
CDS EQUIP.	23.04	23.04	23.04
Subtotal	591.74	181.28	258
MID STATION ARM 2			
FACILITY	414.4	146.54	123.64
VACUUM EQUIP.	154.3	11.7	111.32
CDS EQUIP.	23.04	23.04	23.04
Subtotal	591.74	181.28	258
END STATION ARM 1			
FACILITY	414.4	146.54	123.64
VACUUM EQUIP.	154.3	7.55	89.47
CDS EQUIP.	38.4	38.4	38.4
WATER PUMP	103	80	80
Subtotal	710.1	272.49	331.51
END STATION ARM 2			
FACILITY	414.4	146.54	123.64
VACUUM EQUIP.	154.3	7.55	89.47
CDS EQUIP.	38.4	38.4	38.4
Subtotal	607.1	192.49	251.51

⁸ Represents the total of all loads that are circuited to the power system.

⁹ Represents the total of all loads multiplied by an array of factors that depend on anticipated concurrent loads and estimated duty factors of equipment.

¹⁰ Represents the total estimated maximum load under certain bakeout scenarios.

CHILLER AND MAINT.

FACILITY	1280	827	1215
VACUUM EQUIP.	NONE	NONE	NONE
CDS EQUIP.	NONE	NONE	NONE
Subtotal	1280	827	1215

OPERATIONS AND SUPPORT

FACILITY	681	201	411
VACUUM EQUIP.	NONE	NONE	NONE
CDS EQUIP.	115.5	115.5	115.5
Subtotal	796.5	316.5	526.5

LVEA AND MECHANICAL

FACILITY	1445	443	411
VACUUM EQUIP. (incl. Bake)	898	218	218
LASER EQUIP.	96	72	72
CDS EQUIP.	183	123.75	123.75
Subtotal	2622	856.75	824.75

SITE TOTALS	7199.18	2827.79	3665.27
--------------------	---------	---------	---------

Table 3.6-1 -- Power Demands for Interferometer, Vacuum Equipment, and Beam Tube Systems

3.6.1.2 Technical Power

Equipment of moderate sensitivity to over-voltages and surges is isolated from the Facility power system via isolation transformers and transient voltage surge suppressers (TVSS).

3.6.1.3 UPS Power

Uninterruptable power is provided at the Corner Station to support critical Facility components only (e.g., the FMCS). The Interferometer, Vacuum Equipment, and Beam Tube Systems provide their own UPSs as required.

3.6.2 Grounding

Grounding is configured in a "ground tree" topology. The overriding philosophy is that heavy power loads and their common mode and switching transients are isolated from sensitive equipment and instruments. Heavy power loads lie at the base of the tree, along with the lightning protection grounding.

Higher sensitivity instruments and equipment are connected to higher points in the grounding tree as appropriate. Generally, single-point grounding philosophies apply. In extreme cases, instruments are opto-isolated from electrical noise sources.

3.6.3 Lightning Protection

The BTEs are not protected from lightning. Lightning protection is provided for Facility buildings only. This is accomplished by a combination of Franklin air terminals connected to a ground counterpoise around the Facility buildings.

Topological shielding concepts have been applied to the design.

3.6.4 Lighting

Lighting fixtures are shielded and gasketed types, to reduce dust contamination and emissions of electromagnetic radiation. Color rendition indices are generally high due to the use of metal halide and high CRI fluorescent lamps. A minimum number of high pressure sodium lamps are used outdoors to illuminate exterior doors and loading docks.

Quartz halogen auxiliary lamps are provided to furnish light while the metal halide arcs are stabilizing. Supplemental lighting will be utilized by the users where required.

3.6.5 Communications

3.6.5.1 Facility Ethernet/Local Area Network

A local area network (LAN) is shared between CDS and FMCS to support the data collection functions of the Facility Monitoring and Control System (FMCS). Baseband communications are provided by the CDS Group.

3.6.5.2 Telephone

Wired analog and digital telephones are provided in areas that are normally occupied. Provisions have been made to allow telephones to be installed along the BTE.

3.6.5.3 Wireless Transceiver

Radio telephones and/or walkie talkies are not be provided as part of the Facility. It will be furnished, if desired, by the User.

3.6.5.4 Security System

The perimeter of the building will not be monitored.

The BTE does not have provisions for an intrusion detection system.

3.6.6 Instrumentation and Controls

3.6.6.1 Facility Monitoring and Control (FMCS)

There are two major data systems at each Site. The science experiment and all science-related data are collected in the Control and Data System (CDS).

The FMCS is the other data system and is part of this Facility Design package. The purpose of the FMCS is to provide central control and monitoring capability for the Facility related equipment and systems. This includes:

- Mechanical Air Handling Equipment
- Refrigeration and Heating Equipment
- Potable Water Equipment
- Chilled Water Circulation Equipment
- Electrical Power Distribution Equipment
- Electrical Lighting Branch Circuits in the Mid and End Stations
- Fire Detection and Alarm System Supervision and Common Control
- Security Supervision (Future provisions only)
- Bridge Crane (on/off)

The FMCS has a centrally located console in the Facility Control Room of the OSB so that all major Facility conditions and operations can be controlled and monitored. The FMCS is electrified from technical power system (see Sections 2.6.7.2 and 3.6.1.2) and back-up power is supplied by a UPS system (see Sections 2.6.7.3 and 3.6.1.3).

The architecture of the system follows a distributed model. This allows each of the various sub-systems, listed above, to have the ability to stand alone in the event that the FMCS backbone communications network fails. Each of the distributed subsystems has a compatible data protocol so that the system can be seamlessly integrated.

The communications backbone is accessible at required points on the Site, so that the functions of the master control console can be reproduced at these points.

The FMCS summarizes, and makes available to the Operator, all conditions-of-state for the equipment that is controlled or monitored by the FMCS.

3.6.6.1.1 HVAC Monitoring and Control System

The HVAC Monitoring and Control System is a subsystem of the FMCS. The purpose of this subsystem is to control and monitor the entire inventory of HVAC-related equipment. For example, the chiller plant and individual electric heater units receive commands for balanced

heating and cooling loads from the HVAC Monitoring and Control System. Circulation pumps and flow balancing valves receive start/stop and modulation commands from the FMCS.

High-level start/stop commands, and running status of all motor-driven equipment, are telemetered to the CDS so gravitational wave events can be verified against Facility events.

CORNER STATION Name	Space/Area	Electrical				Comm.				Mechanical								Handling					
		Facility Power	Technical Power	UPS	Lightning Protection	Technical Grnd.	Facility Grnd.	FMCs Ethernet/LAN	Telephone	Wireless Transceiver	Public Address System	Closed Circuit Video	Chillers	Air Handling Units	Personnel Doors	Large Access Doors	Clean/Dry Instrument Air	Fume Hoods	Positive Pressure	Gaseous Fire Suppression	Fire Detection	Bridge Cranes	Mono Rails
	Provided Throughout UON —▶	X			X		X	X			X										X		
	Laser and Vacuum Equipment Area		X																			X	
	Mechanical Room																						X
	Large Item Air Lock																						X
	Lobby/Reception Area																						
	Staff Offices																						
	Conference Room																						
	Copy/Fax/Storage																						
	Lounge/Kitchen/First-Aid																						
	Staff Offices																						
	Facility Control Room		X																				
	Diagnostics Area		X																				
	Computer Users Area		X																				
	Computer & Mass Storage Room		X																				
	Inspection Area / Receiving & Shipping																						
	Tape Room																						
	Cleaning Area																						
	Vacuum Prep & Assembly Area																						
	Optics Lab																						
	Electronics Test & Maintenance Shop		X																				
	Mechanical Shop																						
	Change Room																						
	Active Storage																						
	Long Term Storage																						

Table 3.6-2 -- Facility Monitoring and Control System Nodes



MID/END STATIONS / BEAM TUBE ENCLOSURE Space/Area Name	Electrical						Comm.				Mechanical								Handling			
	Facility Power	Technical Power	UPS	Lightning Protection	Technical Grnd	Facility Grnd.	FMCs Ethernet/LAN	Telephone	Wireless Transceiver	Public Address System	Closed Circuit Video	Chillers	Air Handling Units	Personnel Doors	Large Access Doors	Clean/Dry Instrument Air	Fume Hoods	Positive Pressure	Gaseous Fire Suppression	Fire Detection	Bridge Cranes	Mono Rails
Provided Throughout UON	X						X									X				X		
Vacuum Equipment Area		X								X			X					X			X	
Mechanical/Utilities Equipment Room										X		X	X				X					
Inspection Area / Receiving & Shipping													X	X								
Cleaning Area													X									
Experiment Equipment Area		X																X				
Change Room													X									
Beam Tube Enclosure																						
Chiller Plants (5 Locations)	X						X					X										

Table 3.6-2 (Cont'd) -- Facility Monitoring and Control System Nodes

3.6.6.2 Fire Detection and Monitoring System

The fire detection devices in the LVEA consist of smoke detectors placed within the return air ductwork. The Mechanical Room, OSB, and Mid and End Stations are protected with photoelectric smoke detection and manual pull stations. The design of the detection system conforms to the requirements of NFPA 72, and the manual pull stations conform to NFPA 101. Detections are reported to the Fire Alarm Control Panel (FACP) located in the Facility Control Room. Status of the FACP and alarm points that are monitored by the FACP are reported to the FMCS. Alarms are radio reported to the Hanford Fire Department at Hanford and no fire department provisions are provided at Livingston.

3.7 Vibration

The primary vibration criteria for LIGO is not to increase the ambient vibration level by a factor greater than four for the PSD spectra measured at the Hanford and Livingston Sites, over the frequency range from 1 Hz to 100 Hz.

The initial ambient PSD curves for the two Sites are shown in 2.7-1. More recent ambient PSD measurements were made for the Hanford Site in December, 1994 and are shown in Figure 3.7-1 and Figure 3.7-2. As noted in the measured ambient PSD curves, the vibration levels within the frequency range from 1 Hz to 10 Hz are very low and indicate that the Sites are extremely quiet. The vibration criteria for the LIGO Facility also states that narrow band spike vibrations can be permitted at the operating frequency of various equipment components at frequencies above 10 Hz.

The dynamic soil properties for the Hanford Site are given in the geotechnical report by Dames & Moore, February 10, 1995. The surface layer is 13 to 20 feet thick with a shear wave velocity of 890 feet/second, a nominal soil unit weight of 110 pounds/cubic foot, and a Poisson's ratio of about 0.4. The dynamic soil properties for the Livingston Site are given in the geotechnical report by Woodward-Clyde, January 6, 1995. The soil below the surficial layer is relatively uniform to a significant depth. The shear wave velocity of the soil is 700 feet/second, with a nominal unit soil weight of 120 pounds/cubic foot, and a Poisson's ratio of 0.4. These soil properties were used in developing the dynamic soil stiffnesses for the modal-frequency analyses of the foundations supporting the scientific equipment.

A 2-inch air gap is used to decouple the LVEA foundation from the superstructure foundations. The 2-inch air gap assures that there will be no interference between the components. Note that vertical settlement does not significantly influence the size of the air gap.

The chiller plant is located several hundred feet from the LVEA foundation at the Corner Station within the available existing graded land. Chiller plants for the Mid and End Stations are located a similar distance from the critical scientific equipment foundation in a direction along the Beam Tube to minimize the requirements for additional land. The chiller plant equipment is on isolated skids that provide an attenuation factor of about 100. This attenuation

is due to the isolation system with a natural frequency of about 3 Hz and the rotating components in the chiller with a frequency of about 60 Hz.

The HVAC equipment in the Mechanical Area adjacent to the critical scientific equipment is supported on isolators to reduce the vibrations transmitted from the equipment to the mechanical equipment foundation. The equipment isolation system consists of a stiff skid that supports the various rotating equipment components, such as fans and motors. The spring isolators are conventional rotating equipment supports. For LIGO, equipment manufacturers will be required to demonstrate that the isolators provide the optimum isolation and attenuation of the equipment vibrations by conducting acceptance tests at the factory Sites, and at completion of installation. These tests are considered to be critical since they will demonstrate that the operational configuration of the equipment, skid, and isolation system satisfy the attenuation requirements for the vibrations produced by the rotating equipment.

There are several possible equipment isolation systems that could be used to reduce the transmission of vibrations from the rotating equipment to its foundation, through the interconnecting soil media, and into the foundations for the critical scientific equipment. Standard mechanical spring isolators provide an inexpensive and efficient means of isolating rotating equipment vibrations from the supporting foundation. However, more efficient isolators, such as pneumatic isolators, can be used at a significant increase in price. High performance pneumatic isolators will increase the cost of an isolated equipment skid system by \$20,000.00 to \$50,000.00. Although this option could be included at some future time, it does not appear that such a cost increase per equipment skid was justified to reduce the spike amplitude caused by various rotating equipment components.

3.7.1 LVEA, OSB, and Associated Superstructure

3.7.1.1 Ground Transmission of Vibrations to the LVEA Foundation

Several finite element models were developed to explore the amplification characteristics of one-meter and two-meter thick foundation slabs for the previous LVEA and Mid Station and End Station scientific equipment as shown in the Facilities 90% Concept Design Report. The current LVEA foundation thickness is 30-inches.

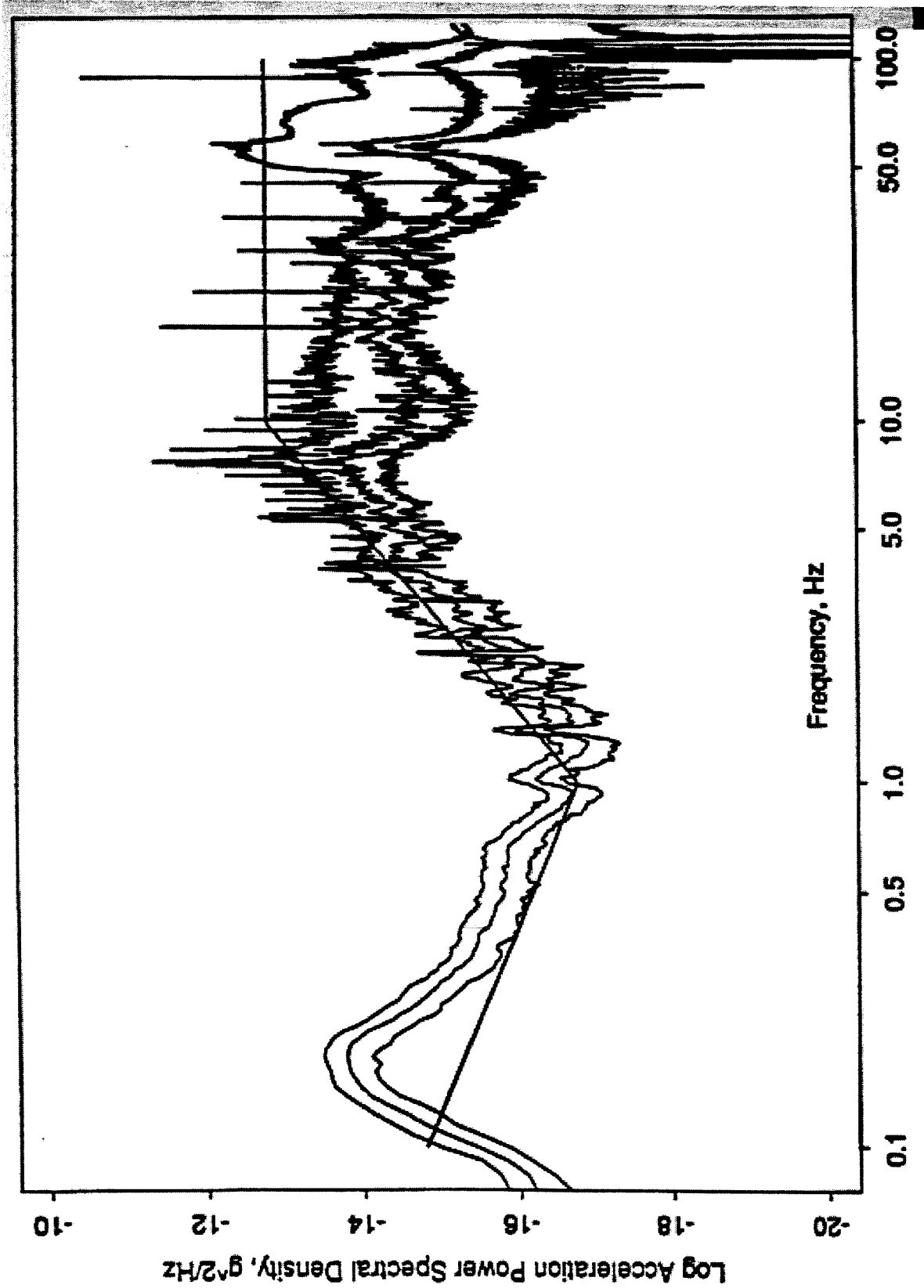

Figure 3.7-1 -- Hanford Corner Station West Axis, Late Night December 12, 1994



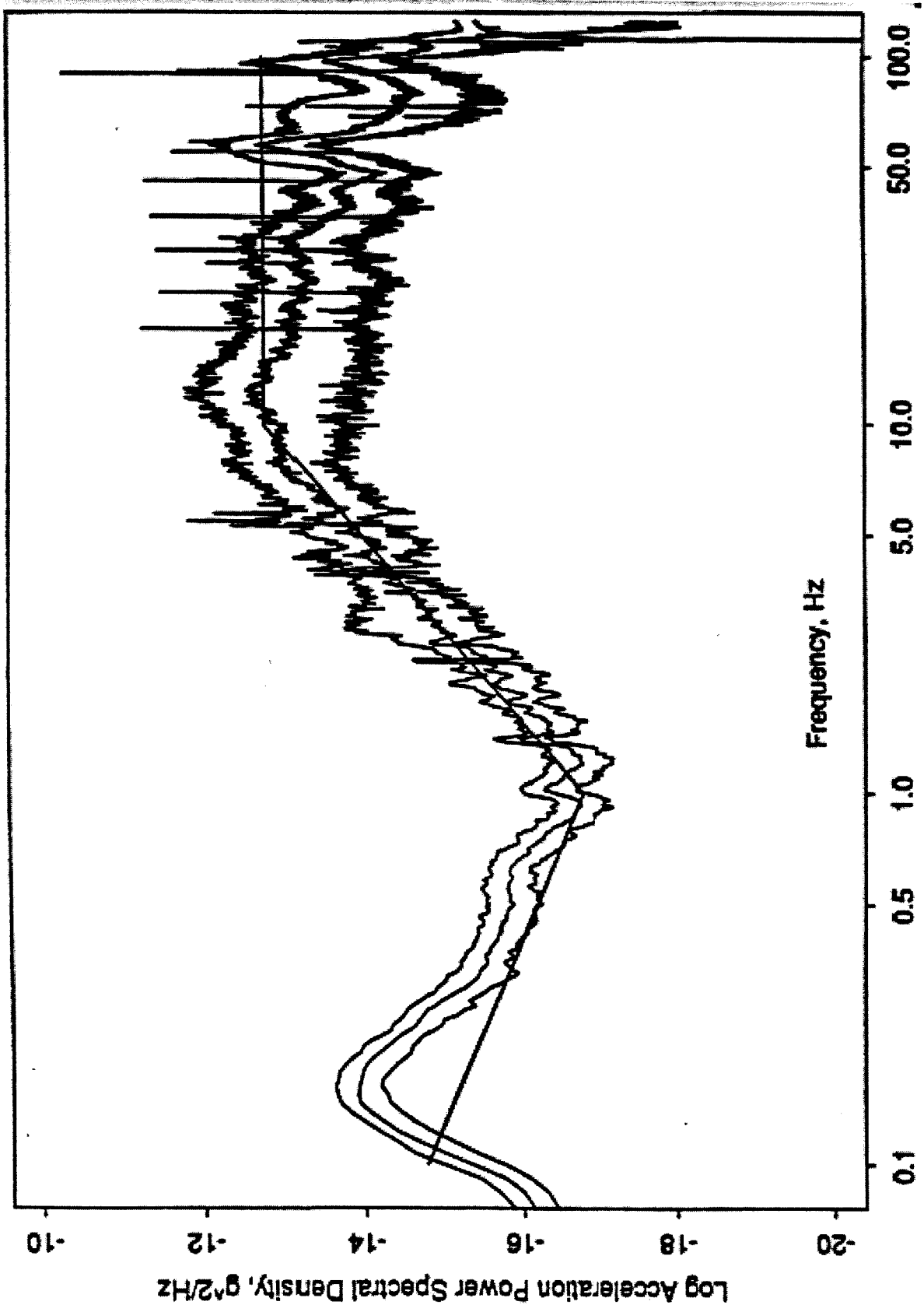

Figure 3.7-2 -- Hanford Corner Station West Axis, Morning Traffic December 13, 1994

3.7.1.2 PSD Analysis of LVEA Foundation

Finite element beam models for the one-meter and two-meter thick LVEA foundations were analyzed using the LIGO Standard PSD curves shown for the Hanford Site Figure 2.7.1, and Figure 3.7-2. The results of these analyses were shown in the Facilities 90% Concept Design Report.

3.7.1.3 Frequency and Modes of the LVEA Foundation

The LVEA foundation mode shapes and frequencies were described in the Facility 90% Concept Design Report. One and two meter thick foundation models were made for the previous configuration of the LVEA foundation slab.

The current LVEA foundation is 30-inches thick and is solid, without voids. This central area is 57 feet by 77 feet in plan view. The other areas of the LVEA foundation are 37 or 57 feet wide and 80 or 120 feet in length.

3.7.1.4 Wind Induced Vibrations

The wind induced vibration analyses of the exterior building for the LVEA and VEA enclosure structures indicate that the wind induced vibrations are relatively small at wind speed less than 30 mph. Measurements made by LIGO at the Moses Lake JAL Hanger indicate that the ambient PSD is only affected slightly by winds less than twenty mph. Estimates of the wind induced vibrations effects of the LVEA foundation will be presented at the PDR presentation.

Other concerns regarding the nature of the effects produced by wind such as the varying air pressures produced within the structures over the LVEA and VEA foundation slabs is being considered by LIGO. Future criteria may evolve from these investigations that could require changes in the wall panel and roof panel frequencies.

It is required that wind, rain and other environmental effects do not produce acoustical or vibrational effects that exceed the design requirements more than 5% of the time.

3.7.2 Chiller Plants

3.7.2.1 Chiller Plant Location

Chiller plant rotating equipment generally produces severe vibrations. It was determined that chilled water supply could be easily transported through a piping system to the HVAC mechanical rooms without significant costs. Therefore the chiller plant is located several hundred feet from the LVEA structures in order to minimize the disturbances from the chiller plant on the critical scientific equipment located in the LVEA.

Estimates for the transmission of rotating equipment vibrations from the chiller plant to the LVEA foundation are based on the surface wave transmission analyses developed by G. N. Bycroft "Forced Vibrations of a rigid circular Plate on a Semi-Infinite Elastic Space and on an Elastic Stratum", Philosophical Transaction Royal Society London, and P. B. MacCalden "Coupled Response of Two Foundations" Fifth World Conference on Earthquake Engineering, Rome Italy. Volume IV of the 90% Concept Design Report, Calculations, Figures B1-26 shows the attenuation that can be expected as a function of the distance from the vibrating foundation. Chiller equipment foundation is approximately 30 feet by 40 feet concrete slab (Mid and End Stations have 20' by 20' slabs).

3.7.2.2 Chiller Plant Equipment Isolation

The chiller equipment rotating speed is 3600 RPM, (60 Hz). The chiller equipment weighs 21,400 pounds and are mounted on a spring isolated skid. Typically the foundation should be about five times the equipment weight to minimize vibrations. Thus a two foot thick chiller foundation is recommended that will be at least five times the weight of the chiller equipment and skid. The typical spring isolators have a natural frequency of about 3 Hz so that the static deflection of the spring isolators are 0.25 to 0.50 inches. Based on Figure B1-27 (of the 90% Concept Design Report), the isolator attenuation factor should be about 0.01 based on 6 Hz isolation frequency and a 60 Hz rotating equipment operating frequency. If the vibration limit of 0.10 g is met at the rotating equipment skid, the inertia force on the vibrating skid is approximately 2,140 pounds. One percent of this force is transmitted through the isolation system to the foundation which results in a chiller equipment foundation acceleration of 0.2 milli-g foundation acceleration for an undamped isolator or a 1.0 milli-g foundation acceleration for a less efficient isolation system.

3.7.3 Mid and End Stations

The mid and end station foundation for the scientific equipment has plan dimensions of 35 feet wide by 77 and 57 feet long respectively and is expected to be 68-inches.

3.7.4 Equipment Isolation Recommendations

3.7.4.1 Spring Isolator Requirements

All rotating equipment skids are supported on spring isolators as the standard means of achieving vibration isolation. However, it is recognized that pneumatic isolation of the equipment skids would be more effective but would have high cost.

In general it is expected that the spring isolator natural frequency for the skid mounted equipment will be in the range of 4 Hz to 6 Hz. This isolation frequency is considerably higher than the typical pneumatic isolator system that has its first mode frequencies in the range of 1 Hz to 2 Hz. The higher isolation frequency of the spring isolation system means that the static deflection of the spring isolators is considerably less than that of the pneumatic

isolator system. However, the spring isolator provides less vibration attenuation for skid vibrations transmitted to the foundation of the mechanical equipment rooms.

3.7.4.2 Short Circuit Prevention

The standard spring isolator design is provided for almost all rotating equipment skids. The reason some of these systems do not perform as designed is due to the lack of attention paid to “short circuits” in the vibration isolation system. These “short circuits” include skids that are heavier than specified that result in the springs being “bottomed out” as a result of overloading. In HVAC equipment it is possible that flexible connections in the duct system are too stiff or not properly aligned so that excessive vibrations are transmitted from the fans to the downstream duct system. All electrical systems are prone to having rigid electrical conduit “short circuit” the vibration isolation system by rigidly attaching the electrical conduit to the equipment skid and to the Facility structure. Similar “short circuits” can arise from cooling fluid or lubricating fluid piping being rigidly attached to the equipment skid and the Facility structure. Each of these conditions can be eliminated by factory acceptance testing of the rotating equipment, followed by field (on-Site) acceptance testing, including the installation of all ancillary components that might potentially “short circuit” or overload the equipment isolations system.

3.7.4.3 High Quality Balancing Requirements

All rotating equipment is balanced so that the bearing support vibrations are limited to plus or minus one mil (0.001 inches). This requirement can be compared to a maximum vibration limit of plus or minus 5 mils which is typically the maximum vibration levels permitted before mandatory shutdown is initiated for maintenance and re-balancing the equipment. High speed equipment that rotates at frequencies above 2000 RPM often is limited to an acceleration limit of 0.10 g to initiate maintenance and re-balancing to prevent vibratory damage to the equipment. Thus a well-balanced machine should not produce bearing support point accelerations in excess of 0.10 g with an expected vibration level of about 0.05 g. Typical equipment vibration limits are shown in Volume IV of the 90% Concept Design Report, Figure B1-45 which is found on page 313 of “Vibrations of Soils and Foundations” by F. E. Richart, Jr., J. R. Hall, Jr., and R. D. Woods. In most cases there is an opportunity to improve the new equipment vibration levels by strictly enforcing the vibration levels during factory acceptance of the equipment. A reduction in the equipment vibration levels by a factor of 0.5 to 0.3 can be achieved by rigorously enforcing the vibration qualification specifications.

3.8 Acoustic

3.8.1 Interior Acoustics

In order to moderate the reverberant sound in the main spaces, acoustical absorption was included in surfaces finishes. The ceiling material is a cleanable acoustical tile having an NRC of approximately 0.6. Additional absorption on the walls in the form of panels is provided to make up the difference in the required absorption. At this point approximately 5000, 1000, and 750 square feet of absorptive panels are anticipated for the Corner Station LVEA, and Mid and End Station VEAs, respectively.

3.8.2 HVAC Noise Control

Based on the noise requirements and preliminary fan sound power levels, the supply duct work has a circular cross-section wherever possible. For the LVEA, noise control requires silencers inside each AHU and perforated-lined circular duct from the AHUs to HEPA filters located in the ceilings of the LVEA. Ducts are sized so as to limit the flow velocities to control noise due to turbulent flow. Refer to Section 3.5.1.4 for additional details on the methods used to reduce HVAC noise.

3.8.3 Exterior-to Interior Noise Control

The exterior building shell is constructed of insulated metal panels. The roof is single-ply roofing. The interior shell is built of 25-gauge metal studs with 5/8-inch drywall. The ceiling is a high TL acoustical tile. Selected areas of the interior wall are lined with 2-inch ISB 150 board for acoustic absorption.

3.9 Interface

Several systems are designed, provided, and installed by Others and, in general, consist of the items listed below. This Section discusses only the physical interfaces between each system and the Facility. In addition to this, design coordination between all design contractors for layout of these systems was instituted during the Final Design Phase.

Refer to Table 3.9-1 for a matrix description of interfaces between the Facility and equipment furnished by Others.

3.9.1 Vacuum Equipment System

The Vacuum System consists of the following subsystems.

- Vacuum Chamber Subsystem
- Vacuum Tube Manifold Subsystem

- Pumping Subsystem
- Valve Subsystem
- Vent and Purge Subsystem
- Bake-out Subsystem
- Monitor and Control Subsystem

3.9.1.1 Initial Delivery of Equipment

At the point of “Joint Occupancy” the LVEA will be accessible and ready to start installation of “Equipment Furnished by Others” in a conditioned environment. A Large Item Access Airlock is provided for controlled and direct access to the LVEA via an airlock space.

The End and Mid Stations on each Beam Tube arm will be individually accepted in a complete condition with fully operating systems and transferred to the Vacuum Equipment Contractor for installation work. A large equipment entry through the Inspection/Receiving and Shipping and the Cleaning Area provides access to the VEA for installation.

The Vacuum Equipment Installer will provide all necessary handling systems to move large pieces of vacuum equipment and their components into the LVEA at the Corner Station, and the VEAs at the Mid and End Stations. The 5-ton monorail in the Large Item Access Airlock will be available for use by the VE Contractor during their installation process.

3.9.1.2 Structural Interface

The LVEA slab at the Corner Station and the VEA slab at the Mid and End Stations will be flat and level. “Levelness” will be determined by the “local” coordinate system at each Station. Local and global coordinate systems are defined in Section 3.1.6.

Anchor bolts for the vacuum chambers, valves, and vacuum pumps will be provided, located, and installed by the Vacuum Equipment Installer.

Thrust reaction anchors and foundations are required where gate valves are located. These anchors require strength and stiffness to resist the large axial forces imposed by atmospheric pressure when the valves are closed and vacuum is on only one side of the valve.

Structural support is provided for two LN₂ storage tanks (provided by Others) located outside the Corner Station, two LN₂ storage tanks (provided by Others) located outside the Mid Stations and one LN₂ storage tanks (provided by Others) located outside the End Stations.

3.9.1.3 Electrical Interface

Electrical power and grounding is supplied from the Facility or technical power systems to several vacuum equipment components. See Table 3.9-1 for interface information on individual components.

Power and ground for the Monitor and Control subsystem is provided by the facility power and ground system. An uninterruptable power supply (UPS) is not provided for this item.

Power for the Vacuum Equipment Bakeout subsystem and all vacuum pumps is provided by the Facility power system. Grounding is to the facility ground.

Large gate valves may be powered by either electricity or by other means. This will be determined by the vacuum equipment designer.

3.9.1.4 Mechanical Interface

See Table 3.9-1 for interface information on individual components.

The Facility bridge cranes will support most of the components of the Vacuum Equipment System. See Section 3.5.6 for further discussion on material handling.

The only physical interfaces are working envelopes and dimensional issues. Mechanical utilities are provided by the Vacuum Equipment Contractor for the operation of the Vacuum Equipment System. This includes a liquid nitrogen storage and distribution subsystem and a vent/purge subsystem. Coordination of planning and layout of these subsystems is required during the Final Design Phase of this project.

3.9.1.5 Instrumentation and Controls Interface

The Facility does not interface with the Monitoring and Control System that is provided by the Vacuum Equipment Contractor.

3.9.2 Beam Tube System

The Beam Tube System consists of the following subsystems and components.

- Beam Tube Segments
- Expansion Bellows
- Pumping Ports
- Baffles
- Beam Tube Support and Leveling Subsystem
- Bake-out Subsystem

3.9.2.1 Structural and Physical Interface

The beam tubes connect to the vacuum equipment at terminus valves located inside the LVEA and VEAs. Next to each terminus valve is a fixed support that anchors the end of the beam tube modules to a concrete mat foundation. These foundations are decoupled from the LVEA and VEA foundations and have sufficient mass and stiffness to minimize movement of the terminus valves when load is applied.

Load	Amount
Vertical (downward)	8,000 pounds
Axial (either direction)	40,000 pounds
Lateral (either direction)	3,000 pounds

The Facility also interfaces with the Beam Tube where it penetrates the interior wall of the LVEA/VEA and where the BTE abuts the Facility exterior wall. This interface is a flexible seal (possibly inflatable) that will allow for some differential movement, minimize vibration and temperature transfer, and provide a tight seal to minimize infiltration of air or dust and eliminate access for insects and animals.

3.9.2.2 Electrical and Grounding Interface

At Livingston, power for initial bakeout of the beam tube will be from portable generators provided by the Beam Tube contractor. Access to the beam tubes is provided so that cables from portable generators can be connected to the beam tube bakeout system.

At Hanford, power for initial bakeout of the beam tube will be from portable transformers provided by the Beam Tube contractor. Access to the beam tubes is provided so that cables from portable transformers can be connected to the beam tube bakeout system. Portable transformer are attached to buried power vaults supplied by Public Utilities District (PUD). Connection and disconnection is done by the Beam Tube contractor.

During and after the Start-Up Phase of LIGO, Facility power and grounding will be provided at the vacuum port locations (i.e., every 780 feet along the beam tubes) for power supply to vacuum pumps, related bakeout, and one instrumentation rack at those locations. Light fixtures are also provided at these locations. Power demand for these three items is estimated at 5 kW and all Service Entrances.

3.9.3 Detector System

The Detector System consists of the following subsystems and components.

- a) Interferometers
 - i) Lasers -- Pre-Stabilized Laser
 - ii) Optics -- Input/Output optics and Core Optics

- iii) Alignment Sensing and Control, Length Sensing and Control
- iv) Seismic Isolation and Suspensions
- b) Control and Data System
- c) Physics Monitoring
- d) Support Equipment

3.9.3.1 Initial Delivery of Equipment

Initial delivery of detector system equipment will be via the loading dock that enters the shipping and receiving area of the OSB, and Mid and End Stations. This is required to maintain the cleanliness of the LVEA. Similar steps are required for equipment entering the “clean environment” areas of the OSB.

3.9.3.2 Electrical Interface

Electrical power is provided to the components of this system via hard-wired connections or, in some cases, wall or floor receptacles for equipment that is movable. In most cases technical power and grounding is provided.

The Control and Data System is not provided with Facility System UPS power.

3.9.3.3 Mechanical Interface

Lasers have a self-contained cooling system that consists of a closed loop of circulating deionized water. This closed loop interfaces with a Facility chilled water circuit near the location of the lasers. The interface consists of a water-to-water heat exchanger. The heat exchanger is provided by the Detector System Contractor. The Facility-provided chilled water line that interfaces with the heat exchanger must supply cooling capacity for two lasers running concurrently.

3.9.3.4 Instrumentation and Controls Interface

The Facilities’ instrumentation and controls will interface with the Control and Data System (CDS) that is provided by the Detector System Contractor to share the fiber optics network for data transmission.

<i>System, Subsystem, or Component</i>	<i>Electrical</i>				<i>Mechanical</i>				
	<i>Facility Power</i>	<i>Technical Power</i>	<i>Technical Grnd</i>	<i>Facility Grnd</i>	<i>Exhaust Vents</i>	<i>Chilled Water Line</i>	<i>Structural Support</i>	<i>Mechanical Support</i>	<i>Dimensional Interface</i>
1. Detector System									
1.1 Control & Data Acquisition System	X	X	X						
1.2 Physics Monitoring	X	X	X						
1.3 Interferometer Subsystem	X	X	X			X	X		
1.4 Support Equipment		X	X						
2. Vacuum Equipment System									
2.1 BSC Chambers				X			X		X
2.2 HAM Chambers				X			X		
2.3 Monitor and Control Subsystem	X			X					
2.4 Main Roughing Pumps	X			X		X			
2.5 Cryo Pumps	X			X					
2.6 Main Ion Pumps	X			X					
2.7 Annulus Pumps	X			X					
2.8 Valves	X			X					
2.9 Vent and Purge Subsystem	X			X					
2.10 Bakeout Subsystem	X			X					
2.11 Turbo Molecular Pumps	X			X					
2.12 Backing Pump System	X			X	X				
2.13 Vacuum Tube & Beam Manifold Supts				X			X		
2.14 LN2 Tank							X	X	X
2.15 Portable Clean Room	X			X					
3. Beam Tube System									
3.1 Beam Tube Supports & Leveling							X		X
3.2 Vacuum Pumps Subsystem	X			X					X
3.3 Vacuum Pump Bakeout Subsystem	X			X					
3.4 Beam Tube Module								X	X

Table 3.9-1 -- Interfaces with Interferometer, Vacuum Equipment, and Beam Tube Systems

4. Referenced Documents

4.1 Federal Standards

Number	Title
FEDERAL STANDARDS	
FED-STD-209	Cleanroom and Work Station Requirements, Controlled Environment
FED-STD-595	Color and Number Identification
Title 29 CFR	Federal Occupational and Health
OSHA 2207	Construction Industry -- OSHA Safety and Health Standards

4.2 Military Standards

Number	Title
MILITARY STANDARDS	
MIL-STD-461D	Grounding, Bonding, and Shielding for Electronics Equipment and Facilities Applications
MIL-STD-1246	Product Cleanliness Levels and Contamination Control Program
MIL-V-18436	Valves, Check: Bronze, Cast-Iron and Steel Body

4.3 Industry Standard Codes

Number	Title
Industry Standard Codes	
ASME Codes	Pressure Vessel Codes, Section VIII & IX
-B16.29	Wrought Copper and Wrought Copper Alloy Solder Joint Drainage Fittings
-B31.1	Power Piping
-Section VIII	Rules for Construction of Pressure Vessels
-Section IX	ASME Boiler and Pressure Vessel Code
BOCA	Building Officials and Code Administrators -- Standard for the Design and Installation of the Fire Suppression System for Life Safety
SBC	Standard Building Code
UBC	Uniform Building Code
UFC	Uniform Fire Code
UMC	Uniform Mechanical Code
UPC	Uniform Plumbing Code

4.4 Industry Standard Specifications, and Guidelines

Number	Title
	Industry Standard Specifications, and Guidelines
AASHTO	American Association of State Highway and Transportation Officials
Manual	Guide for Design of Pavement Structures
Specification	Standard Specifications for Highway Bridges
Specification	Standard Specifications for Transportation Materials
Specification	Standard Specifications for Methods of Sampling and Testing
ACCA	Air Conditioning Contractor's of America
Manual D	Equipment Selection and System Design Procedures
Manual Q	Equipment Selection and System Design Procedures for Commercial Summer and Winter Air Conditioning
ACGIH	American Conference of Governmental Industrial Hygienists
-Chapter 2	General Ventilation
ACI	American Concrete Institute
-117	Standard Specification for Tolerances for Concrete Structures and Materials
-318	Building Code Requirements for Reinforced Concrete and Commentary 60
-530	Building Code Requirements for Concrete Masonry Structures and Commentary
AEIC	Association of Edison Illuminating Companies
-CS 5	Specification for Thermo Plastic and Cross-linked Polyethylene Insulated Shielded Power Cable Rated 5 through 69 kV
-CS 6	Specification for Ethylene Propylene Rubber Insulated Shielded Power Cables Rated 5 through 69 kV
-S-68-516	Ethylene Propylene Rubber Insulated Wire and Cable for Transmission and Distribution of Electrical Energy
AFBMA	Anti-Friction Bearing Manufacturers Association
-9	Load Rating and Fatigue Life for Ball Bearings
-11	Load Rating and Fatigue Life for Roller Bearings
AISC	American Institute of Steel Construction -- Specification for Structural Steel Buildings, Allowable Stress Design and Plastic Design Code of Standard Practice -- Standard Practice for Steel Buildings and Bridges
AISI	American Iron and Steel Institute
AMCA	Air Movement Control Association
-99	Standard Handbook
-211	Certified Ratings Program, Error Performance
-311	Certified Sound Ratings Program for Air Moving Devices
-500	Test Methods of Louvers, Dampers and Shutters
ANSI	American National Standards Institute

Number	Title
	Industry Standard Specifications, and Guidelines
-A13.1	Scheme for the Identification of Piping Systems
-A53	Specification for Pipe Steel, Black and Hot Dipped, Zinc Coated, Welded and Seamless
-B16.3	Malleable Iron Fittings
-B16.5	Pipe Flanges and Flanged Fittings
-B16.9	Factory Made Wrought Steel Butt Welding Fittings
-B16.29	Wrought Copper and Wrought Copper Alloy Solder Joint Drainage Fittings
-B30.2	Safety Code for Overhead and Gantry Cranes
-B30.10	Hooks
-B31.1	Power Piping
-B32	Standard Specification for Solder Metal
-B88	Specification for Seamless Copper Water Tube
-C2	National Electrical Safety Code (NESC)
-Z358.1	Eyewashes and Showers Equipment, Emergency
-900	Test Performance of Air Filter Units
ARI	Air Conditioning and Refrigeration Institute
-410	Force Circulation Air Cooling and Air Heating, Coils
-430	Central Station Air Handling Units
-530	Method of Measuring Sound And Vibration of Refrigerant Compressors
-540	Method for Presentation of Compressor Performance Data
ASCE	American Society of Civil Engineers
-7-88	Minimum Design Loads for Buildings and Other Structures
ASHRAE	American Society of Heating, Refrigerating and Air Conditioning Engineers
-15	Mechanical Code for Refrigeration
-52	Method of Testing Air-Cleaning Devices Used in General Ventilation for Removing Particulate Matter
-34	Number Designation and Safety Classification of Refrigerants
-1989 HDBK	Fundamentals
ASME Codes	Pressure Vessel Codes, Section VIII & IX
-B16.29	Wrought Copper and Wrought Copper Alloy Solder Joint Drainage Fittings
-B31.1	Power Piping
-Section VIII	Rules for Construction of Pressure Vessels
-Section IX	ASME Boiler and Pressure Vessel Code
ASSE	American Society of Sanitary Engineers
-1013	Reduced Pressure Principle and Pressure
ASTM	American Society for Testing and Materials
-A36	Standard Specification for Structural Steel

Number	Title
	Industry Standard Specifications, and Guidelines
-A53	Specification for Pipe, Steel, Black & Hot Dipped, Zinc Coated Welded and Seamless
-A123	Standard Specification for Zinc (Hot Dipped Galvanized) Coatings in Iron and Steel
-A126	Specification for Gray Iron Coatings for Valves, Flanges
-A278	Standard Specification for Gray Iron Castings and Pressure, Containing Parts for Temperature
-B32	Standard Specification for Solder Metal
-B88	Standard Specification for Seamless Copper Water Tube
-B280	Specification for Seamless Copper Tube and Air Conditioning and Refrigeration Field Service
-C553	Standard Specification for Mineral Fiber Blanket and Felt Insulation
-D2737	Specification for Polyethylene Plastic Tubing
-E84	Surface Burning characteristics of Building Materials
-F50	Standard Practice for Continuous Sizing and Counting of Airborne Particles in Dust-Controlled Areas Using Instruments Based Upon Light Scattering Principles
-F328	Standard Practice for Determining Counting and Sizing Accuracy of an Airborne Particle Counter Using Near-Monodisperse Spherical Particulate Materials
-F649	Standard Practice for Secondary Calibration of Airborne Particle Counter Using Comparison Procedures
AWS	American Welding Society
-A2.4	Symbols for Welding, Brazing and Nondestructive Examination
-A3.0	Standard Welding Terms and Definitions
-B2.1	Standard for Welding Procedure and Performance Qualification
-D1.1	Structural Welding Code -- Steel
-D14.1	Specification for Welding Industrial and Mill Cranes
BOCA	Building Officials and Code Administrators -- Standard for the Design and Installation of the Fire Suppression System for Life Safety
CGA	Compressed Gas Association
-4.1	Cleaning Equipment for Oxygen Service
CMAA	Crane Manufacturers Association of America
-70	Specification for Electric Overhead Traveling Cranes
CTI (TBS)	Cooling Tower Institute Standards
DHI	Door Hardware Institute
FIPS Pub 94	Guideline on Electrical Power for ADP Installations
IEEE	Institute of Electrical and Electronic Engineers
-43	Recommended Practice for Testing Insulation Resistance of Rotating Machinery
IESNA HDBK	Illuminating Engineering Society North America Handbook

Number	Title
	Industry Standard Specifications, and Guidelines
IES	Institute of Environmental Sciences, Recommended Practices
-RP-CC-001	HEPA Filters
-RP-CC-006	Testing Cleanrooms
-RP-CC-013	Recommended Practice for Equipment Calibration or Validation Procedures
MSS	Manufacturers Standardization Society
-SP58	Pipe Hangers and Supports
-SP67	Butterfly Valves
-SP69	Pipe Hanger and Supports, Selection and Application
-SP70	Cast Iron Gate Valves, Flanged, and Threaded Ends
-SP72	Ball Valves with Flanged Butt Welded Ends for General Service
-SP80	Bronze Gate, Globe, Angle and Check Valves
NACE-STD	National Association of Corrosion Engineers Cathodic Protection
-RP-02-75	Application of Organic Coating to External Surface of Steel Pipe for Underground Service
NASA	National Aeronautics and Space Administration
-NSS/GO-1740.9	NASA Safety Standard for Lifting Devices and Equipment
NEMA	National Electrical Manufacturers Association
-MG1	Motors and Generators
NFPA	National Fire Protection Association
-13	Installation of Sprinkler Systems
-13A	Inspection, Testing and Maintenance of Sprinkler Systems
-54	National Fuel Gas Code
-70	National Electrical Code
-72E	Automatic Fire Detectors
-78/-780	Lightning Protection Code
-80	Fire Doors and Windows
-85B	Standard for Prevention of Furnace Explosions in Natural Gas-Fired Multiple Burner Boiler
-90A	Installation of Air Conditioning and Ventilating Systems
-99	Standards for Health Care Facilities
NIOSH	Technical Report: Guide to Industrial Respiratory Protection
NIST	National Institute of Standards and Technology
NSS	National Safety Standards
SBC	Standard Building Code
SMACNA	Sheet Metal and Air-Conditioning Contractors National Association
-	High Pressure Duct Construction Standards
-	Low Pressure Duct Construction Standards
-	Guidelines for Seismic Restraints of Mechanical Systems

Number	Title
	Industry Standard Specifications, and Guidelines
-	Round and Oval Duct Construction Standards
-	Architectural Sheet Metal
SSPC	Steel Structures Painting Council
-SP-2	Surface Preparation, Hand Tool Cleaning
-SP-3	Surface Preparation, Power Tool Cleaning
-SP-10	Surface Preparation, Near-White Blast Cleaning
UBC	Uniform Building Code
UFAS	Uniform Federal Accessibility Standards
UFC	Uniform Fire Code
UL	Underwriter's Laboratories
-96	Lightning Protection Systems
-181	Factory Made Air Ducts and Connectors
-467	Grounding and Bonding of Equipment
-555	Leakage Rated Dampers for Use In Smoke Control Systems
-586	High Efficiency Particulate, Air Filter Units
-900	Test Performance of Air Filter Units
-1072	Medium Voltage Power Cables
UMC	Uniform Mechanical Code
UPC	Uniform Plumbing Code
USGSA	United States General Services Administration
-	Certification Test for Air Flow Measuring Stations

4.5 Site Specific Reference Documents -- General

Number	Title
SITE SPECIFIC REFERENCE DOCUMENTS	
RFP-YM 193	Appendices A, B, and C of the Request for Proposal No. YM 193 for LIGO Facility Design and Construction Management Support
Washington DOT	Standard Specifications for Road and Bridge Construction
Washington DOT	Standard Plans for Road and Bridge Construction
941208-01	Exhibit I, Vacuum Equipment Specification, LIGO Facility, LIGO Document 1100003 of the LIGO Vacuum Equipment Request for Proposal No. MH 178
941220-02	Beam Tube Module Specification
941228-11	Beam Tube Enclosure Statement of Work and Beam Tube Support Details
950104-01	Utility Conduit Design Calculations and Drawing

4.6 Site Specific Reference Documents -- Hanford

Number	Title
SITE SPECIFIC REFERENCE DOCUMENTS	
OSHA/WISHA	Washington Institute of Safety and Health Administration
Washington DOT	Standard Specifications for Road and Bridge Construction
Washington DOT	Standard Plans for Road and Bridge Construction
941219-01	Hanford -- Land Use Permit
941219-02	Hanford -- Memorandum of Understanding
941219-03	Hanford -- Environmental Assessment
941219-04	Hanford -- Finding of No Significant Impact
941219-05	Hanford -- Report of Geotechnical Survey/Letters of Clarification
941219-06	Hanford -- Staking Survey
941219-07	Hanford -- Topographical Survey/Including Back-up Data and Seven Diskettes
941219-08	Hanford -- Specification and Contract Documents for Rough-Grading
941219-09	Hanford -- Drawings for the Rough-Grading
941219-10	Hanford -- Ground Water-Temporary Permit
950104-01	Utility Conduit Design Calculations and Drawing
950113-01	Hanford -- LIGO Rough Grading (with 12 diskettes)
950201-01	Hanford -- Water Well Drilling Log

4.7 Site Specific Reference Documents -- Livingston

Number	Title
SITE SPECIFIC REFERENCE DOCUMENTS	
Louisiana DOTC	Standard Specifications for Road and Bridge Construction
Louisiana DOTC	Standard Plans for Road and Bridge Construction
941228-01	Livingston -- Act of Cash Sale (Draft)
941228-02	Livingston -- Lease Agreement (Draft)
941228-03	Livingston -- Environmental Assessment (Draft Final, One Copy) Finding of No Significant Impact (Appendix B)
941228-04	Livingston -- Section 404 Permit
941228-07	Livingston -- Staking Survey
941228-08	Livingston -- Drainage Plan with Hydrologic and Hydraulic Report
941228-10	Livingston -- Conceptual Designs for Pipeline Crossings of the LIGO Embankment
950112-04	Livingston -- Lease Agreement
950112-05	Livingston -- Geotechnical Investigation, Final Report

Appendix A

Abbreviations

Abbreviation	Meaning
A	Ampere
AABC	Associated Air Balancing Council
AASHTO	American Association of State Highway and Transportation Officials
ABS	Acrylonitrile - Butadiene - Styrene
A/C	Air Conditioning
ACCA	Air Conditioning Contractors of America
Ach/hr	Air Changes per hour
ACI	American Concrete Institute
ADA	Americans with Disabilities Act
ADC	Air Diffuser Council
A-E	Architect - Engineer
AECS	Automated Entry Control System
AEIC	Association of Edison Illuminating Companies
AFBMA	ANSI/Fan Bearing Manufacturers Association
AFF	Above Finished Floors
AISC	American Institute of Steel Construction
AMCA	Air Moving and Conditioning Association
AMP	Ampere
ANSI	American National Standards Institute
ARI	Air-Conditioning and Refrigeration Institute
ASCE	American Society of Civil Engineers
ASHRAE	American Society of Heating, Refrigerating and Air-Conditioning Engineers
ASME	American Society of Mechanical Engineers
ASPE	American Society of Plumbing Engineers
ASSE	American Society of Structural Engineers
ASTM	American Society of Testing Materials
AWG	American Wire Gauge
AWS	American Weld Society
AWWA	American Water Works Association
BSC	Beam Splitter Chamber
BHMA	Builders Hardware Manufacturers Association
BTE	Beam Tube Enclosure
°C	Degrees Centigrade
CAGI	Compressed Air and Gas Institute
CBR	California Bearing Ratio
CCR	Clothing Change Room

Abbreviation	Meaning
CCTV	Closed Circuit Television
CDS	Control and Data System (Detector System)
CECER-EM	Corps of Engineers Civil Engineering Regulation - Engineering Maintenance
CERCLA	Comprehensive Environmental Response, Compensation, and Liability Act
CFC	Chlorofluorocarbon
cfm	Cubic feet per minute
CFR	Code of Federal Regulations
CGA	Compressed Gas Association
Ch	Chapter
CISCA	Ceilings and Interior Systems Construction Association
cm	Centimeters
CMAA	Crane Manufacturers Association of America
CRI	Color Rendering Index
CS	Communication System
CTI	Cooling Tower Institute
dB	Decibel
DC/dc	Direct Current
DDC	Direct Digital Control
DDCP	Direct Digital Control Panel
DHHR	Department of Health and Human Resources
DL	Dead Load
DOE	Department of Energy
DOP	Diocetylphalate
DOT	Department of Transportation
E	Seismic Load
EA	Environmental Assessment
EER	Electrical Equipment Room
EES	Earth Electrode Subsystem
EMC	Electromagnetic Compatibility
EMCS	Energy Management Control System
EMI	Electromagnetic Interference
EMT	Electric Metallic Tubing
EPA	Environmental Protection Agency
EPR	Ethylene Propylene Rubber
ESR	Equipment Storage Room
ESS	Electronic Security System
ETL	Engineering Technical Letter
EX	Exceptions

Abbreviation	Meaning
°F	Degrees Fahrenheit
FACP	Fire Alarm and Control Panel
fc	Foot-candles
FCC	Federal Communications Commission
FMCS	Facility Monitoring and Control System
FDC	Facility Design Criteria
FED-STD	Federal Standard
FEMA	Federal Emergency Management Agency
FIP	Field Interface Panels
FM	Factory Mutual
FMEC	Factory Mutual Engineering Corporation
°F _{db}	Degrees Fahrenheit-dry bulb
fpm	Feet per Minute
ft	Foot
FTM	Federal Test Manual
°F _{wb}	Degrees Fahrenheit-wet bulb
g	Gravity Constant (Earth)
GFE	Government Furnished Equipment
GHe	Gaseous Helium
GHz	Gigahertz
GN ₂	Gaseous Nitrogen
gpm	Gallons per Minute
gr/lbda	Grams per Pound Dry Air
HAM	Horizontal Access Module
HEPA	High Efficiency Particulate Air
Hg	Mercury
hr	Hours
HVAC	Heating, Ventilation, and Air Conditioning
Hz	Hertz
ICEA	Insulated Cable Engineering Association
ICBO	International Conference of Building Officials
IEEE	Institute of Electrical and Electronics Engineers
IES	Illuminating Engineering Society
IES	Institute of Environmental Science
in	Inches
I & C	Instrumentation and Controls
ISA	Instrument Society of America
KHz	Kilo-hertz
km	Kilometers
kV	Kilo-volt

Abbreviation	Meaning
kVA	Kilo-volt-Ampere
LCC	Life Cycle Cost
LDEQ	Louisiana Department of Environmental Quality
LIGO	Laser Interferometer Gravitational-Wave Observatory
LL	Live Load
LN ₂	Liquid Nitrogen
LPS	Low Pressure Sodium
LSU	Louisiana State University
LVEA	Laser and Vacuum Equipment Area
Mdl	Model
MER	Mechanical Equipment Room
mg/ft ³	Milligram per cubic foot
mm	Millimeter
MPH	Miles per Hour
NACE	National Association of Corrosion Engineers
NACSEM	National COMSEC/EMSEC Information Memorandum
NACSIM	National COMSEC Information Memorandum
NAPHCC	National Association of Plumbing, Heating and Cooling Contractors
NBS	National Bureau of Standards
NEBB	National Environmental Balance Bureau
NEC	National Electrical Code
NEMA	National Electrical Manufacturers Association
NESC	National Electrical Safety Code
NFC	National Fire Code
NFPA	National Fire Protection Association
NIBS	National Institute of Building Sciences
NIC	Not in Contract
NIOSH	National Institute for Occupational Safety and Health
NIST	National Institute of Standards and Technology
NLSC	National Life Safety Code
NPC	National Plumbing Code
NSF	National Science Foundation
O&M	Operations and Maintenance
OSB	Operations Support Building
OSHA	Occupational Safety and Health Act
OSR	Operations Support Room
ppm	Parts per million
ppmv	Parts per million by volume
PSD	Power Spectral Density
psf	Pounds per Square Foot

Abbreviation	Meaning
psi	Pounds per Square Inch
psig	Pounds per Square Inch Gage
PVC	Polyvinyl Chloride
QA	Quality Assurance
QC	Quality Control
RCRA	Resource Conservation and Recovery Act
RF	Radio Frequency
RFI	Radio Frequency Interference
RH	Relative Humidity
RPIE	Real Property Installed Equipment
RPM	Revolutions per Minute
SBC	Standard Building Code
SBCCI	Southern Building Code Congress International
SCFM	Standard Cubic Feet per Minute
sf	Square Feet
SJI	Steel Joist Institute
SMACNA	Sheet Metal Air Conditioning National Association
SSC	Systems Security Contractor
SSPC	Steel Structures Painting Council
STC	Sound Transmission Class
TAB	Testing and Balance
TBD	To Be Determined
TBR	To Be Revised
THD	Total Harmonic Distortion
TMC	Test Mass Chamber
TVSS	Transient Voltage Surge Suppressor
UBC	Uniform Building Code
UFC	Uniform Fire Code
UL	Underwriters Laboratory
UMC	Uniform Mechanical Code
UON	Unless Otherwise Noted
UPC	Uniform Plumbing Code
UPS	Uninterruptible Power System/Supply
UST	Underground Storage Tanks
V	Volts
VAC	Volts Alternating Current
VAV	Variable Air Volume
VEA	Vacuum Equipment Area
VOC	Volatile Organic Compounds
Vol	Volume

Abbreviation	Meaning
WISHA	Washington Institute of Safety and Health Administration
WL	Wind Load
w.c.	Water Column
w.g.	Water Gauge

