



Keita KAWABE, LIGO Hanford Observatory/Caltech
for the LIGO Scientific Collaboration

- Who we are
 - Introduction to LIGO and LSC
- Where we are at now
 - Status of Current Science Run (S5)
 - Detector Performance etc.
- Future



Who We Are



- Laser Interferometer Gravitational-Wave Observatory
- Funding: NSF
- Operation: Caltech-MIT
- 2 observatories, 3 detectors
 - Hanford (LHO), 4km & 2km, (30+ local staffs)
 - Livingston (LLO), 4km, (30+ local staffs)
- CIT/MIT staffs outside of site (more than 100)
- LIGO Scientific Collaboration (LSC), a body carrying out the scientific program of LIGO (about 570 as of now, all over the world)



LIGO Hanford Observatory (LHO)

H1 : 4 km arms

H2 : 2 km arms

Desert in north west, Washington

LIGO Livingston Observatory (LLO)

L1 : 4 km arms

Swamp in gulf coast, Louisiana

3000km, 10 ms



●Adap ted from “The Blue Marble: Land Surface, Ocean Color and Sea Ice” at [visiblearth.nasa.gov](http://visibleearth.nasa.gov)

●NASA Goddard Space Flight Center Image by Reto Stöckli (land surface, shallow water, clouds). Enhancements by Robert Simmon (ocean color, compositing, 3D globes, animation). Data and technical support: MODIS Land Group; MODIS Science Data Support Team; MODIS Atmosphere Group; MODIS Ocean Group. Additional data: USGS EROS Data Center (topography); USGS Terrestrial Remote Sensing Flagstaff Field Center (Antarctica); Defense Meteorological Satellite Program (city lights).

- Compare the travel time of photons in orthogonal directions using laser interferometer

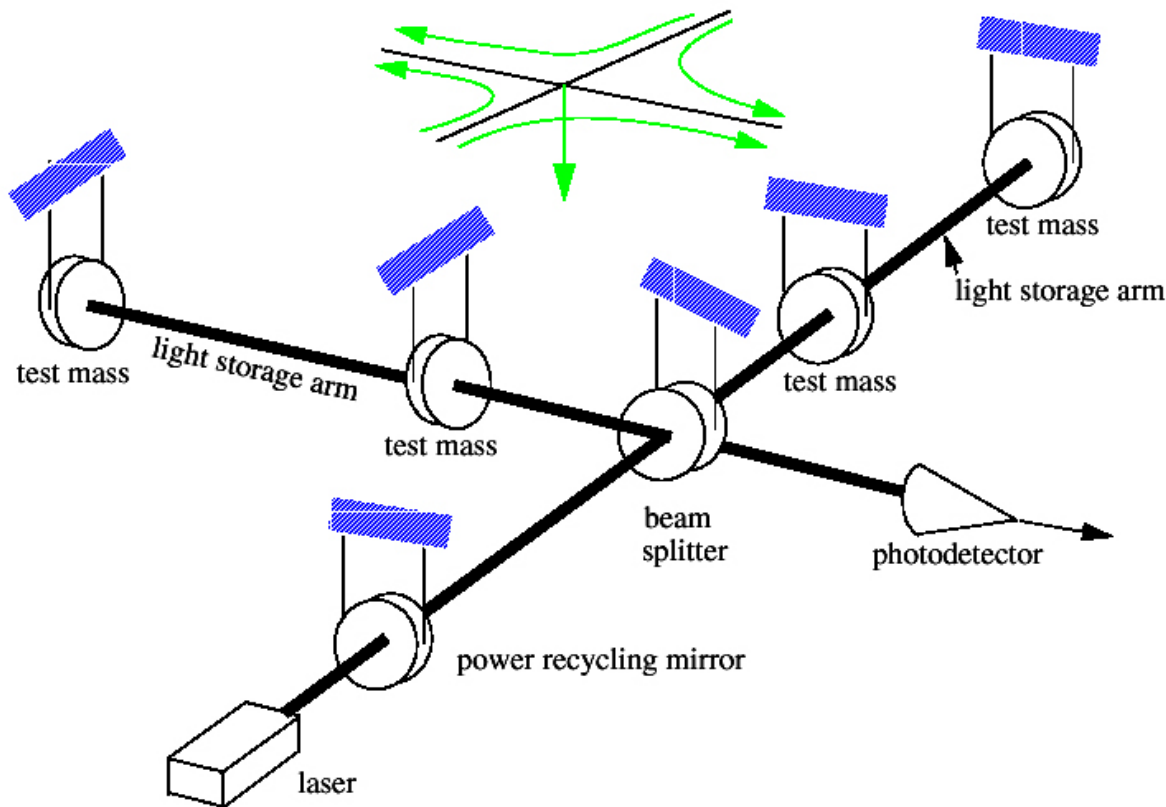

- Power-recycled,
- Michelson IFO,
- Fabry-Perot arms
– 4km (or 2km)

- Substrate: SiO₂
 - 25cm diam x 10cm thick
 - Homogeneity < 5×10^{-7}
 - Internal mode Q factor > 2×10^6
- Polishing
 - Surface uniformity < 1nm rms
 - Radius of curvature matched < 3%
- Coating
 - Scatter < 50ppm
 - Absorption < 2ppm
 - Uniformity < 10^{-3}

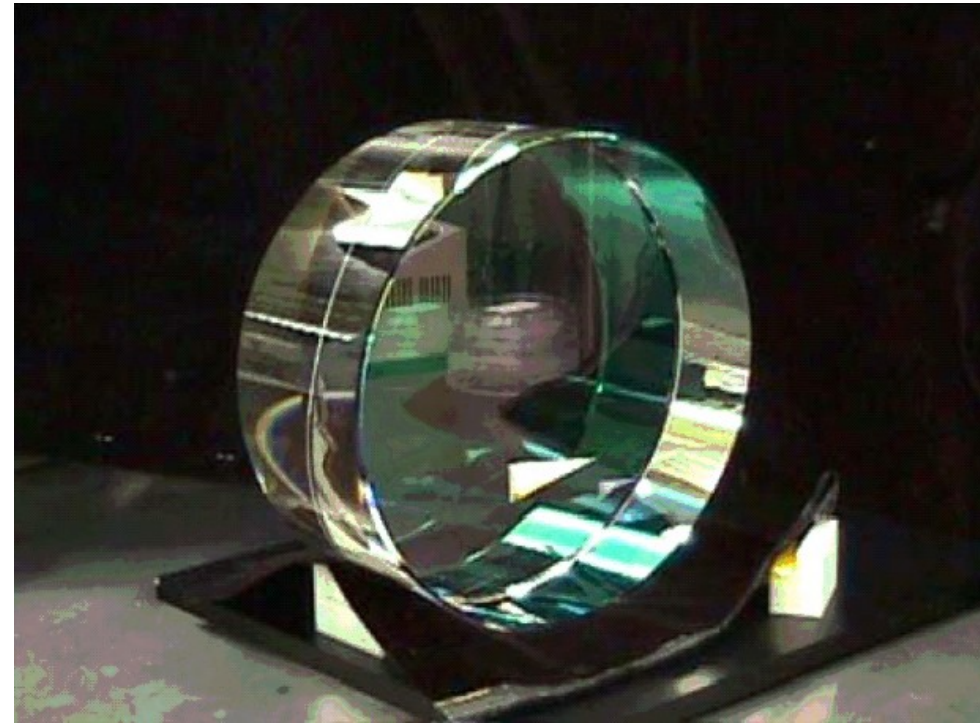

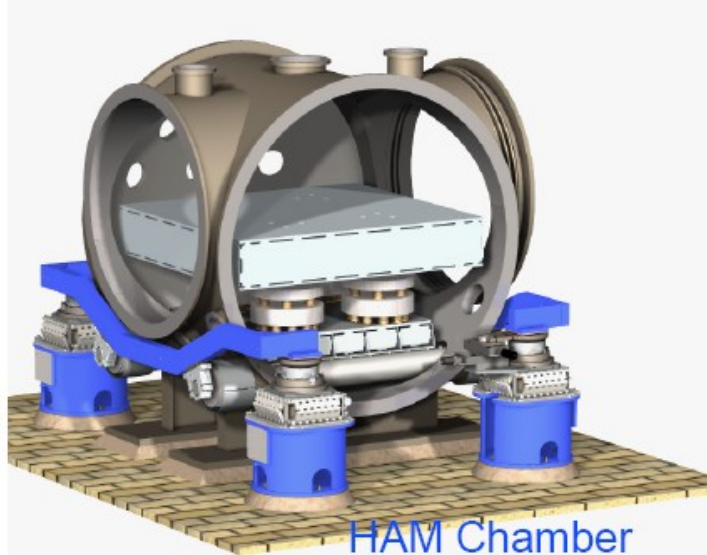

Vibration-isolated chambers using stack

Core Optics Suspension →





Where We Are At Now



- 4 Science Runs (S1-S4) in the past
- S5, starting Nov/04/2005, is still ongoing
 - The last run with the current configuration
 - **At design sensitivity** (or better) for all 3 IFOs
 - Close to the end: **2007/Oct/01 00:00:00 UTC**
 - Will accumulate **one year's** worth of **3-IFO coincidence** by then
 - Coincident run with **GEO** and **VIRGO**
 - Sometimes 5-fold coincidence

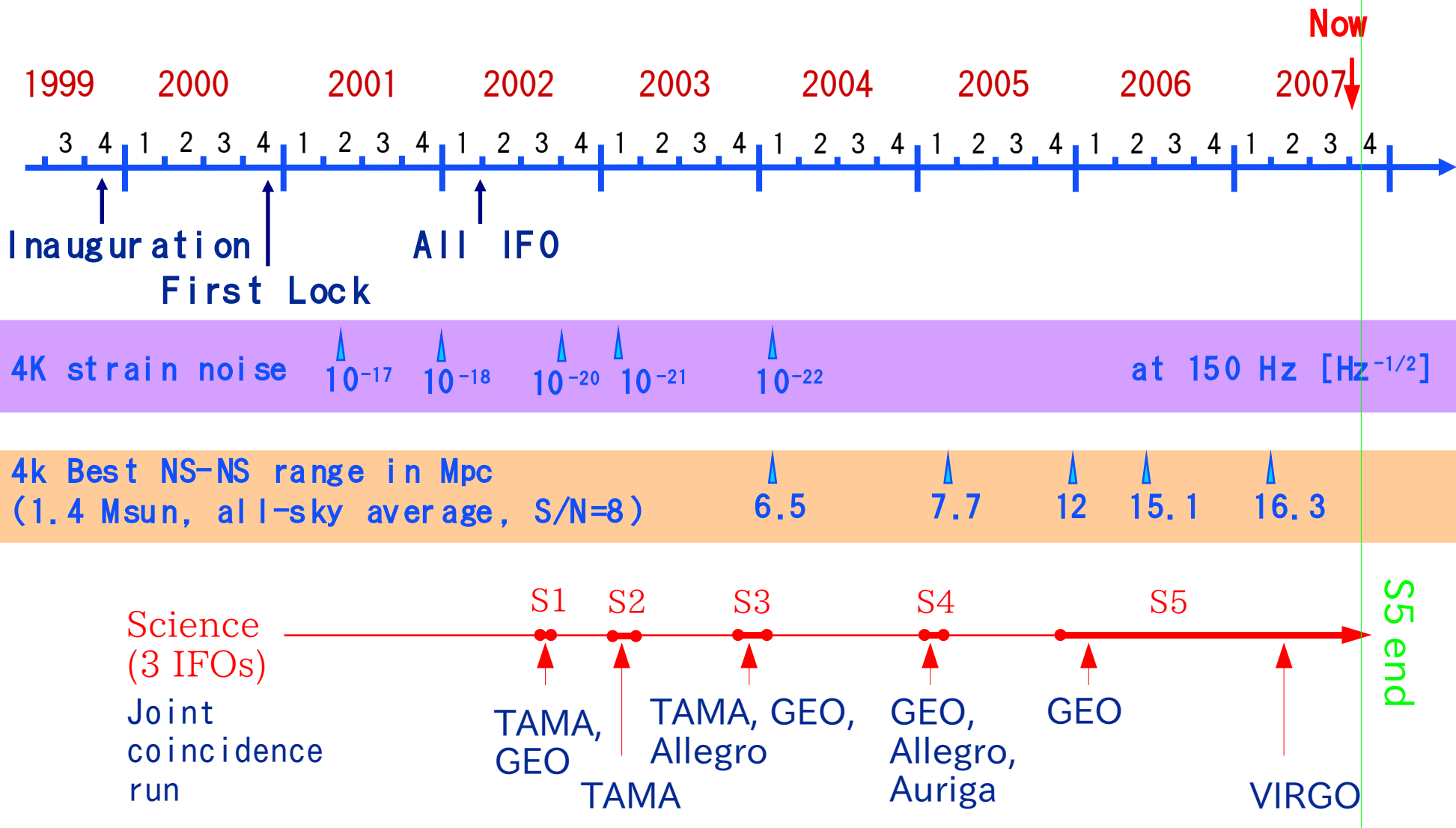

- Shot noise (and radiation pressure noise)
- Thermal motion of mirror and suspension
- Seismic motion
- Gravity gradient
- Residual gas
- Many, many technical noise not shown here
 - Electronics etc.

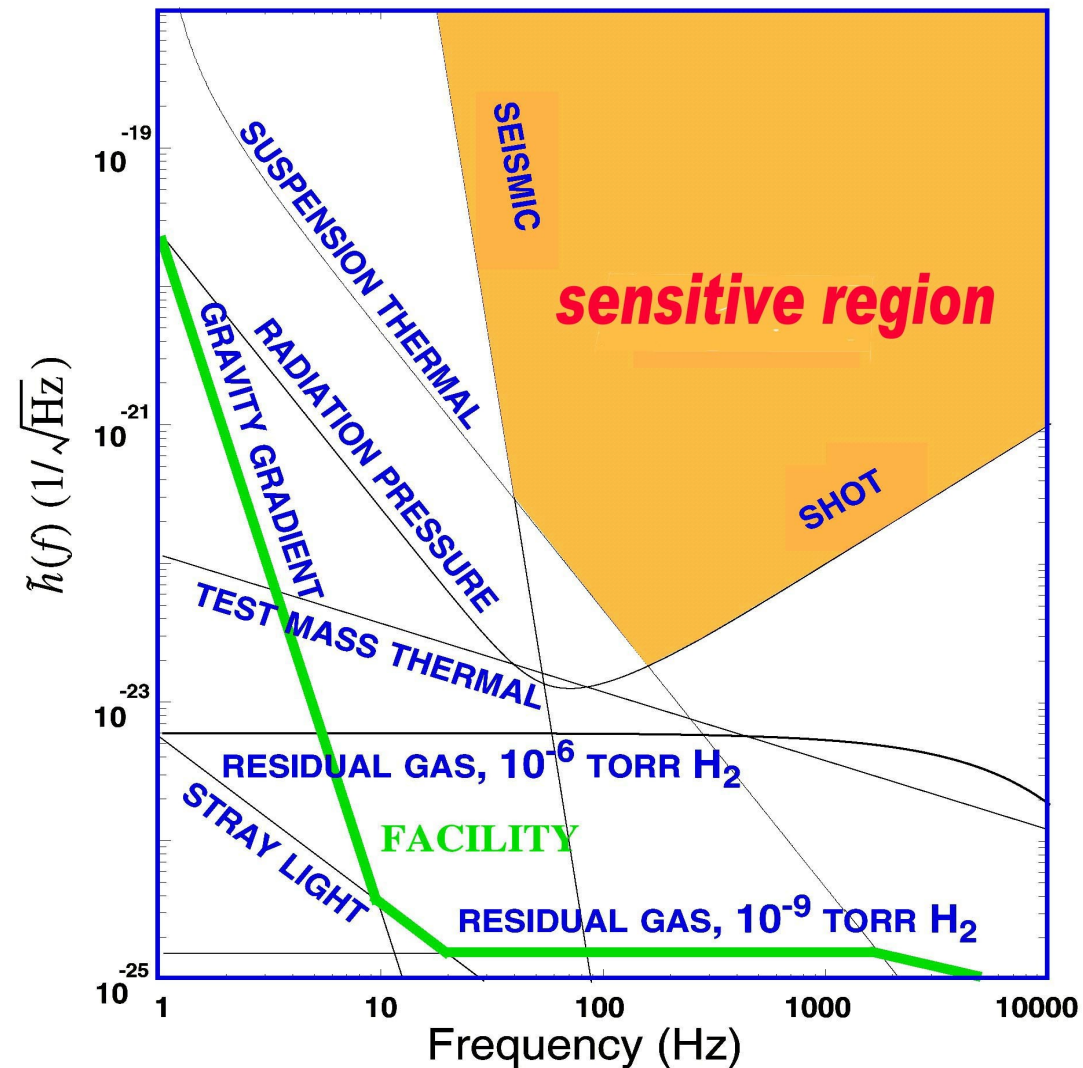

Strain Sensitivity of the LIGO Interferometers

S5 Performance - May 2007

LIGO-G070366-00-E

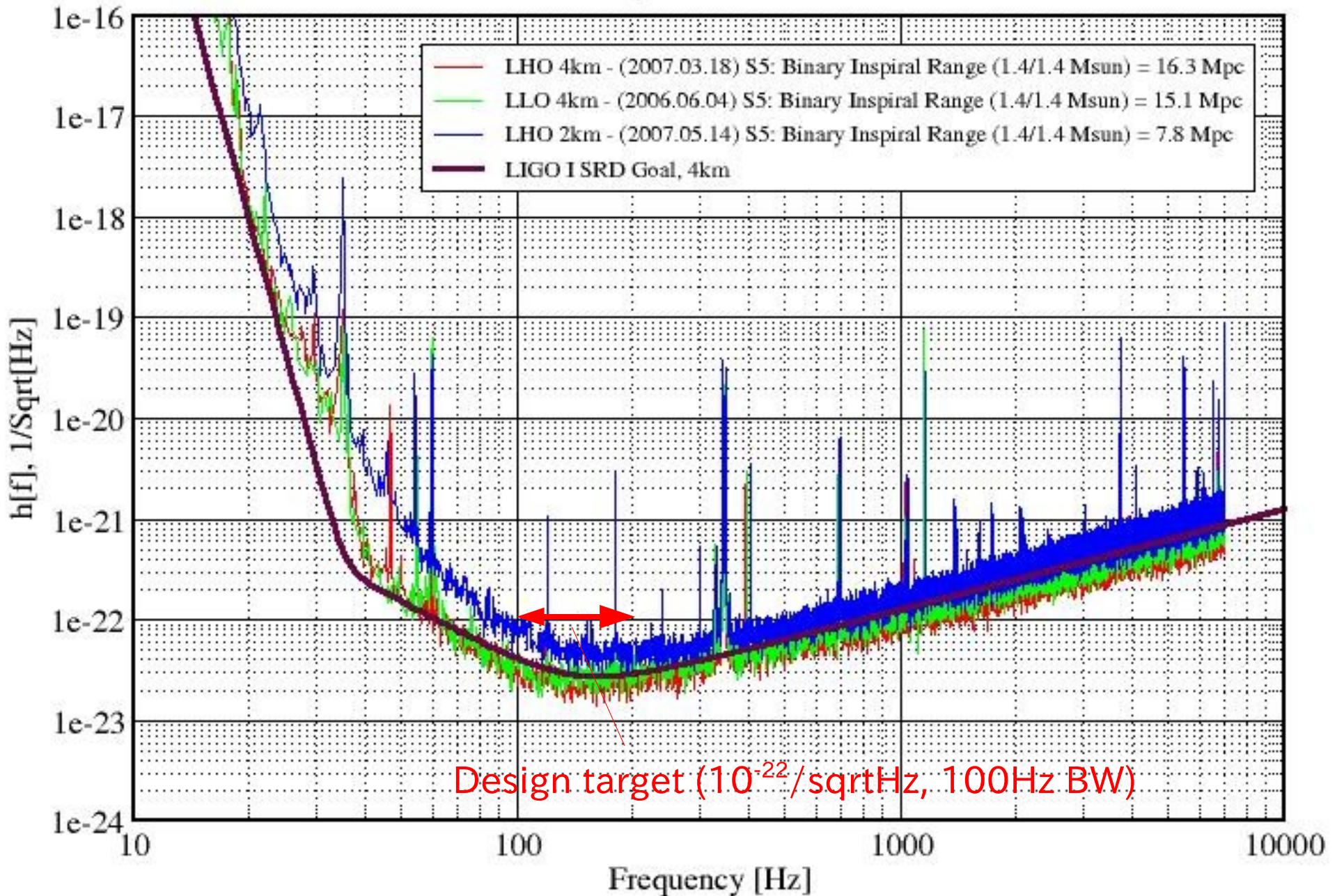

Strain Sensitivity of the LIGO Interferometers

S5 Performance - May 2007

LIGO-G070366-00-E

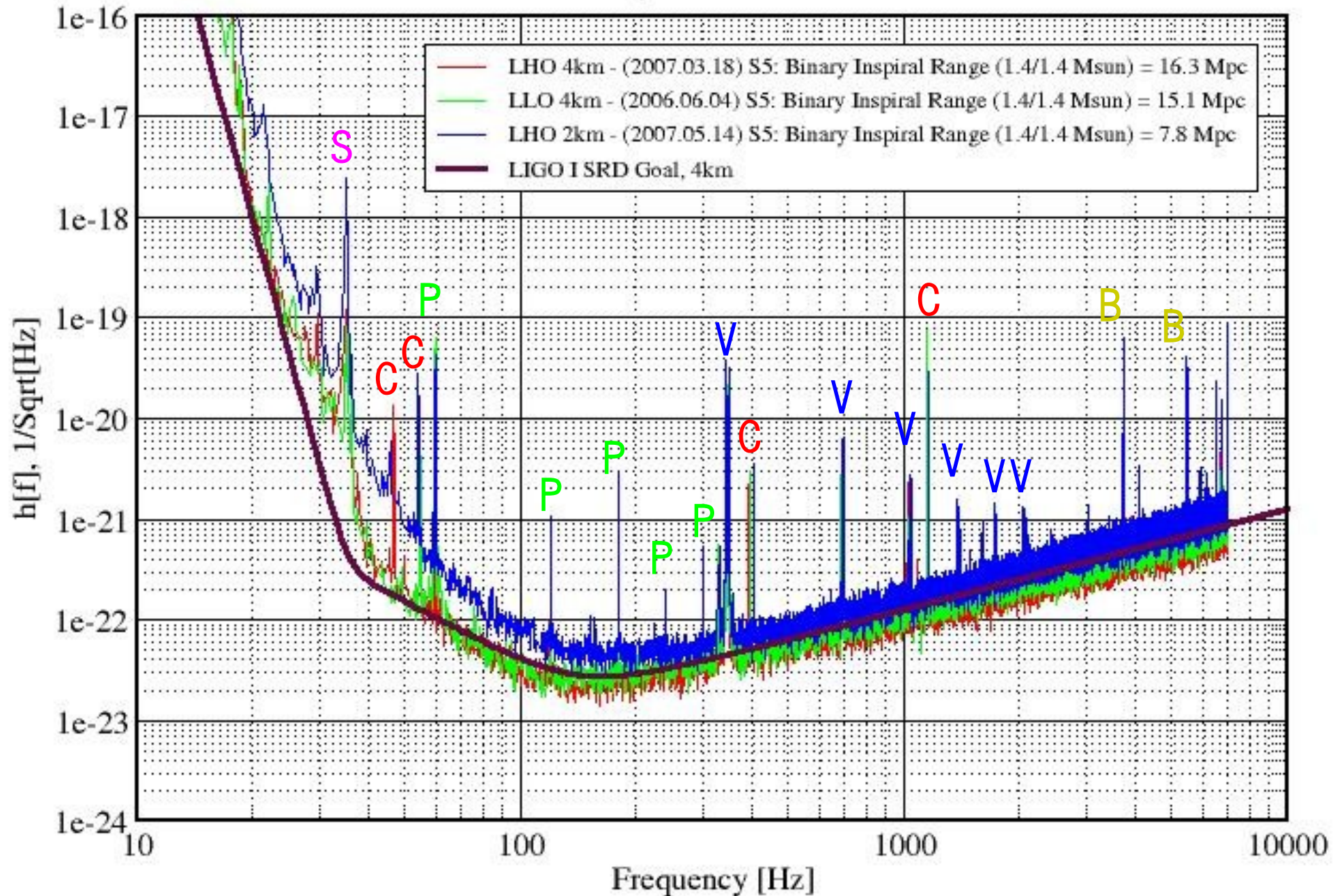

3 IFOs running well: Recent control room screen

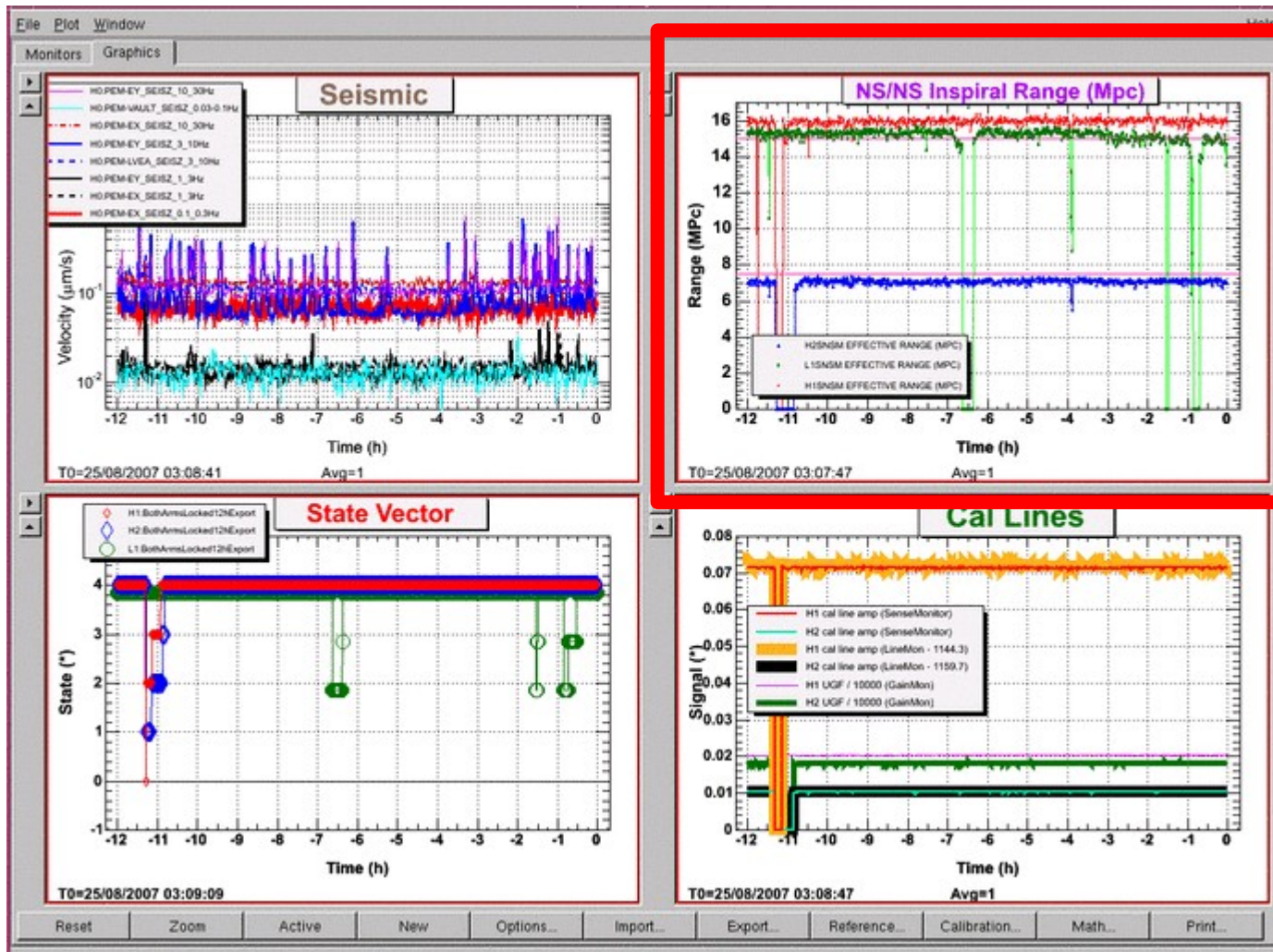

- 12 hr trend of NS-NS inspiral range

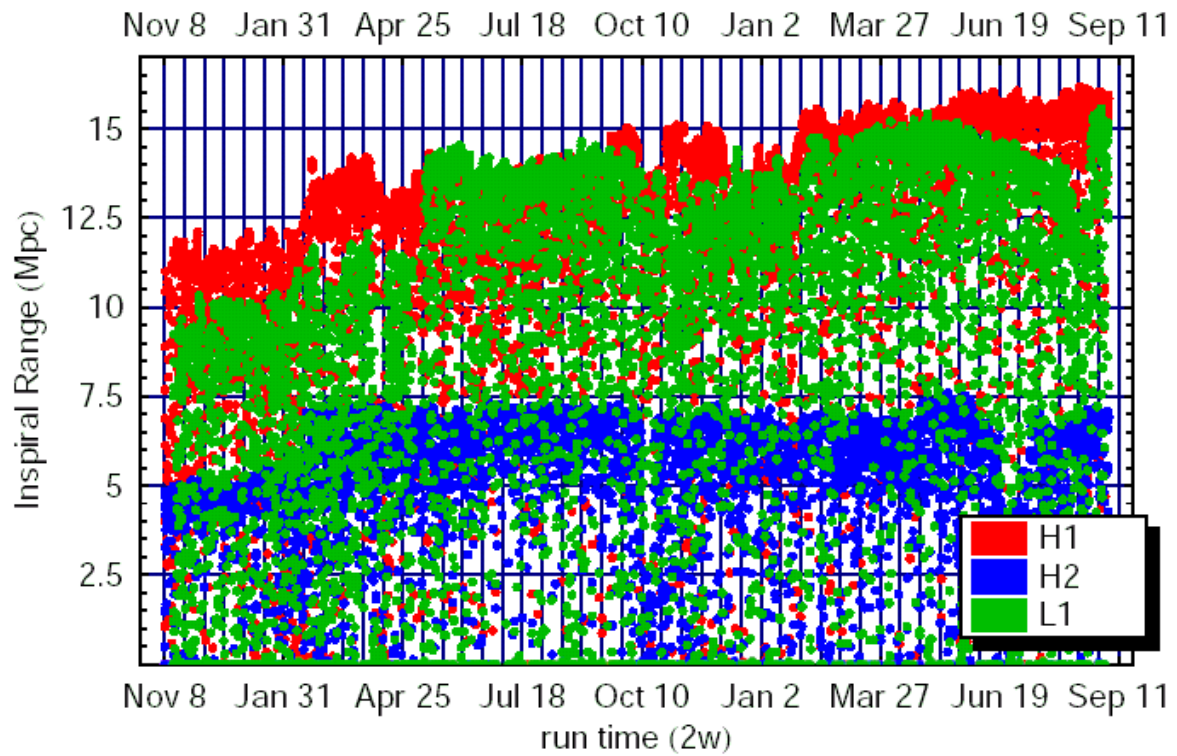

NS-NS binary range
from the start of S5

Duty factor
from the start of S5

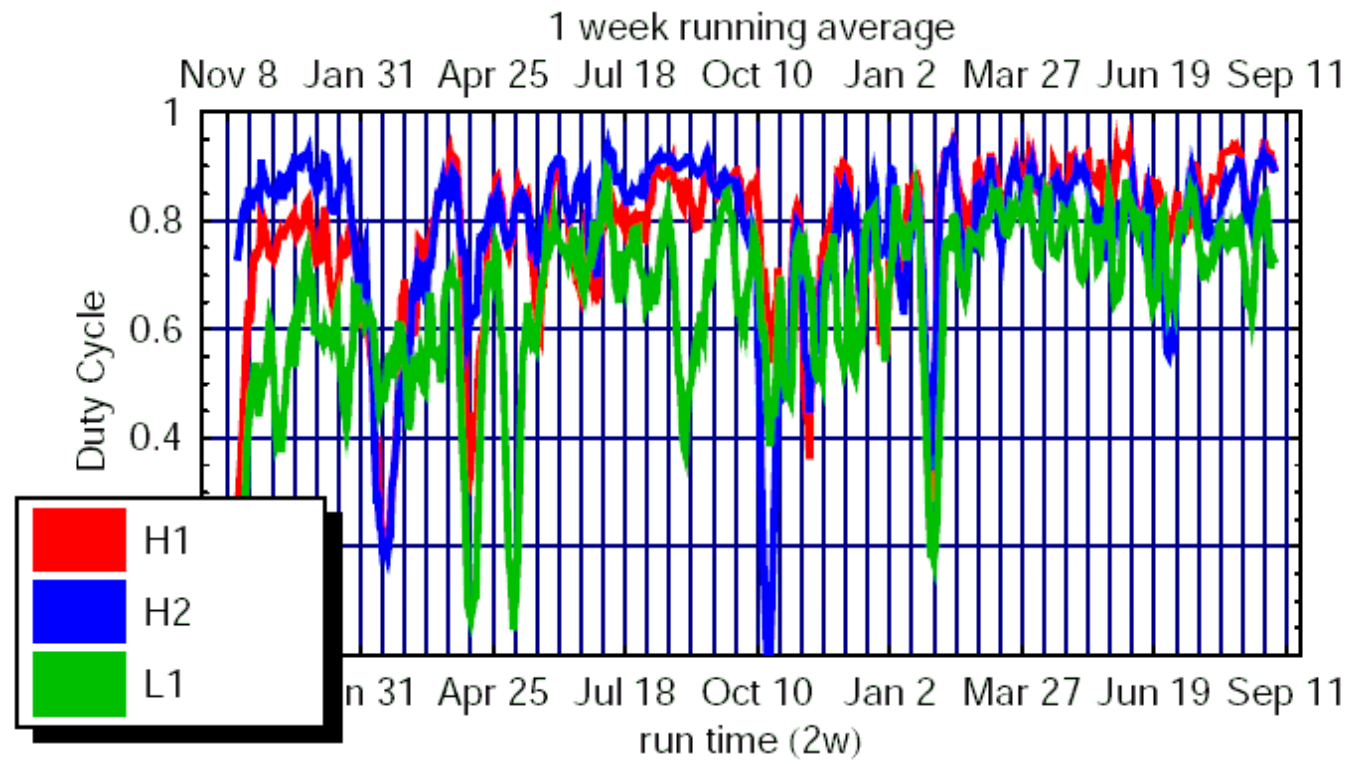

- Periodic sources

- Binary pulsars, spinning NS, low mass X-ray binaries
- Example of upper limits (targeted)
 - $h_0 < 4.8 \times 10^{-26}$ (PSR J1623-2631)
 - $\epsilon < 1.1 \times 10^{-7}$ (PSR J2124-3358)
 - Crab pulsar: *observational GW emission upper limit is smaller than the spin-down derived limit*

- Coalescing compact binaries

- NS-NS, NS-BH, BH-BH
- Physics regimes: Inspiral, merger, ringdown
- Numerical relativity is essential to interpret GW waveform
- ~ 16 Mpc (1.4 - $1.4 M_{\odot}$, all-sky, S/N=8)

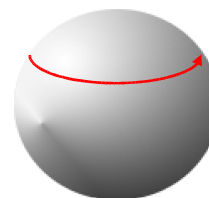

“Mountain” on neutron star



Wobbling neutron star

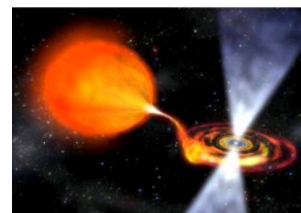

Accreting neutron star

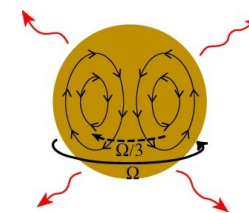

R-modes

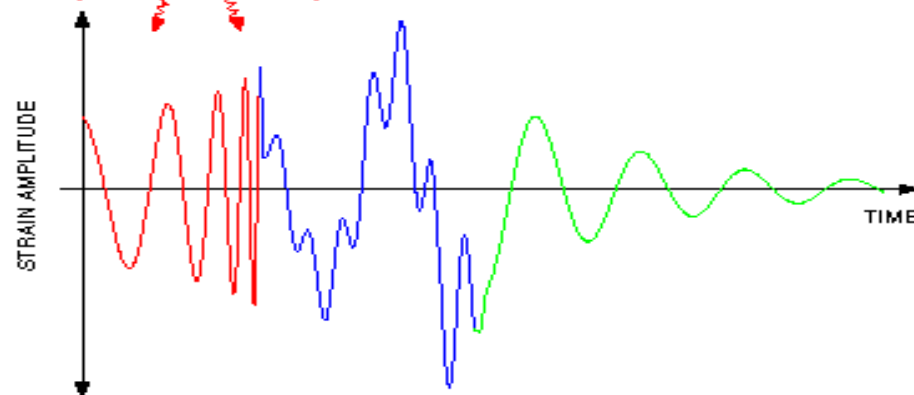
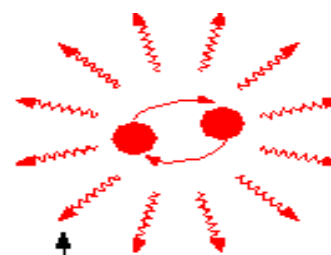

- Burst

- e.g. Supernovae with asymmetric collapse
- Abrupt, uncharacterized impulse.
- Ex) Upper limit:
 - $E_{\text{GW}} \sim 0.1 M_{\odot}$ at 20 MpA (153 Hz case, untriggered)
 - $E_{\text{GW}} \sim 10^{-7}$ to $10^{-8} M_{\odot}$ (SGR1806-20 at 5-10 kPa)

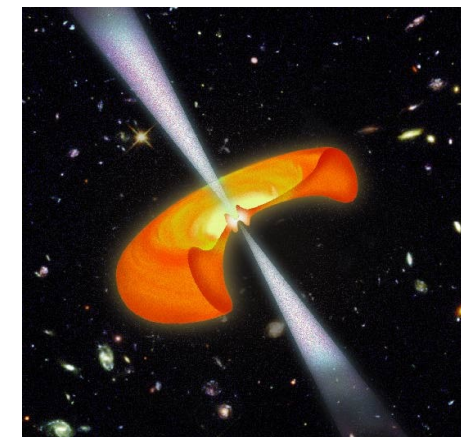
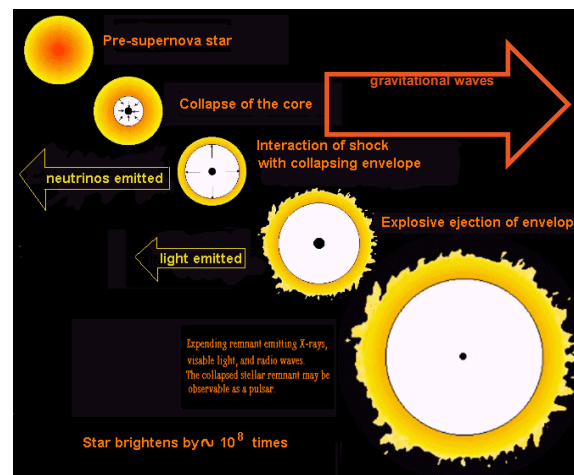

- Stochastic background

- Primordial Big Bang ($t = 10^{-22}$ sec)
- Cross correlation of signals in pairs (LHO-LLO, LHO-LHO)
- Ex.) First upper limit all-sky map of stochastic point source for S4

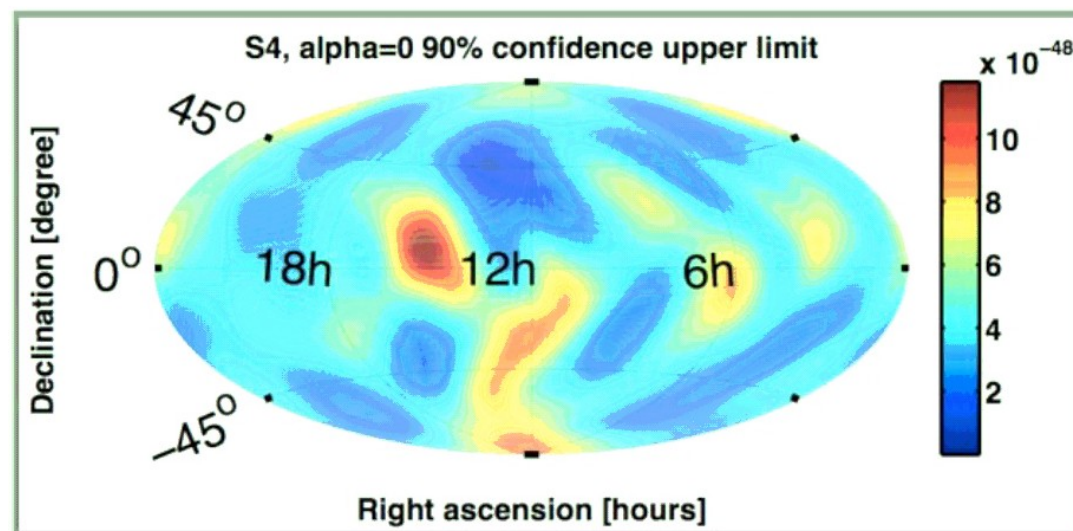

- Knowledge from any other means/channels
 - better GW source model etc.
 - trigger with location information (e.g. GRB/SWIFT) etc.
- GW detection might also impact underlying physics of observed objects
 - e.g. non axi-symmetry and NS equation of state
- NS specialists: please don't leave until the end of this talk (conference ad alert!).

Control room screen for GRB alert

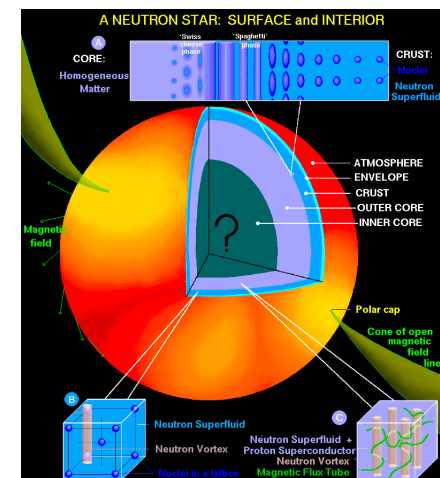
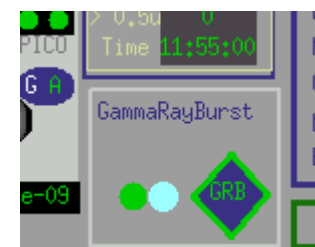

I'm afraid I don't have time to talk about these

- Many observational results for S4 and earlier were already published.
 - Please go to <http://www.ligo.org>
- Some analysis are going on for S4 and S5.
 - Some already appeared in conference talks.
 - Again <http://www.ligo.org>

- Design sensitivity requirement met by all 3 IFOs.
- Good duty factors.
- As of Sep/10/2007, about 97.3 % of 1-year (~355 days) 3-coincidence data has been accumulated.
 - Already more than 1-year 2-site coincidence (accomplished July 2007)
- End of S5 date set: 2007/Oct/01 00:00:00 UTC
 - We'll very likely accumulate more than 1 year worth of 3-coincidence data.
- We'll be ready for the next step very soon!



LIGO Future



- S5, 1yr data, with design sensitivity
 - Hundreds of galaxies in range, detection possible
- Enhanced LIGO
 - Operation in 2009
 - 8 times more galaxies in range, 8 times more detection probability
- Advanced LIGO project (~200M\$)
 - Construction start expected in FY08
 - 1000X more galaxies in range
 - Expect ~1 signal/day- 1/week in ~2014

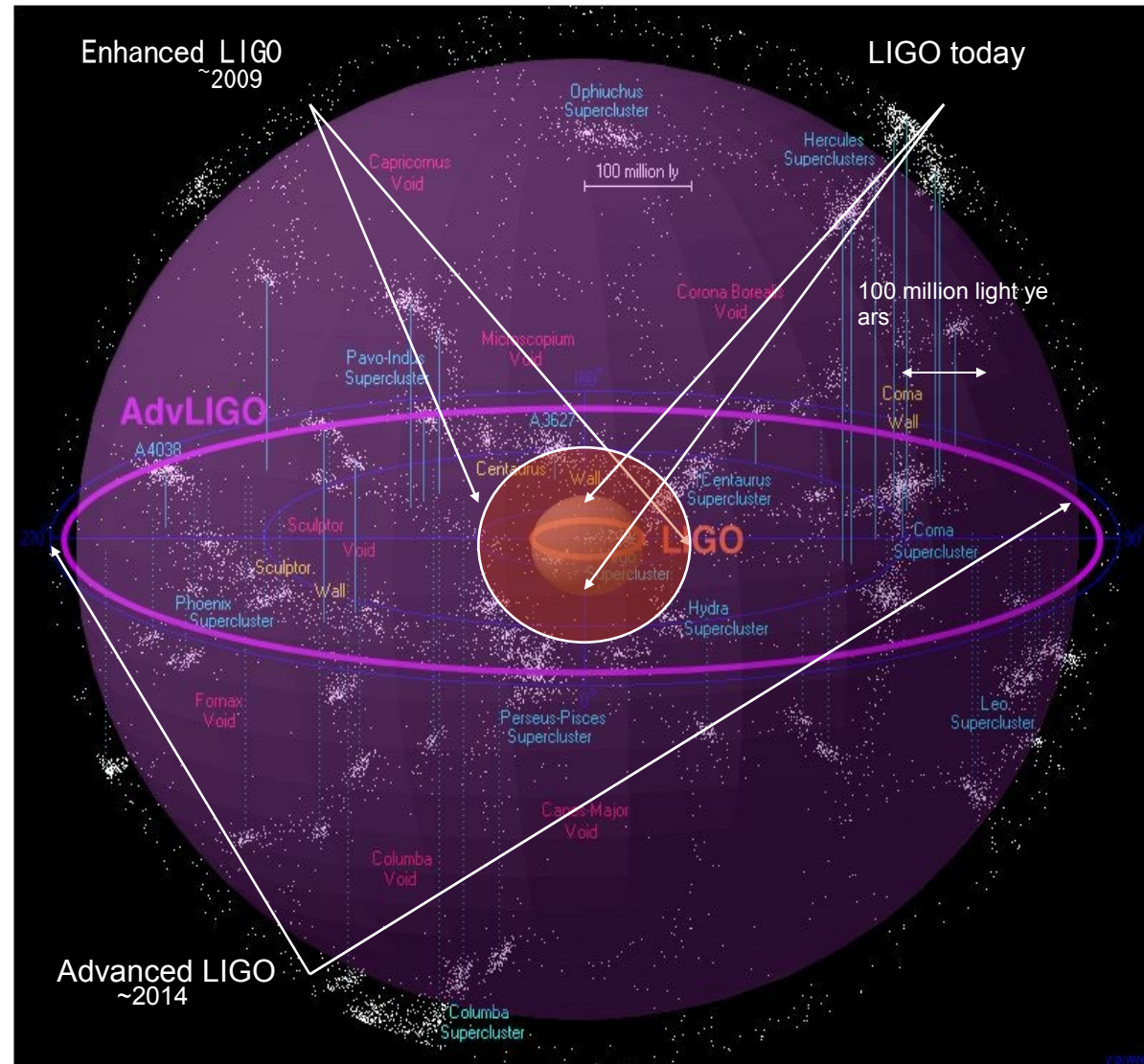

- Realistic, modest upgrade of initial LIGO detectors
- Early commissioning of advanced LIGO technologies
 - One high power laser module, allowing us to inject 30+ W (instead of 7-8 W)
 - DC readout with output mode cleaner
 - Better thermal compensation
- Another ~1-year run, S6, before AdLIGO

DC Readout, 30 W

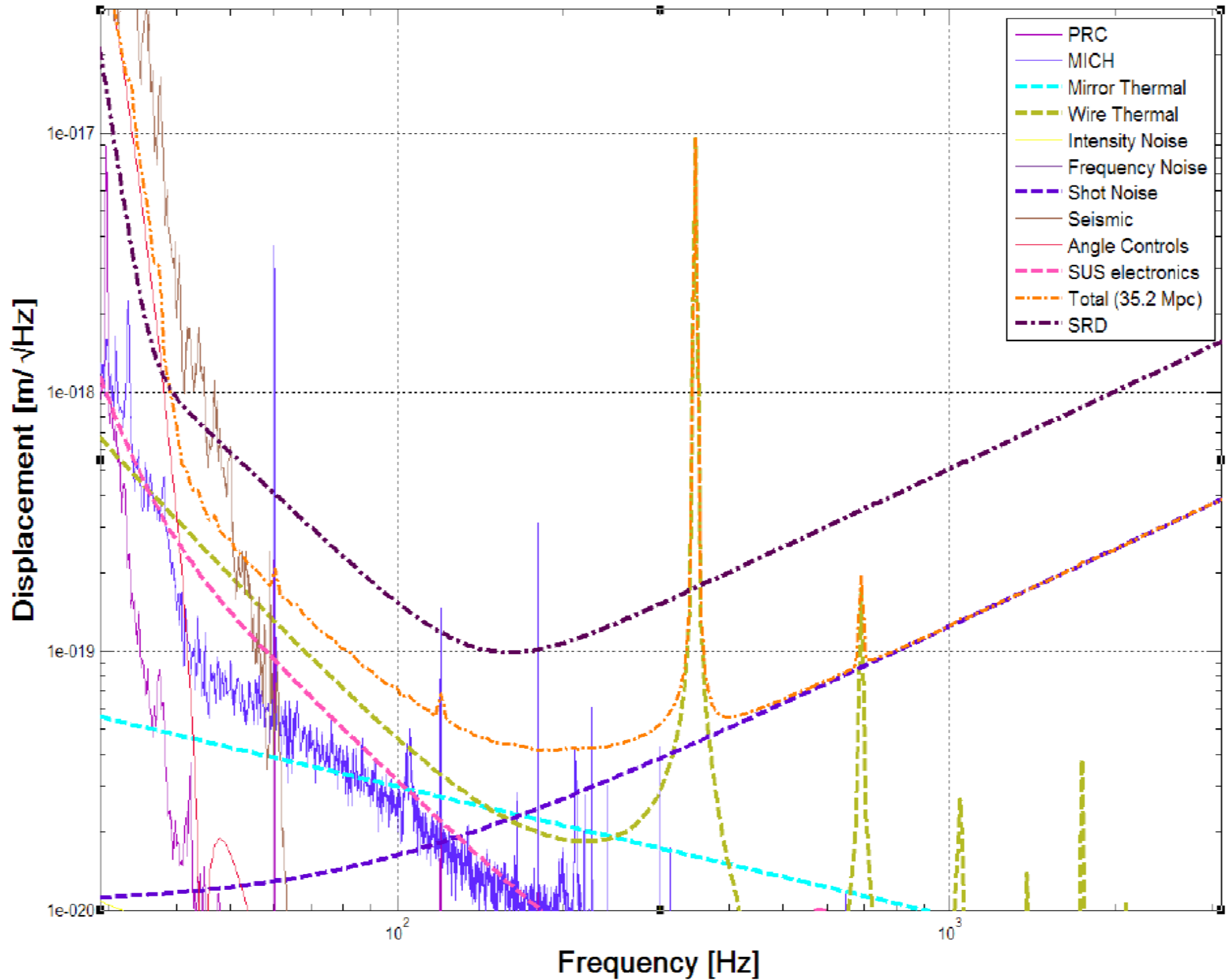

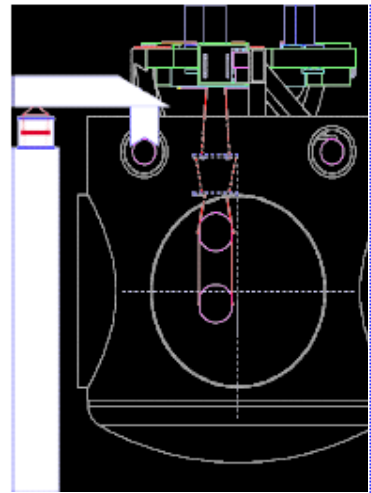

Active vibration isolation systems

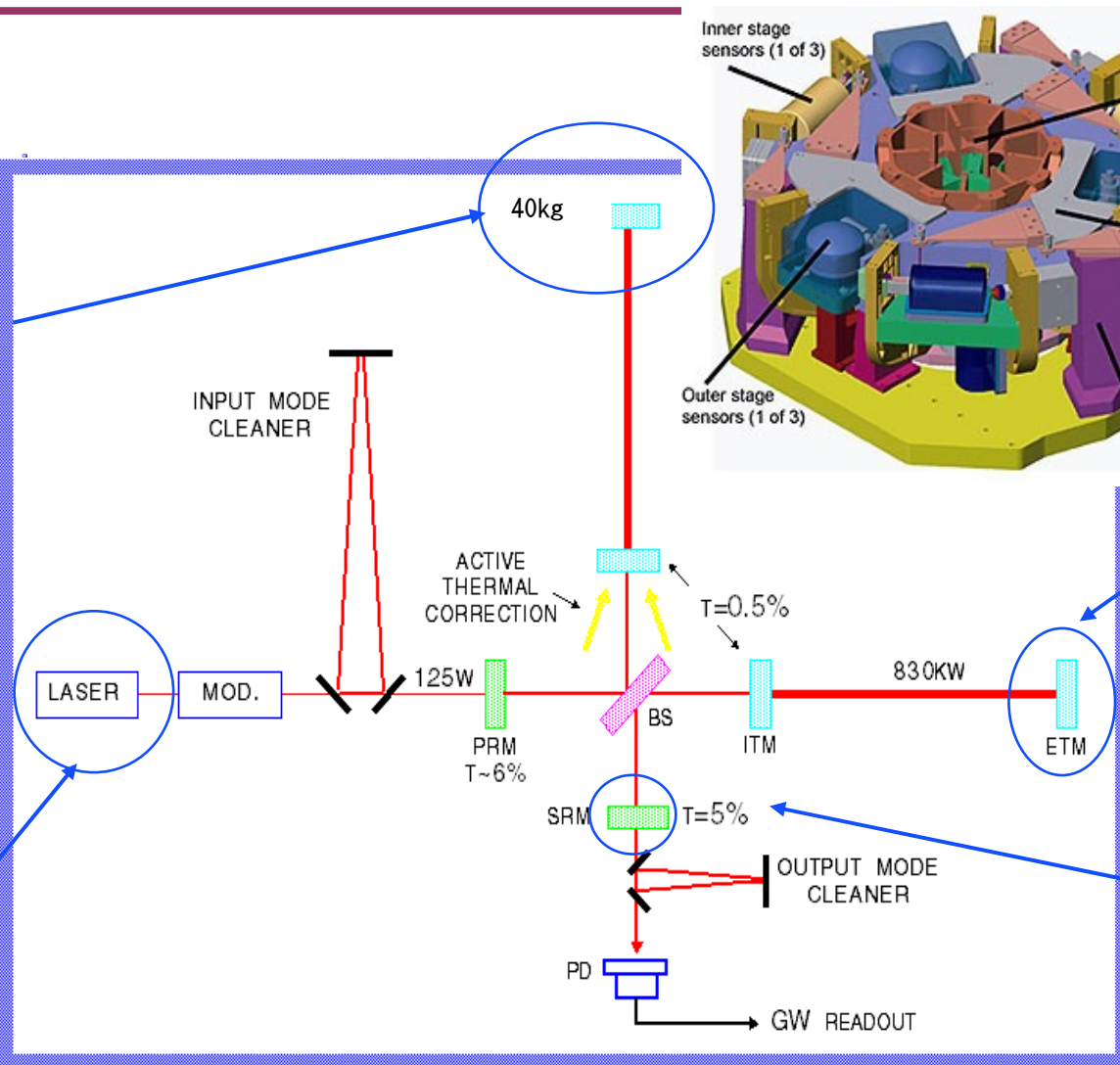

High power laser (180W)

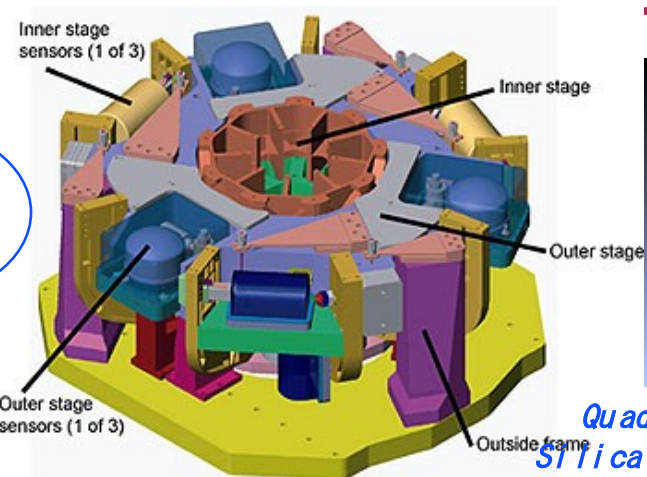

Quadruple pendulum:
Silica optics, welded to silica suspension fibers

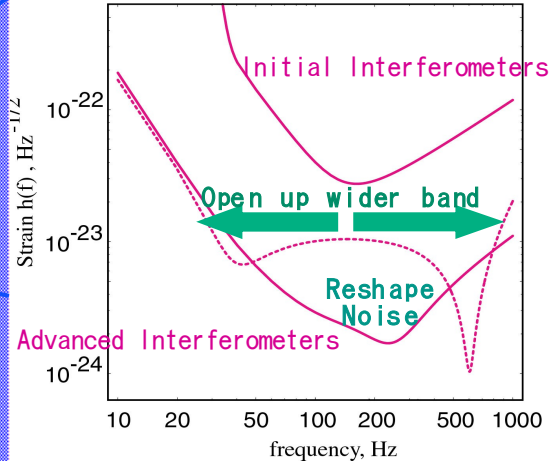
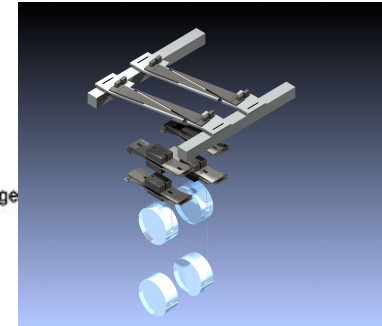

Advanced interferometry
Signal recycling



- Newtonian background, estimate for LIGO sites
- Seismic 'cutoff' at 10 Hz
- Suspension thermal noise
- Test mass thermal noise
- Unified quantum noise dominates at most frequencies for full power, broadband tuning

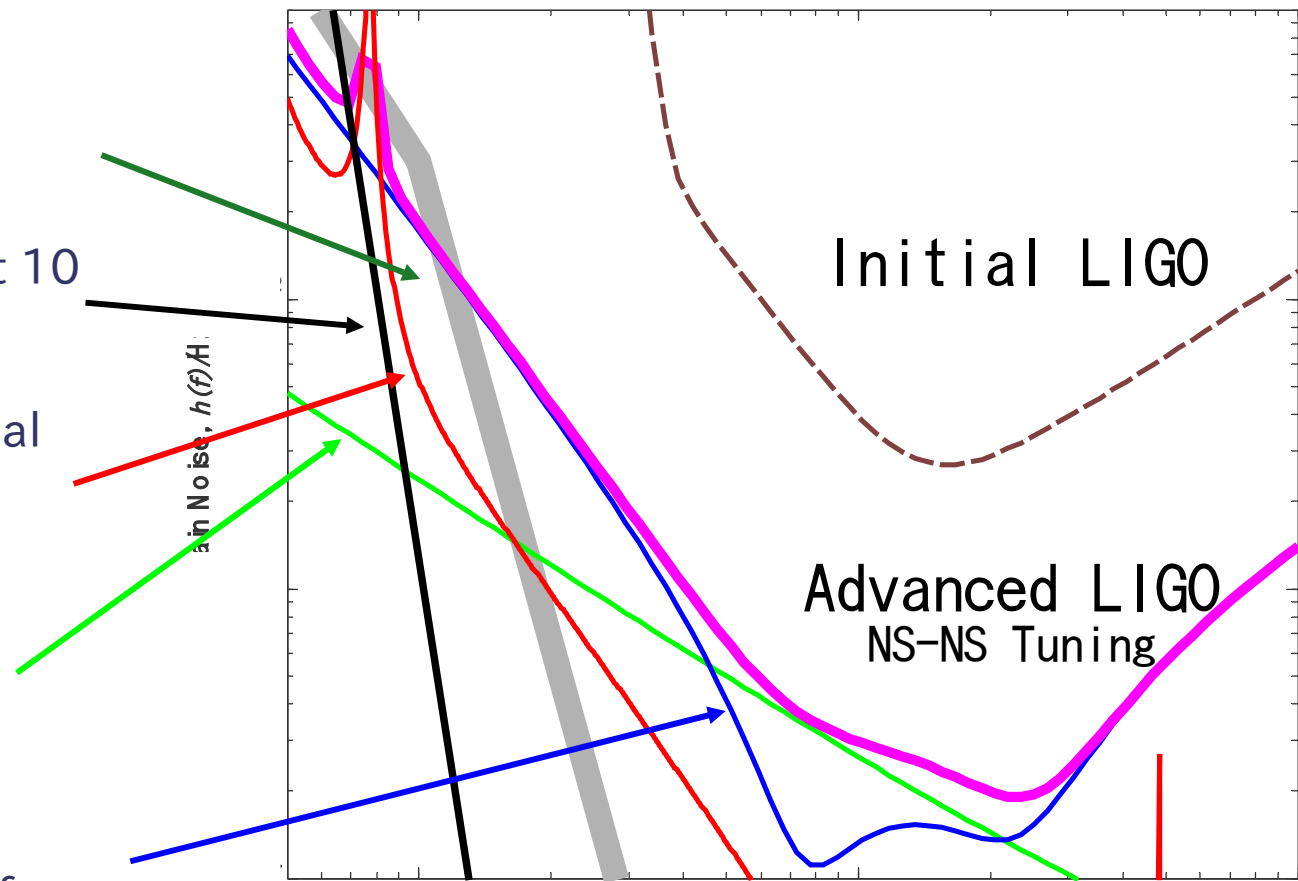

- LIGO is close to an end of S5 run with excellent performance
- Data analyses ongoing
- Ready for the next step
 - LIGO enhancement (operation 2009)
 - Advanced LIGO expected to detect GW on a regular basis (in 2014)



Global Network of GW Detectors in the Future



- GW detection for astronomy
 - Higher detection confidence
 - Better localization of sources
 - Better polarization decomposition of the wave
- All of these necessitates multiple detectors around the world!

Global Network of GW Detectors in the Future

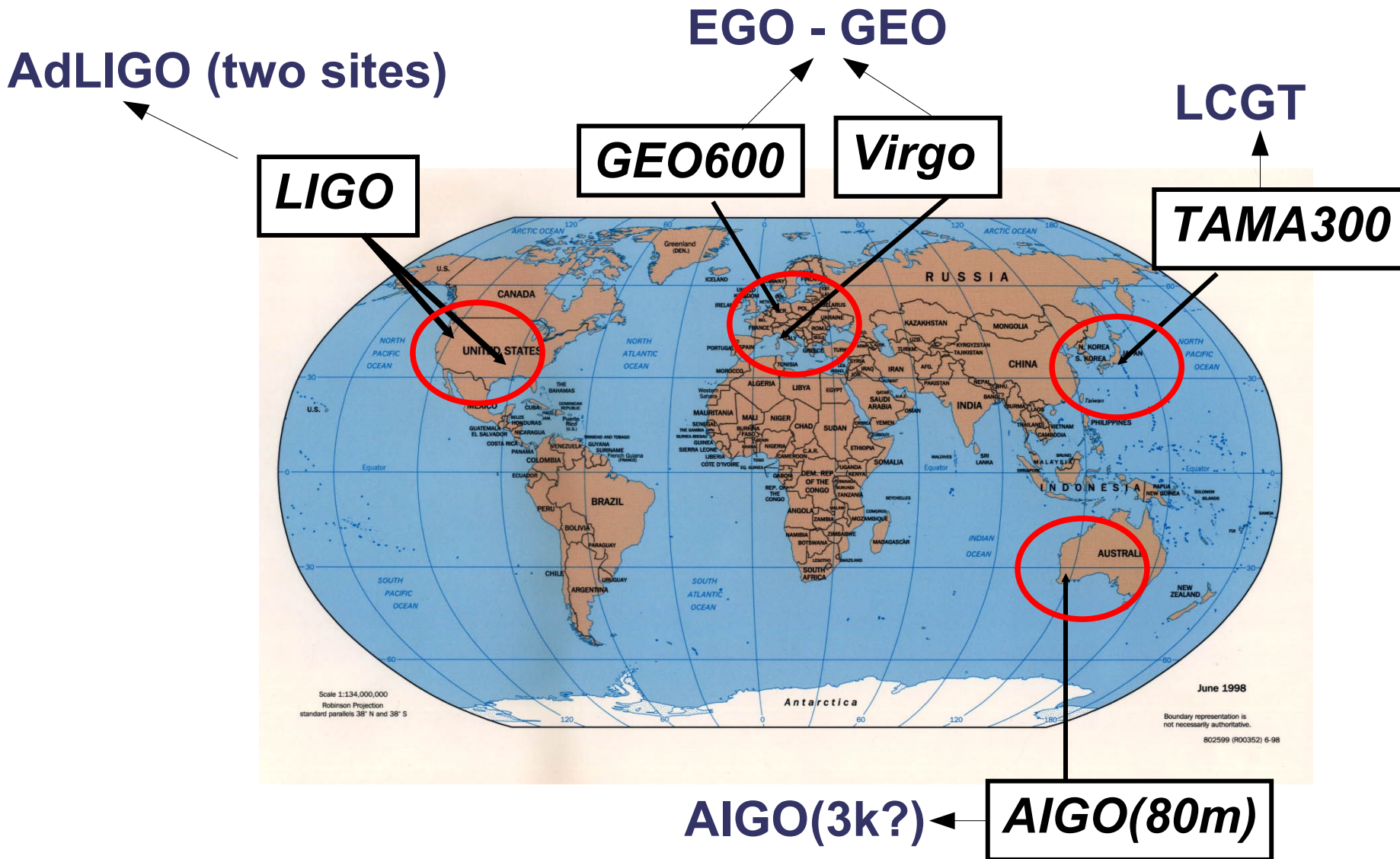

AdLIGO (two sites)

LISA

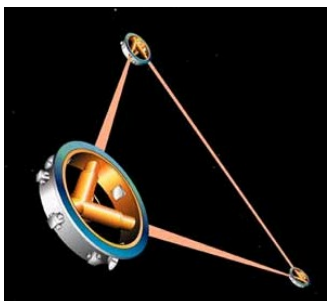

<http://lisa.nasa.gov>
Courtesy NASA/JPL-Caltech

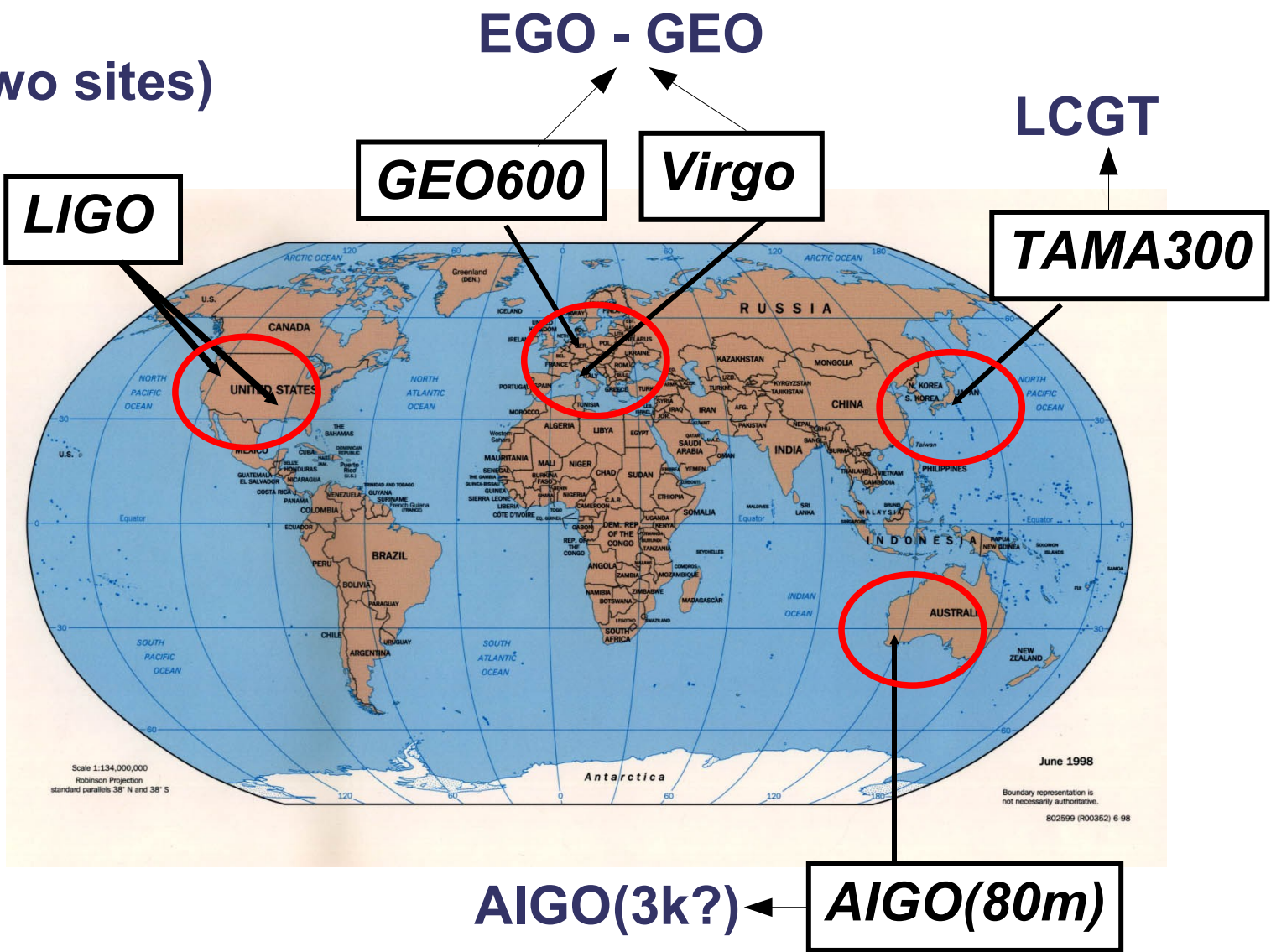

LIGO

GEO600

Virgo

TAMA300

AIGO(80m)

AIGO(3k?)

DECIGO

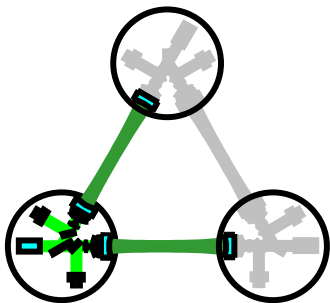

Courtesy S.Kawamura



Advertisement 1: 2nd Annual NS/LSC Meeting



<http://www.ligo-wa.caltech.edu/~mlandry/NSMeet/Oct07/>

- Oct/20/2007, Albert Einstein Institute in Hannover, Germany.
- A meeting between neutron star experts and gravitational wave researchers searching for continuous wave.
- “spin evolution, braking indices, crusts, magnetic fields, population studies, new surveys, and anything else that could affect detectability of gravitational waves.”

Advertisement 2: Pulsar analysis using your PC!

- All-sky pulsar GW search
 - computer intensive, bound by CPU power.
- You can help by taking part in **Einstein@Home!**
- Distributed computing with **SETI@Home** technology.
- Really easy with Windows, Linux and OSX.
- 55000 active users, 70+ TFLOPS
- <http://einstein.phys.uwm.edu/>

Pretty screensaver!

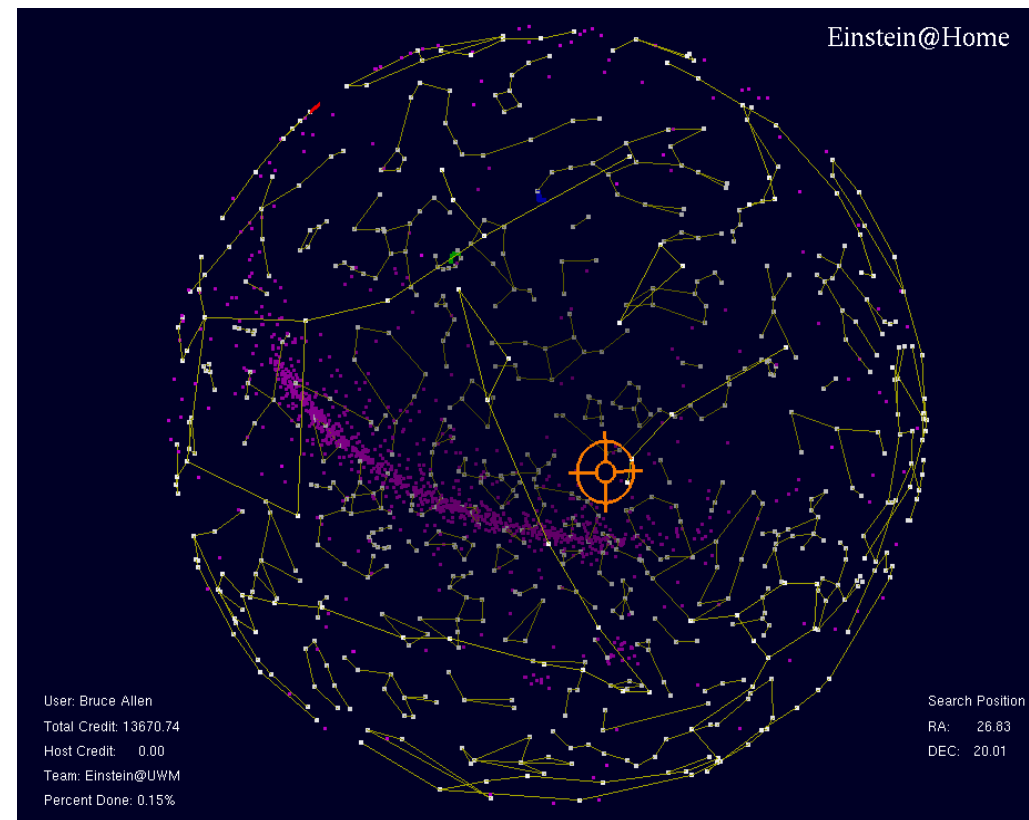



END



HEPI: Hydraulic External Pre-Isolator

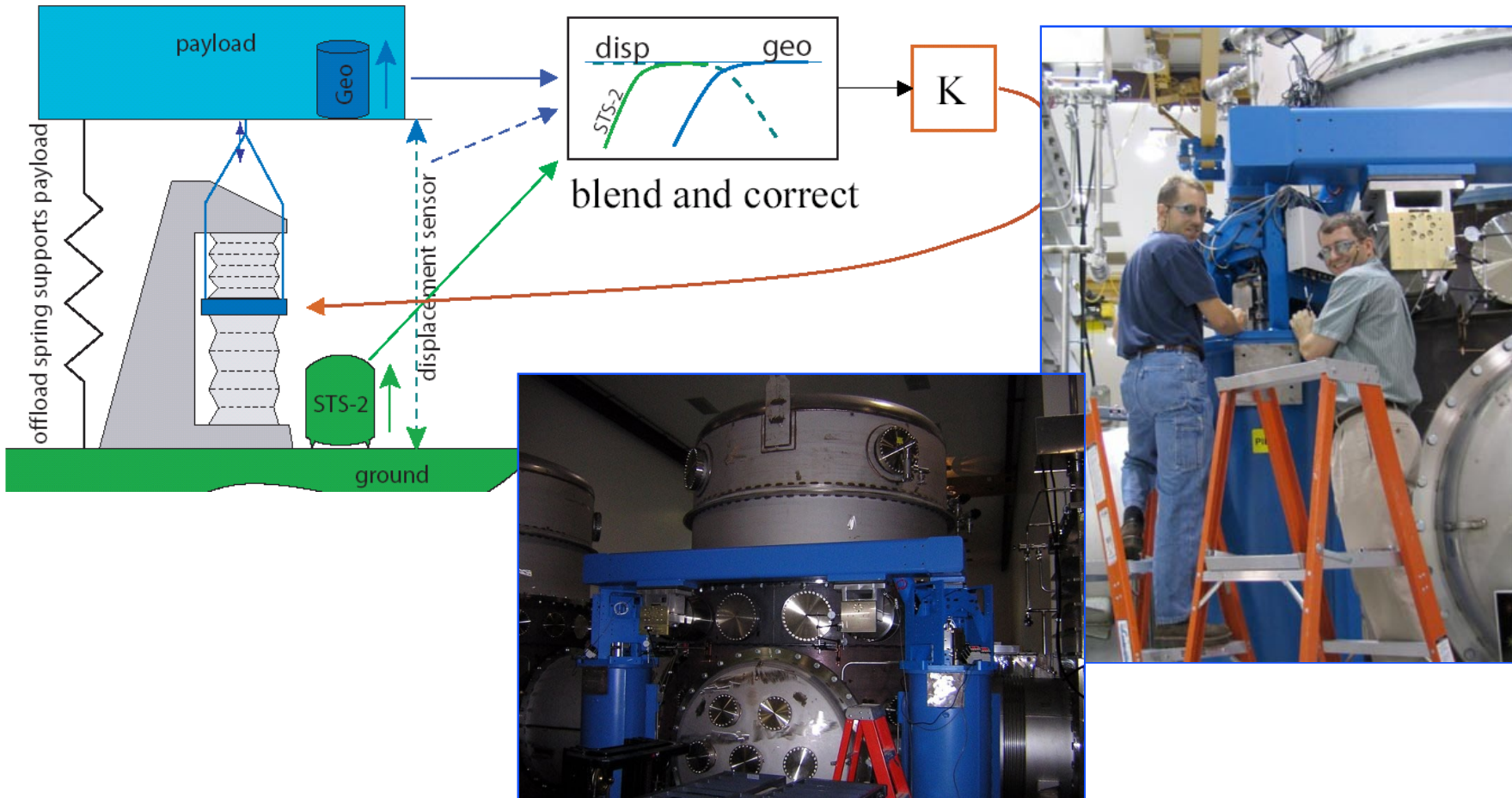

Early implementation of AdLIGO technique

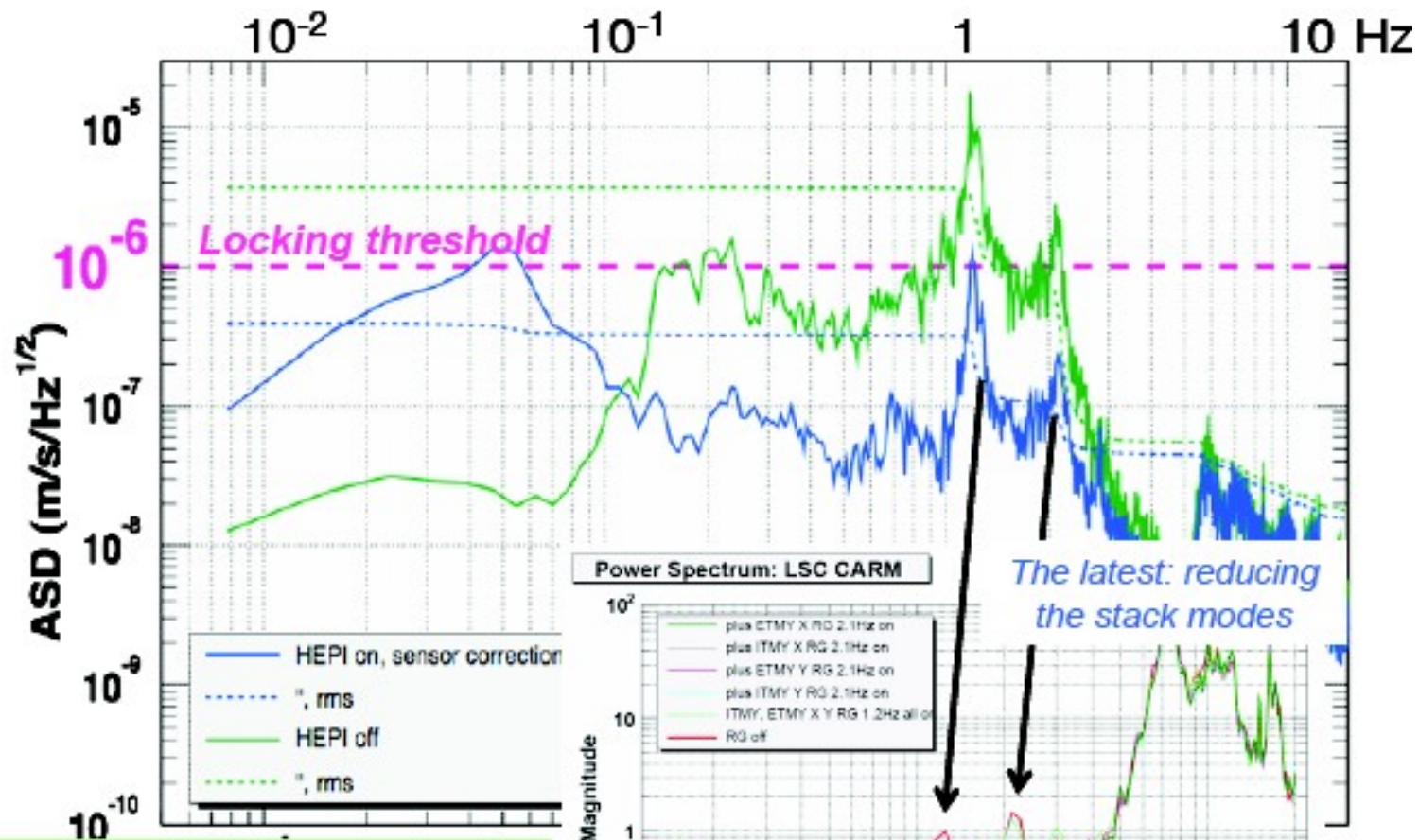

Allows L1 to lock during "typical" noisy days

- Heat optics using CO₂ laser
 - to counter the wave front distortion caused by the absorption of interferometer beam in the substrate

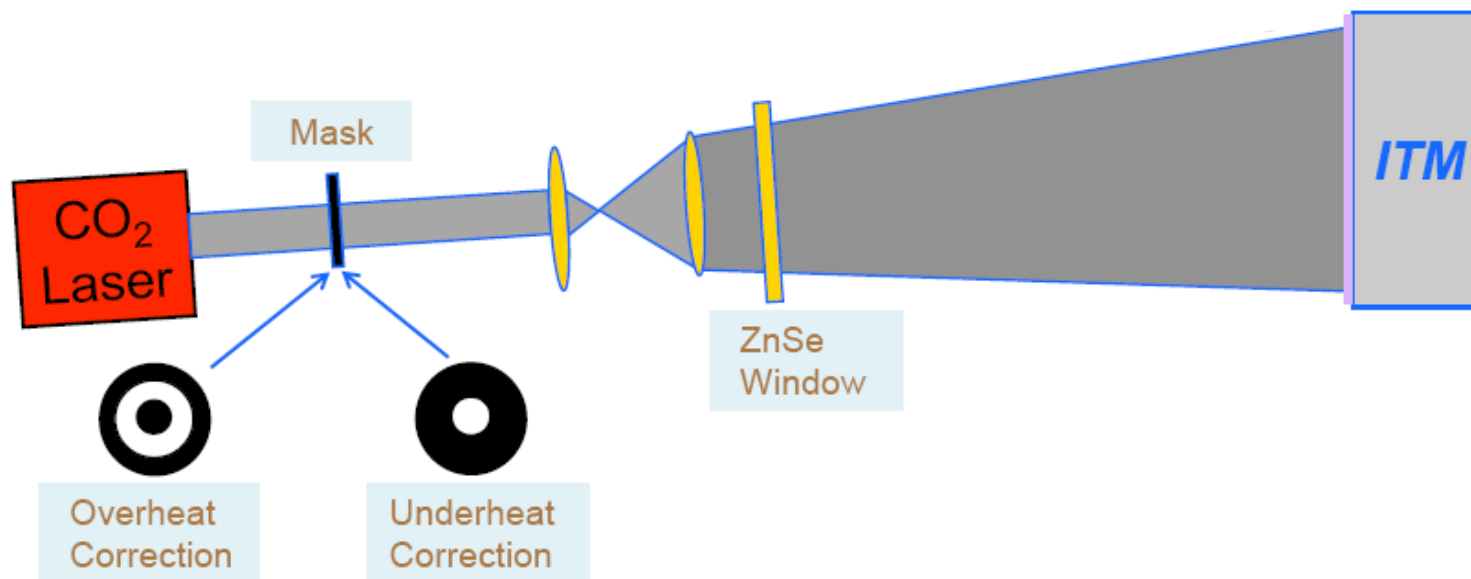

Early implementation of AdLIGO technique

