

# *Challenges in Cryogenic Interferometers*

*Roberto Passaquieti*

*University of Pisa*

*INFN Virgo Group of Pisa*

Australia-Italy Workshop on GW Detection

Gingin, 6<sup>th</sup> October 2005

**LIGO-G050529-00-Z**

# Summary

- **The EGO Cryogenic R&D Program**
  - The EGO cryogenic facility
  - Test payload (marionette+mirror) description
  - List of the main investigations
- **The Cryogenic Superattenuator Design Studies**

# **Part I**

## **The EGO Cryogenic R&D**

# *Guidelines of the cryogenic EGO R&D*

- **The program of this R&D consists of building a cryogenic test facility at the EGO site, to test mirrors and coatings, and to measure their Q down to 4K. The design and the realization of the test payload (TP) and its suspension system are also part of the program.**
- **To cope with the cryogenic environmental conditions it will be also necessary:**
  - to investigate the low temperature material properties (thermal conductivity, thermal expansion, mechanical losses, fragility, etc.)
  - to investigate new cryogenic anti-seismic suspension systems .

# *Subscribers and Participants*

- **This R&D project has been presented the 20th October 2002 with a LoI signed by the following groups:**
  - ESPCI, CNRS, Paris (F)
  - ILGA, OCA and CNRS, Nice (F)
  - INFN & University, Firenze-Urbino (I)
  - INFN and University, Perugia (I)
  - INFN and University, Pisa (I)
  - Laboratoire Kastler-Brossel, CNRS, Paris (F)
  - LAPP, IN2P3-CNRS , Annecy (F)
  - Leiden Institute of Physics (NL)
  - SMA, IN2P3-CNRS, Lyon (F)
    - Declared interest of participation from groups of GEO experiment (Glasgow, Hannover, Jena).
    - ACIGA-UWA contribution for the actuator and sensor system.

# *Actual Contributions from the Collaboration*

- **The activities up to now have requested the following contributions:**
  - **ACIGA group**: mechanical exciter and capacitive readout system.
  - **EGO**: facility infrastructures, vacuum, electronics, computing, TP FEA.
  - **INFN Perugia group**: TP design, silicate bonding.
  - **INFN Pisa group**: laboratory organization, TP design and simulation, TP assembly and transportation system design.
  - **Leiden group**: project of the cryostat.
  - **Pisa University group**: TP simulation.

# Thermal Noise (TN)

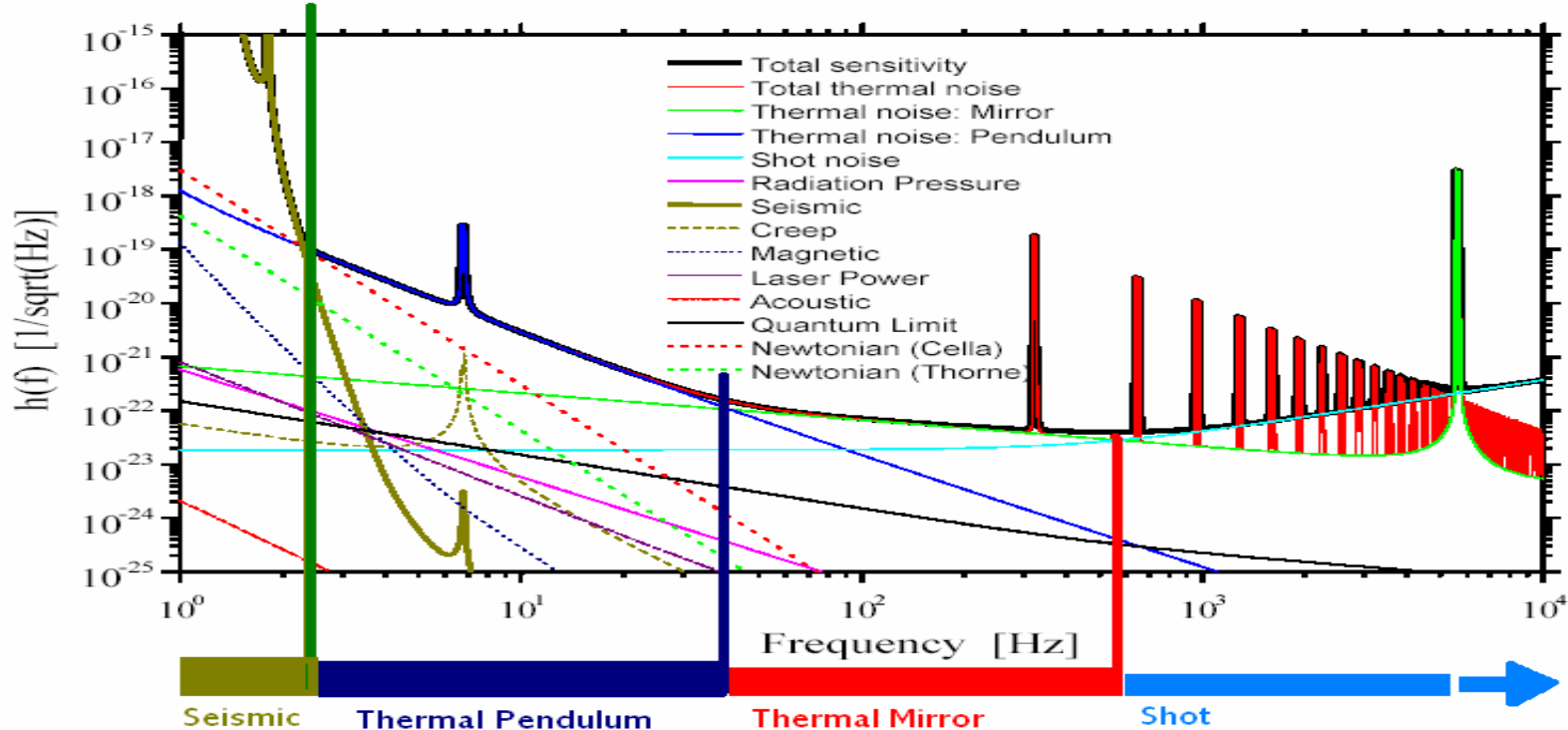

- **In Virgo, at room temperature, thermal noise has the following contributions:**
  - suspension pendulum thermal noise will dominate in the 3-50Hz frequency band.
  - mirror thermal noise will dominate in the 50-500Hz frequency band.

# Mirror Thermal Noise

- At room temperature substrate-coating friction losses strongly dominate the mirror TN.
- According to the Japanese experience the coating losses seem not to decrease with temperature.
- **Still the thermodynamic factor  $T^{1/2}$  should guarantee almost a factor 10 decrease of mirror displacement TN at 4K .**
- **Object of EGO R&D:**
  - To carry on 1:1 scale investigations on substrates and coatings losses at 4 K.

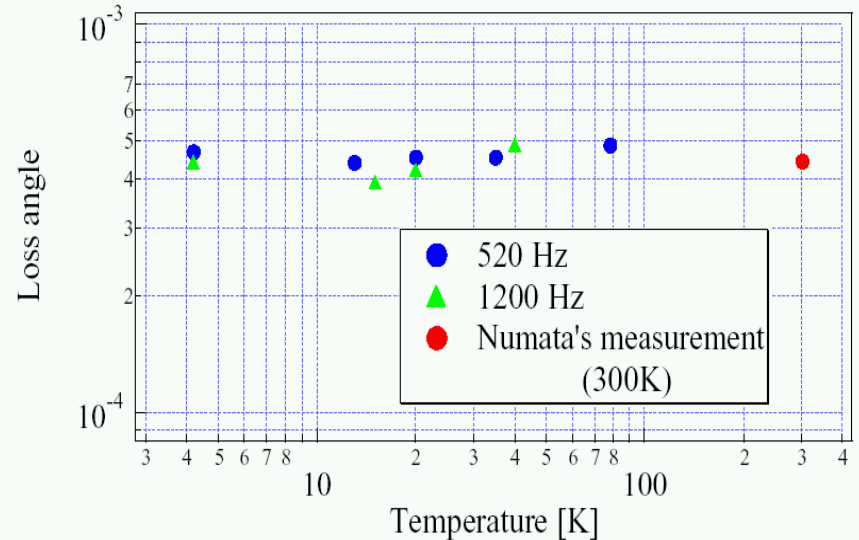

Ta<sub>2</sub>O<sub>5</sub> coatings, Yamamoto 2003



# *EGO Cryogenic Test Facility (EGO-CTF) Description*



- **The EGO-CTF consists essentially of a cryostat with an inner 4K chamber which is able to contain a TP with one anti-seismic filter stage.**
- **It was decided to make use of an area within a large building at the mid of the West arm of the Virgo interferometer, and to suspend the cryostat over a pit in the ground floor (length=13.8 m, width=5.45m, depth=1.95 m).**

# Project of the EGO-CTF Infrastructure

By P. Popolizio, L. Paoli, A. Paoli

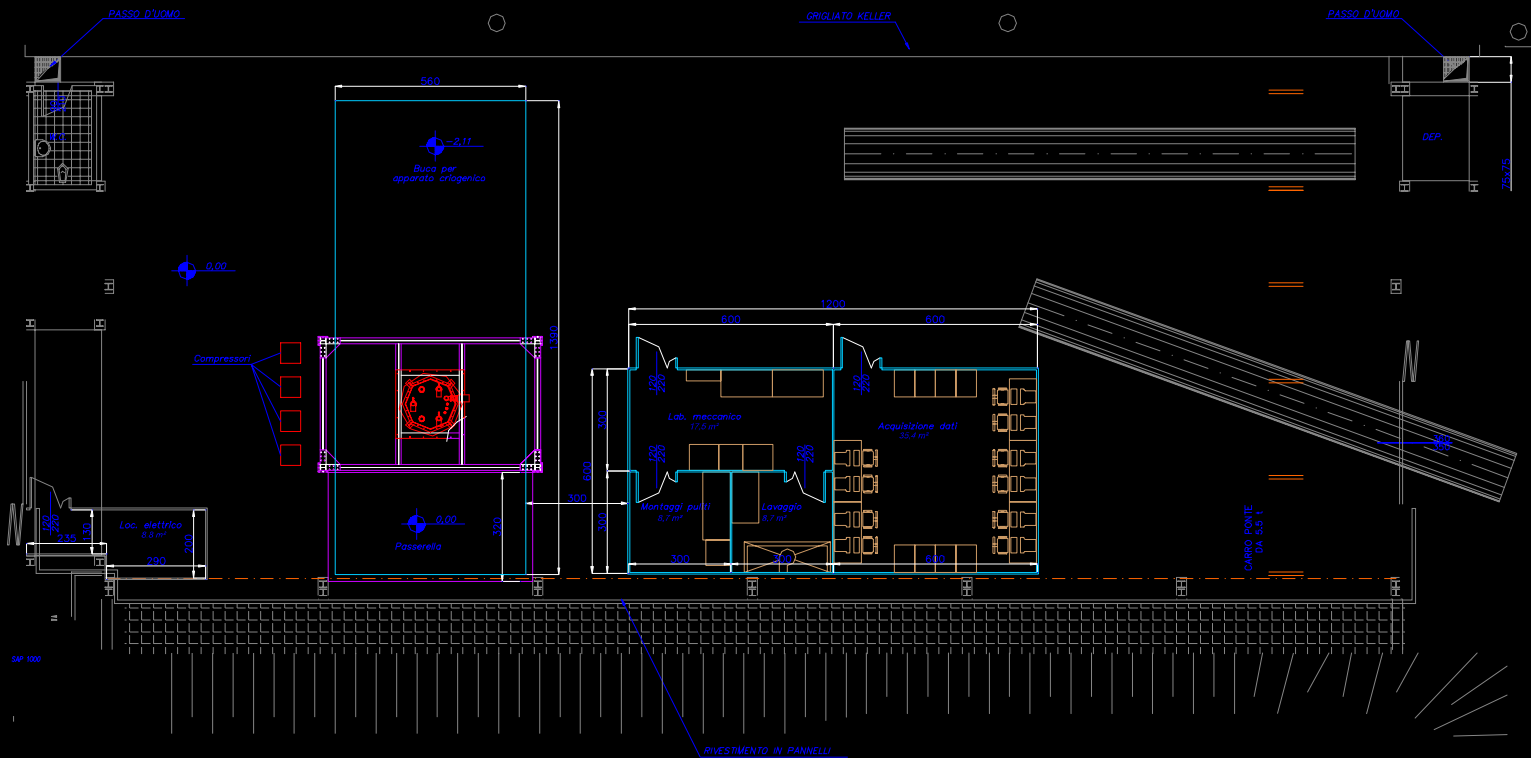

# *Status of Works at the EGO-CTF*

- **The EGO-CTF infrastructure works are quite advanced:**
  - the pit on the ground is completed;
  - the cryostat suspension structure is assembled;
  - the computer room and the laboratories are foreseen to be delivered by the end of October.



# *Cryostat Support and Service Structures*

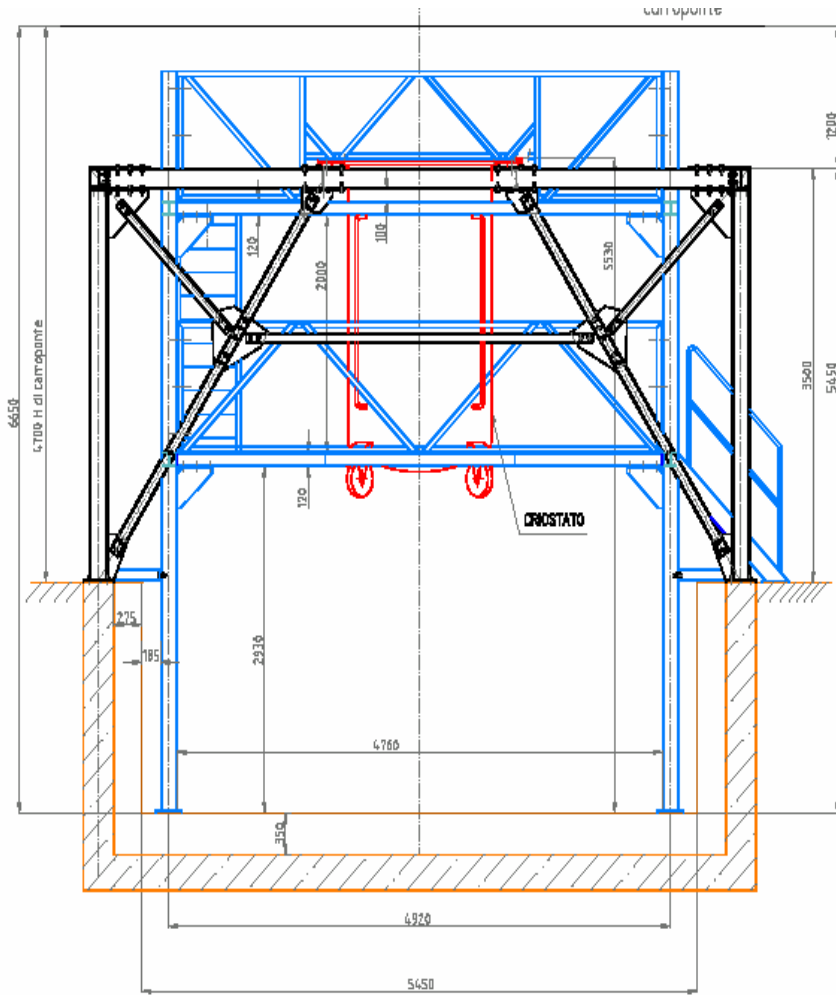



# The EGO-CTF Cryostat

- The designed cryostat consists of an external vacuum-proof steel cylindrical container (2.6m height, 1.4 m diameter).
- Inside the room temperature container there are two nested Al chambers which are foreseen to reach their thermal equilibrium respectively at about 80K and 4K.
- The 4K chamber will host the TP; it has an height of 2m and a diameter of 1.2m, and it will be also vacuum-proof to allow the introduction of exchange gas

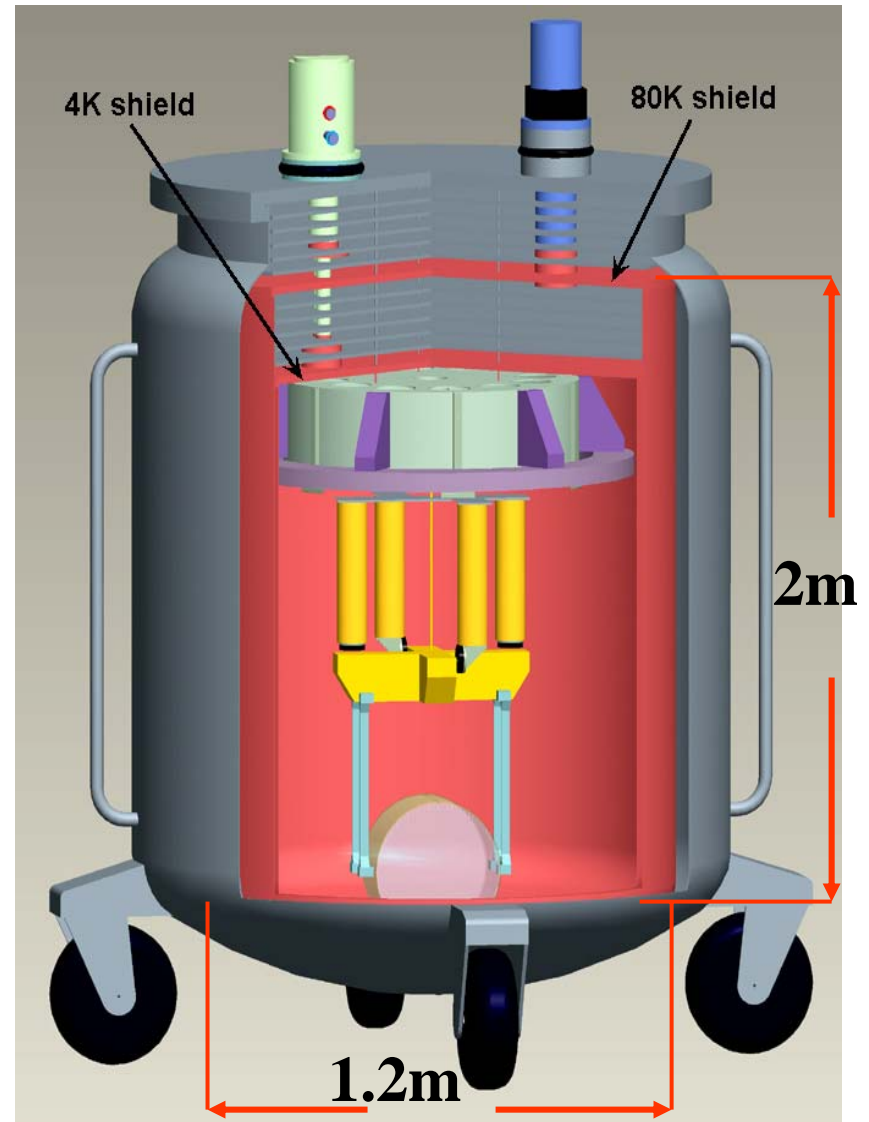

# Cryostat Design Upgrades

- The design of the cryostat has been changed to overcome initial underestimated technical problems.
  - The inner 4K chamber has been modified:
    - to allow for the introduction and the evacuation of exchange gas for a faster cooling of the payload.
    - to allow for the possible use of a laser beam and of a other monitoring devices.

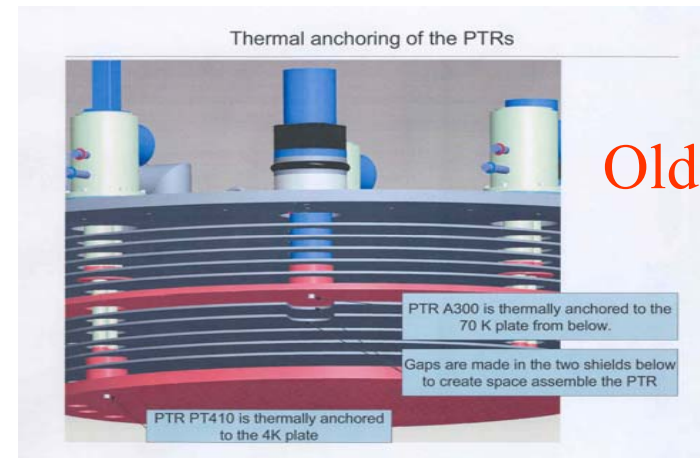
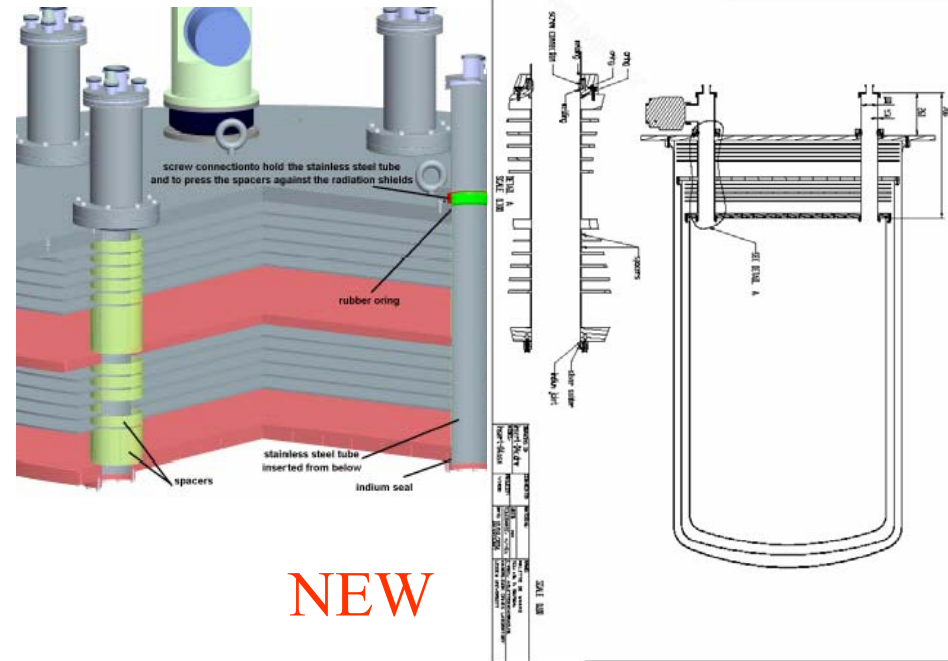

# The Pulse Tube (PT) Refrigerator

- The PT refrigerator essentially achieves cryogenic temperature by expanding high pressure He gas to low pressure. It is similar to a Stirling Refrigerator, with the displacement mechanism of the Expander replaced by the Orifice/Reservoir.
- A compressor supplies pressurized He gas ( ~15 bar) through flexible metal hoses. The rotary valve (a) directs He in and out the PT (~ 2Hz) generating an acoustic pulse.
- The regenerator (d) acts to pre-cool the incoming pulse before it reaches the cold heat exchanger.
- The reservoir (b) and the two orifices (c) work together to obtain the most efficient phase shift between the pulse and the He gas flow into the PT.

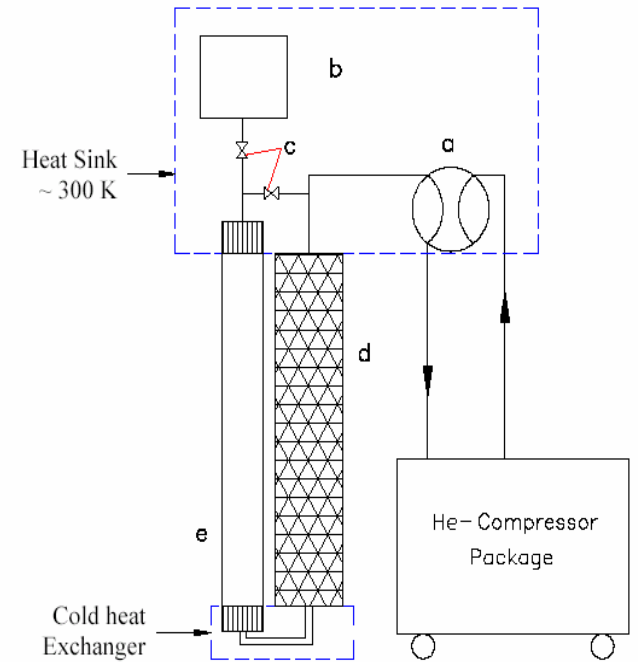

a: rotary valve; b: reservoir; c: orifices; d: regenerator; e: pulse tube;

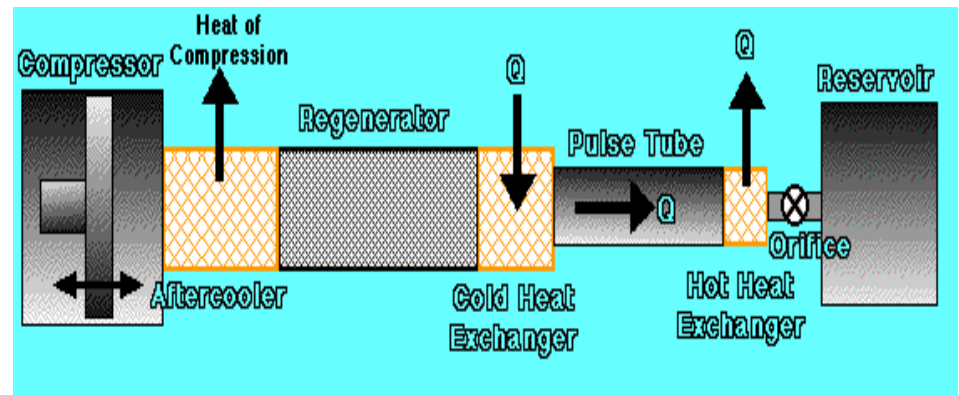

# The Cryomech PT Cryo-coolers

- The cryo-cooling system is initially based on two PT refrigerators (from Cryomech, USA), able to extract together ~100W at the 80K stage and ~1W at the 4K stage.
- This type of refrigerator guarantees:
  - simple installation,
  - easy maintenance,
  - good reliability,
  - low operation costs.
- Rotary valve mechanical vibrations and acoustic noise can be sources of problems.



**PT60W:**

**Power: 3kW @ 50Hz**

**Stage1: 60W @ 80K**

**Cool.Thr.: 0W @ 30K**

**Cooling: Liquid**

**Acoust.N.:70dB @1m**

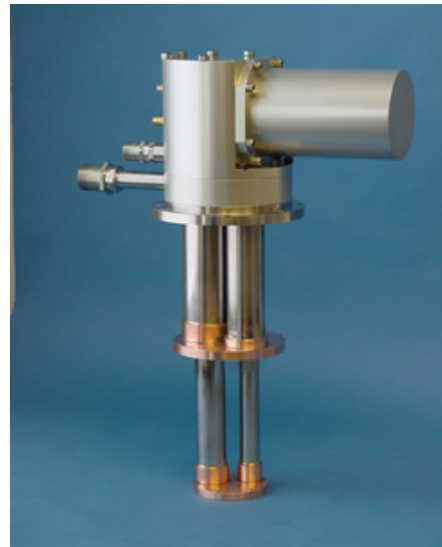

**PT410W:**

**Power: 7.2kW @ 50Hz**

**Stage1: 40W @ 25K**

**stage2: 1W @ 4.2K**

**Threshold:0W @ 2.8K**

**Cooling: Liquid**

**Acoust.N: 70dB @1m**



# *Pulse Tube Cold Head Anchoring*

- Care has to be taken to reduce vibrations.
- Anchoring of the PT cold head will be made with appropriate high compliance jellyfish

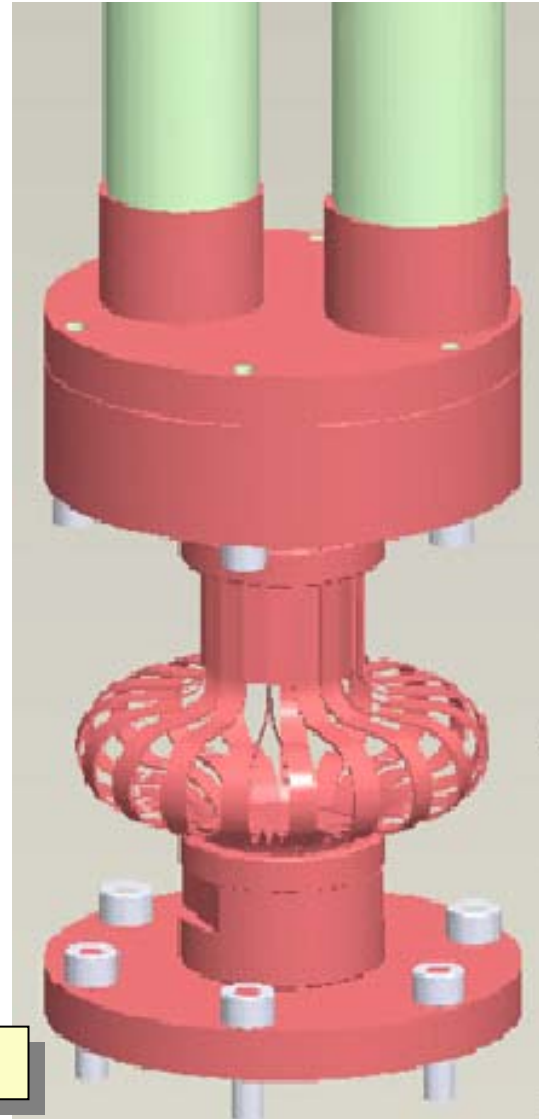
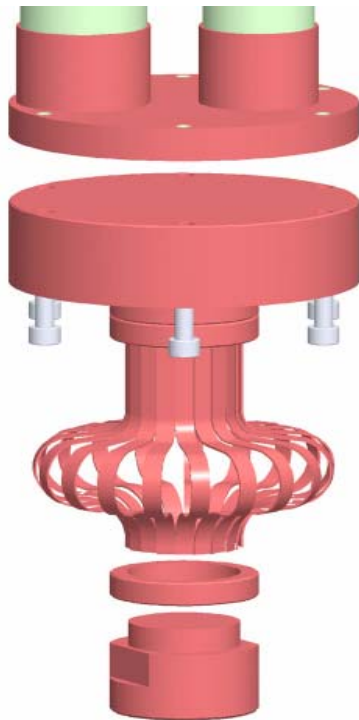

By A.deWard

# Pulse Tube Flexible Hoses Line

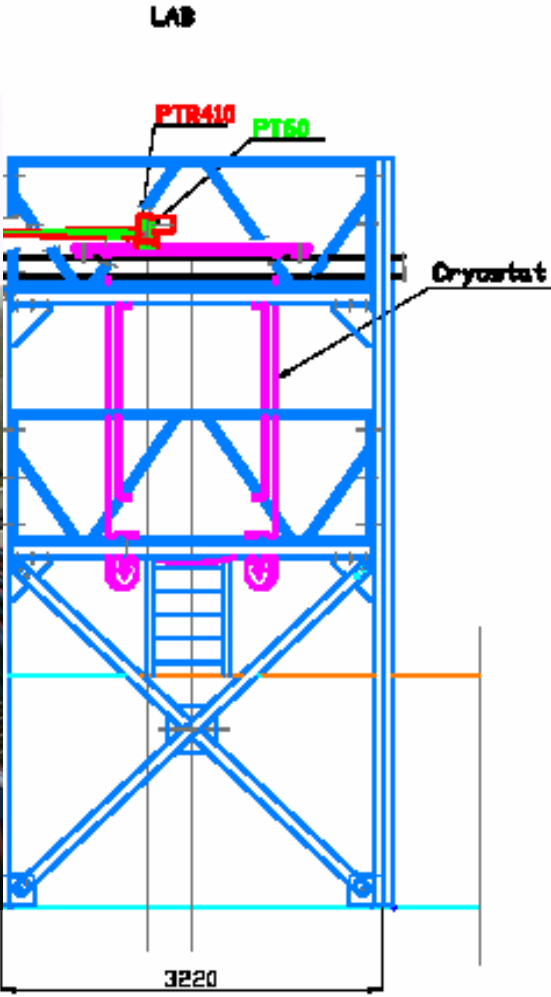

## **Status of the EGO-CTF Cryostat.**

- **Cryomech Pt and compressors, are already purchased.**
- **PT compressors and water cooling system building will be delivered by the end of October.**
- **The last version of the cryostat design was ready from March 2005, its production has been completed and vacuum leak tests will be performed in Germany at the workshop site (Cryoanlagenbau) during the period 17-21 October 2005. Its installation could begin in November.**

**Part II**  
**Cryogenic Test Payload (TP) Design**

# *TP Design Guidelines*

- **The design of a cryo-TP has been developed taking into account some fundamental guidelines:**
  - to be made of a single material to avoid problems in matching different thermal expansion coefficients when dealing with several thermal cycles of large amplitude;
  - to minimize losses using mono-crystal monolithic suspensions, avoiding contact frictions, with small contact surfaces;
  - to take into account the strength of joints and silicate bondings;
  - to allow the mirror cooling down to 4K.

# General Description

- The designed TP consists of a mono-crystalline silicon mirror (350mm diam., 100 mm thick, 22kg weight) suspended to a silicon marionette by two couples of low dissipative, monolithic silicon ribbons (30mm x 0.8 mm x 300 mm).
- This payload will be cooled down to about 4K to make measurements of the temperature dependence of the mirror Q, first without coating, and soon after with coating.

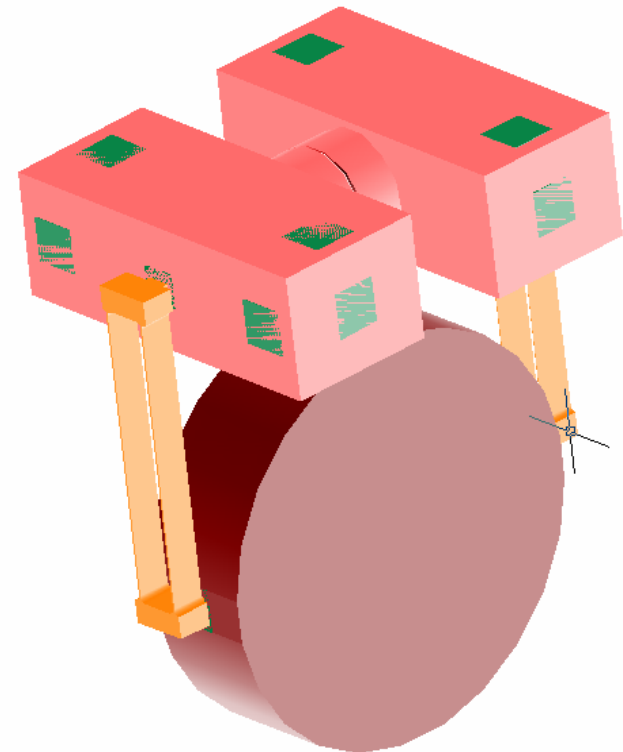
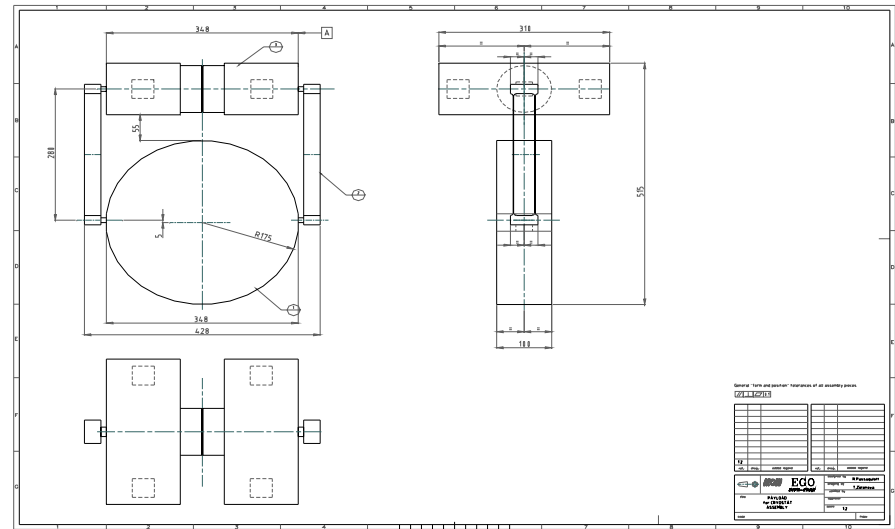

# Why Si for the Test Payload?

- **Si has been chosen for many good reasons:**
  - Available in large pieces to form high quality polished and coated mirrors.
  - Hydroxy catalysis ('silicate') bonding can be applied
  - High tensile strength ( $T_b \approx 1\text{GPa}$ ) and fatigue resistance.
  - Its intrinsic loss angle is expected to be very low:

Si bar 4.9 kg, longitudinal mode:

$$\Phi(300\text{K}) = 2.8 \times 10^{-8}, \Phi(77\text{K}) = 5 \times 10^{-9}, \Phi(4.2\text{K}) = 6 \times 10^{-10}$$

Measured by McGuigan et al (1978), rep. by J. Ferreira in The Detection of Gravitational Waves ed. D.Blair

- Its thermal conductivity increases at low temperature pushing up the frequency of the residual thermo-elastic peak at values where the thermal noise contribution is not dominant.

$$\phi_{ThSusp}(\omega, T) = \frac{E\alpha^2 T}{c_v} \cdot \frac{\omega\tau}{1+(\omega\tau)^2} ; \quad \tau \approx \text{const} \left( \frac{c_v}{\kappa} \right)$$

**K = thermal conductivity**  
 **$\alpha$  = thermal expansion coeff.**

# Material Properties of Silicon

- **At low temperatures Silicon shows really unique properties:**
  - its thermal expansion coefficient  $\alpha$  shows two zero crossings at  **$\sim 123\text{K}$  and  $\sim 17\text{K}$** .
- **Noise processes acting via thermal expansion coefficient, like**
  - thermodynamic noise:  $\sim (\alpha)$
  - photo-thermal noise:  $\sim (\alpha/k)$**tend to be negligible as Si approaches these low temperatures.**
- **Its relatively high thermal conductivity has also the positive effect of reducing mirror thermal lensing**

$$\delta d = \alpha d_0 \delta T \approx (\alpha/k) d_0 W_{abs.}$$

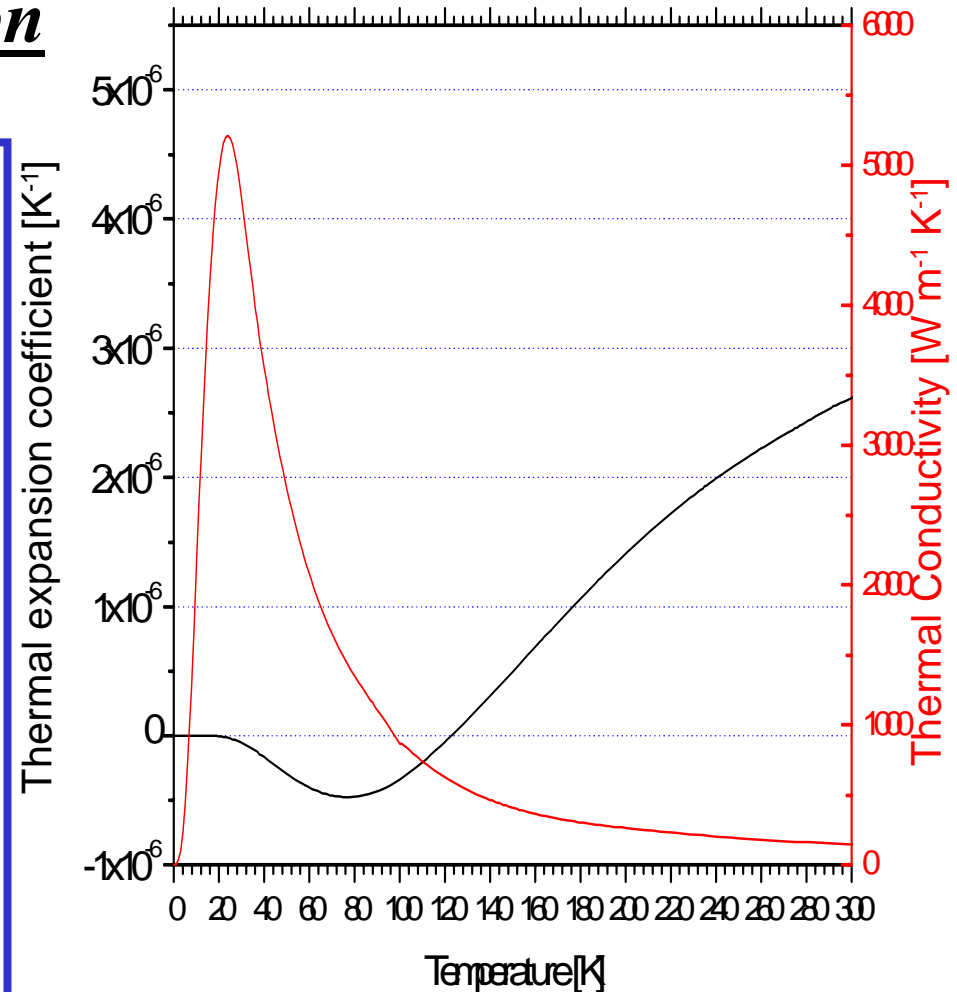

P Amico *et al* Class. Quantum Grav. 21 (2004) S1009–S1013



# *Silicon Optical Transmittance*

Si transmittance is very poor at the 1.064 $\mu\text{m}$  Nd:YAG wavelength of currently used lasers.

It increases a lot going to about 1.5 $\mu\text{m}$ .

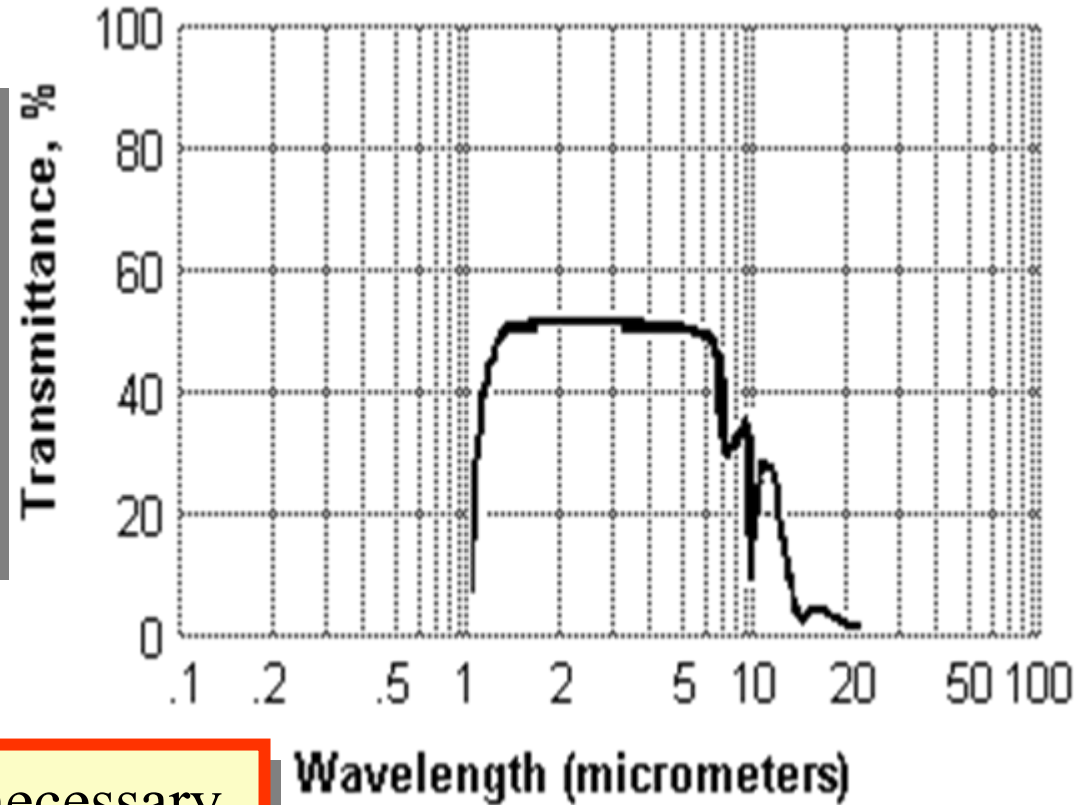

In order to use Si mirrors, it is necessary to change the laser wavelength.

New promising Er-YAG lasers with  $\lambda \sim 1.6\mu\text{m}$  (St. Gobain Crystals claims for  $\lambda \sim 2.9\mu\text{m}$ )

# Silicate Bonding-Strength

- Hydroxy catalysis (or 'silicate') bonding on fused silica much tested at room temperature (typical catalyzers KOH, NaOH,...).

- great strength dependence on:

- bonding solution dilution
- surface polishing (Best values for  $\lambda/10$  @633nm)
- edge micro-cracks
- water aging



Great attention in dimensioning the contact surfaces that will be silicate bonded

safe shear stress ~ 1MPa

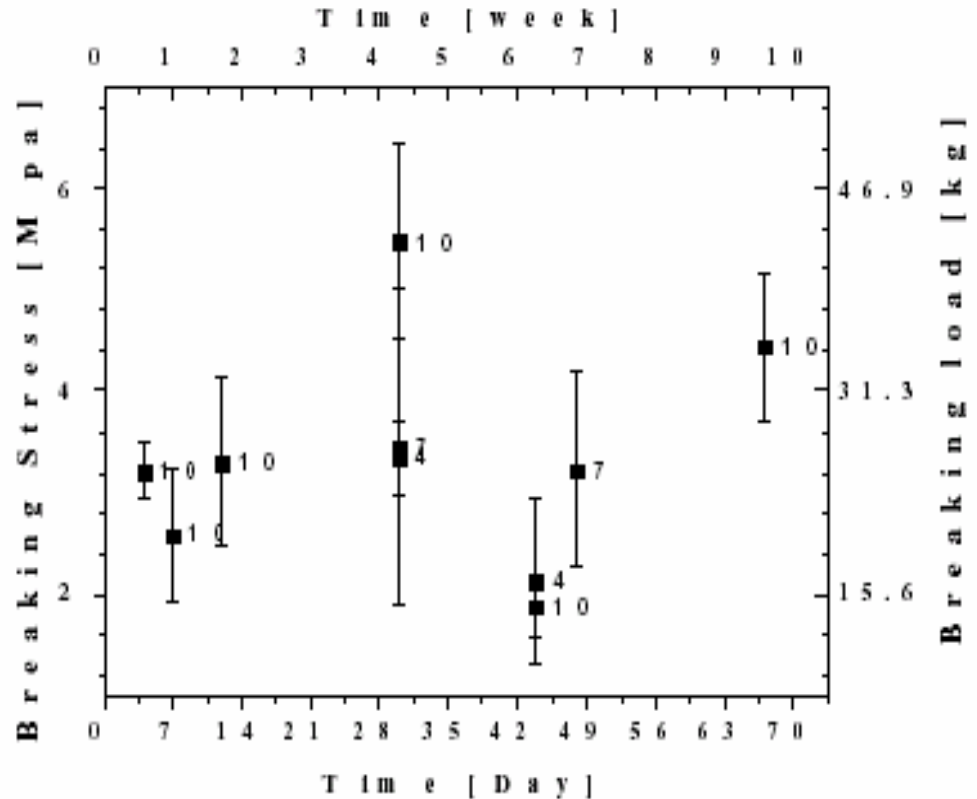

Rev. Sci. Instr. 73 (9) Sept. 2002: 3318-3323

# FEA of the Ribbons Deformation

- FEA of test payload ribbons (30mmx1mmx300mm) has been performed

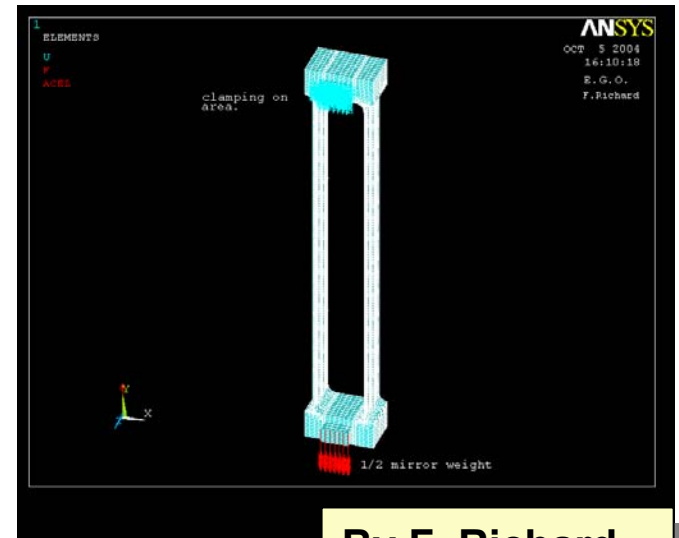

By F. Richard

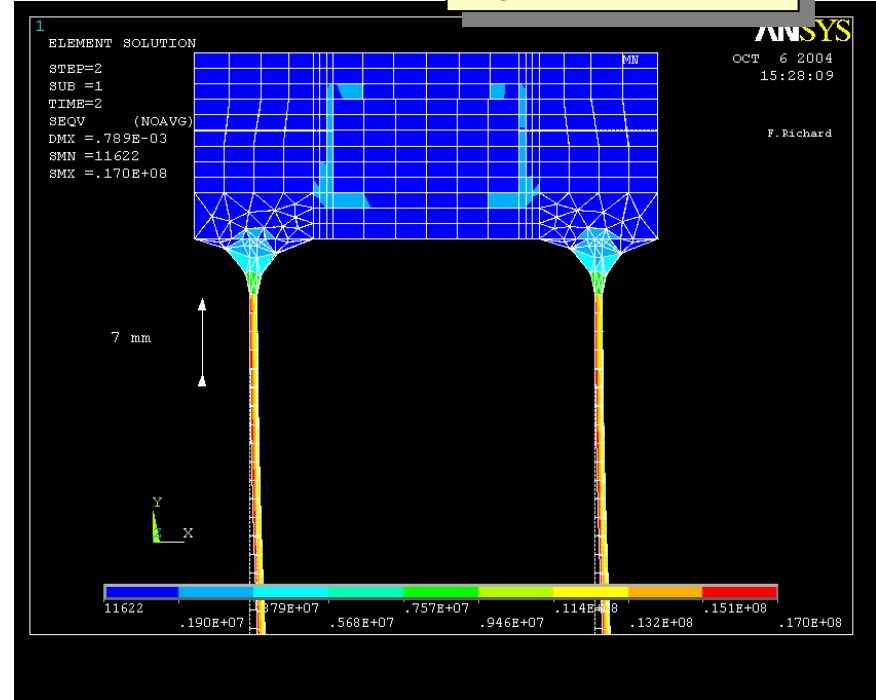
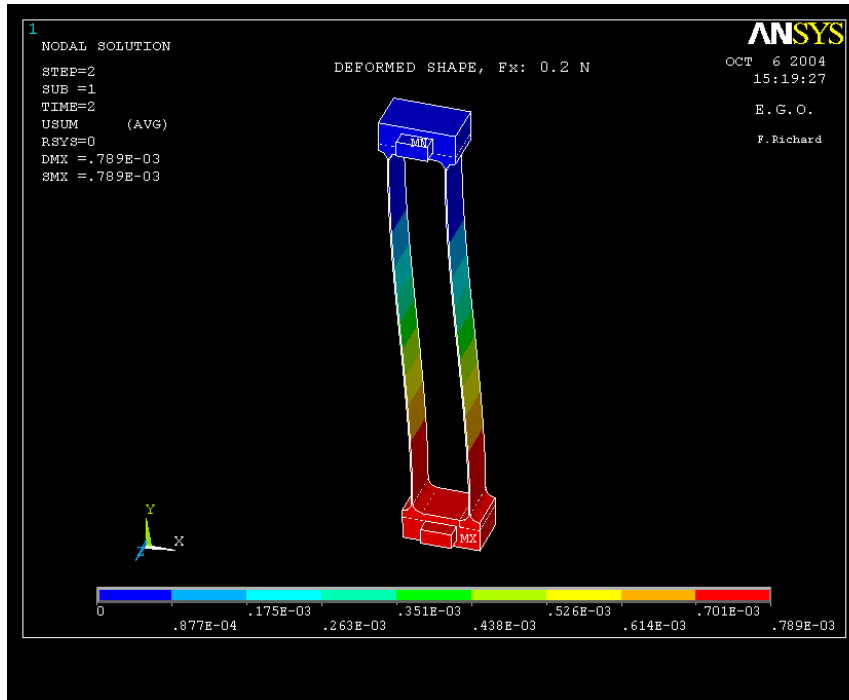

# FEA of the Ribbons Shear Stress

- Shear stress on the silicate bonded surface for different longitudinal mirror displacements has been investigated

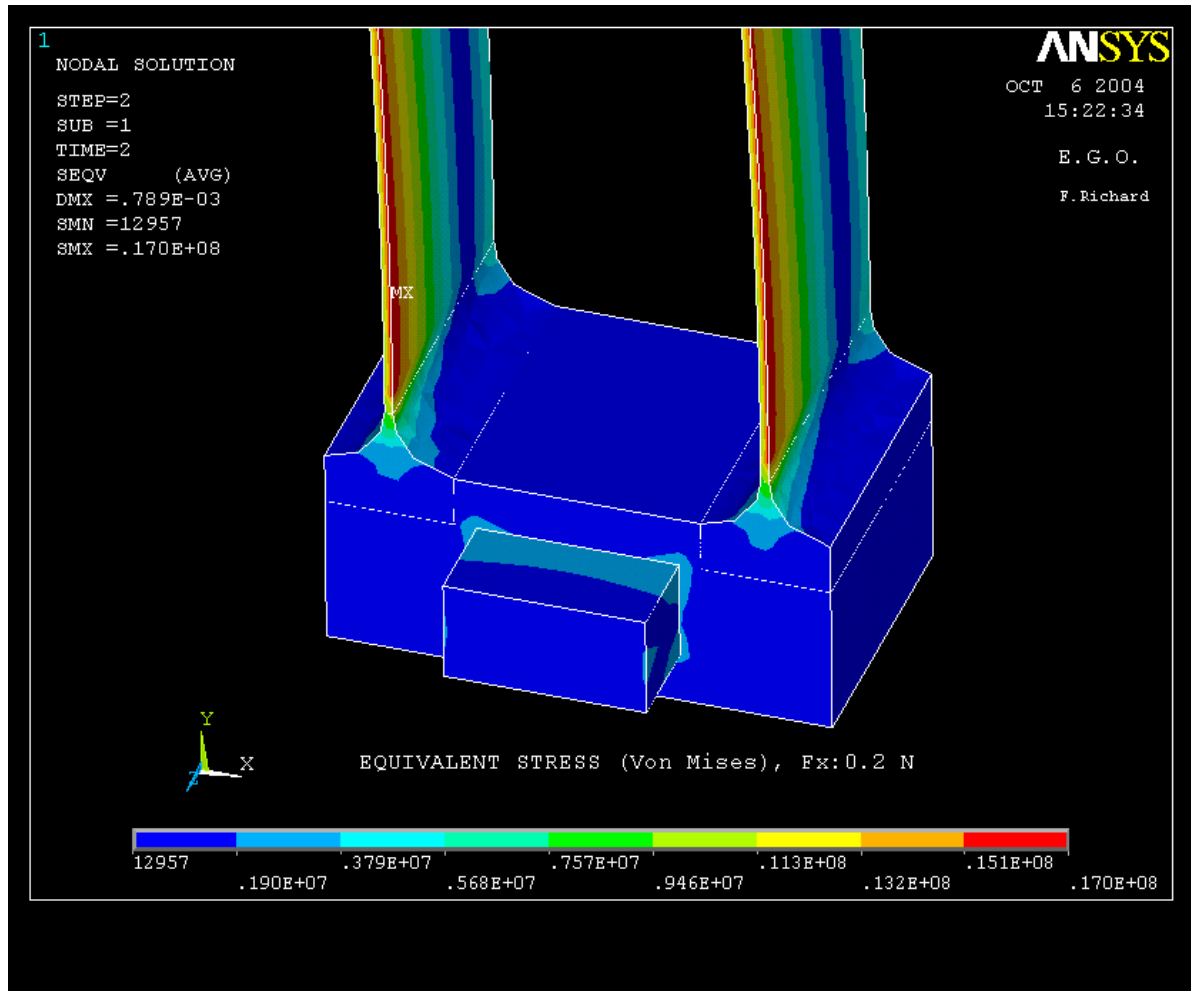

# Silicon Ribbons Mode Shaping

- Also FEA harmonic analysis to extract mode frequencies has been carried out.

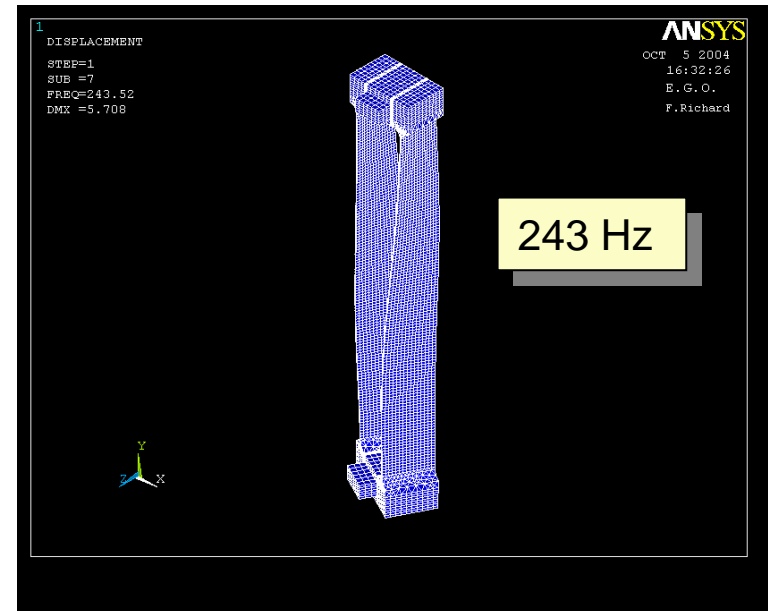
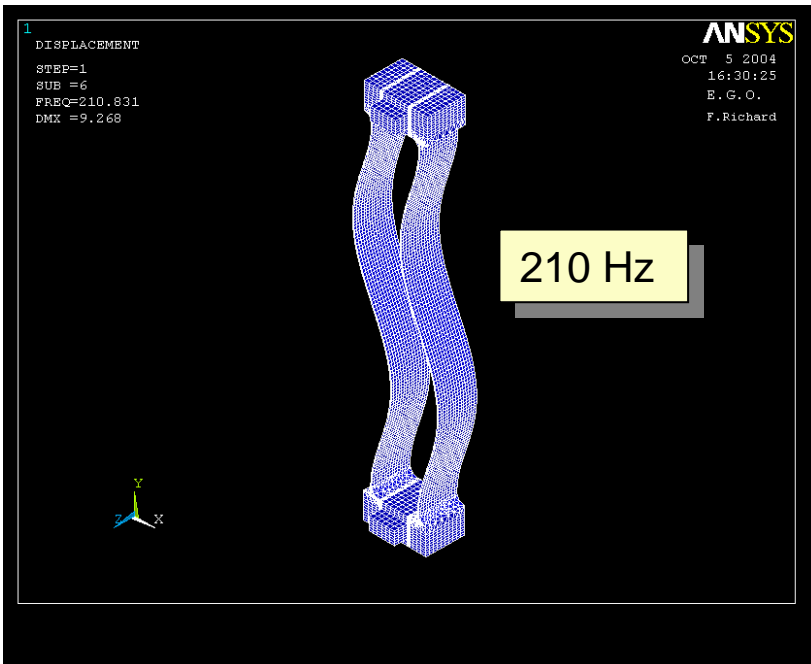
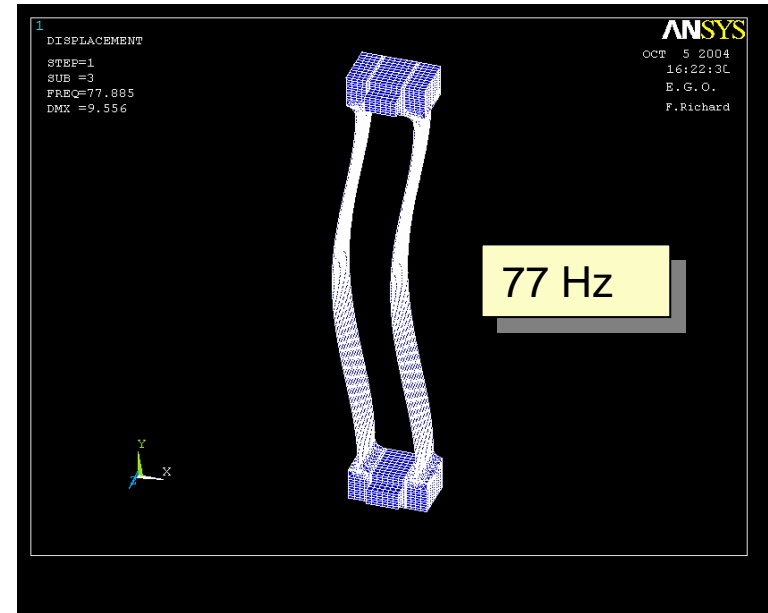

 --> Mirror\_Z , Red --> Mirror\_ThX , Pink --> Marion\_Z Green --> Marion\_ThX

**Payload TFs\_FORCE@Mario\_CM**

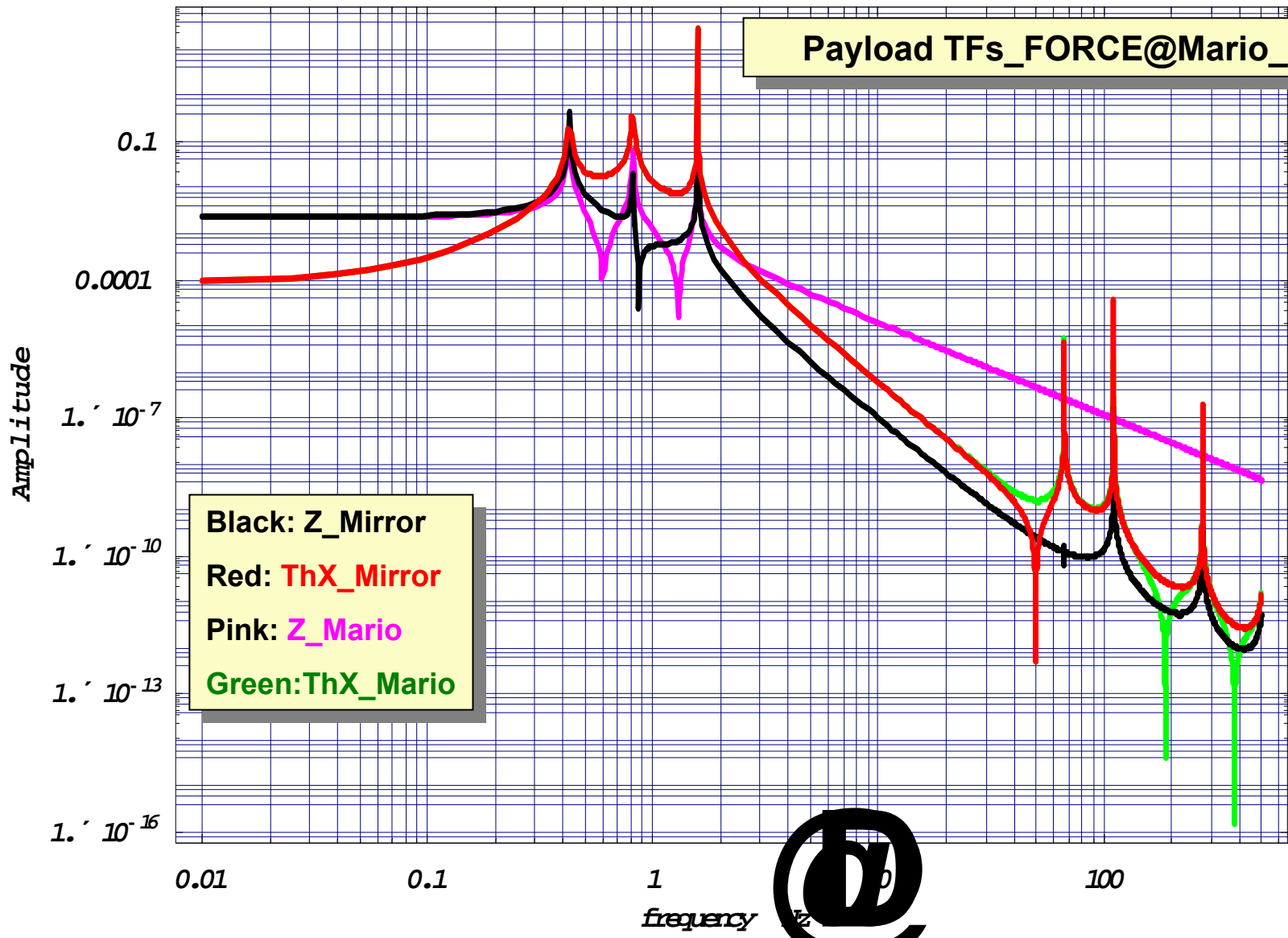

# Payload Thermal FEA

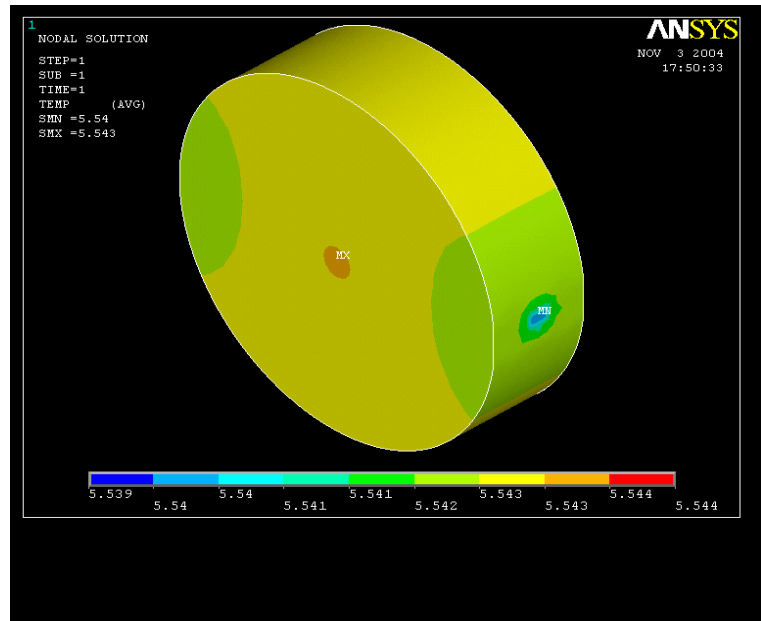
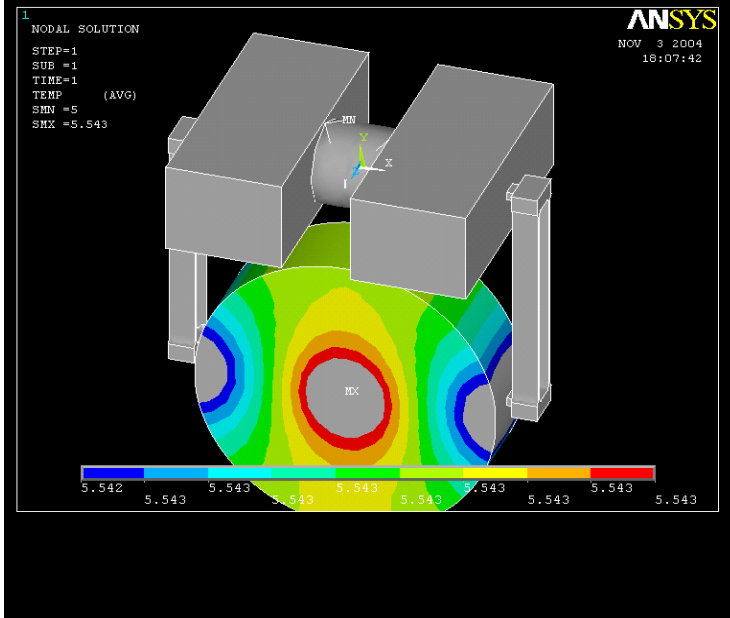
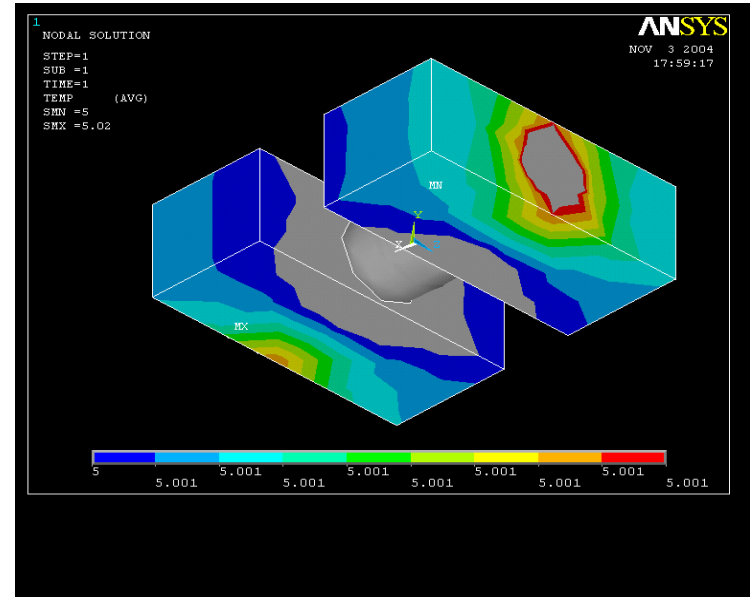
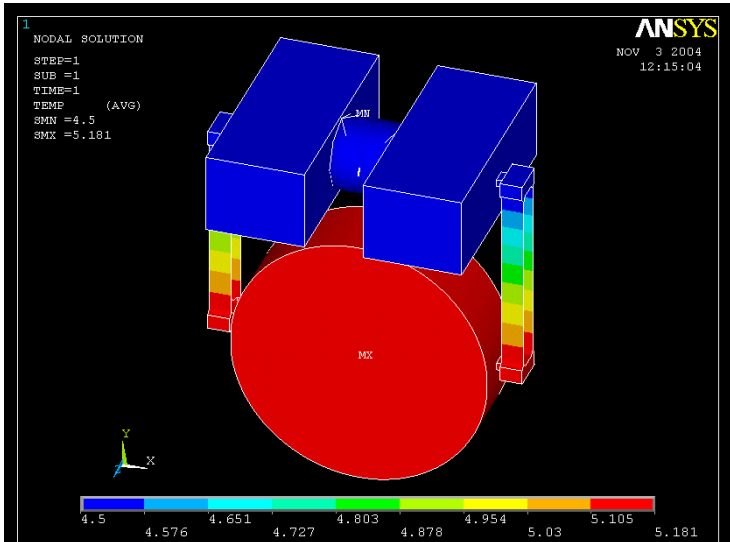

# *The Heat Transfer Problem*

- **The metal-Si thermal link should not introduce significant extra stiffness while allowing about 1W heat flow @ 4K .**
- **A possible scheme foresees the use of 2 copper rings tighten elastically to the silicon marionette near the suspending wire, and connected in a soft manner to the 4K roof of the cryostat chamber.**

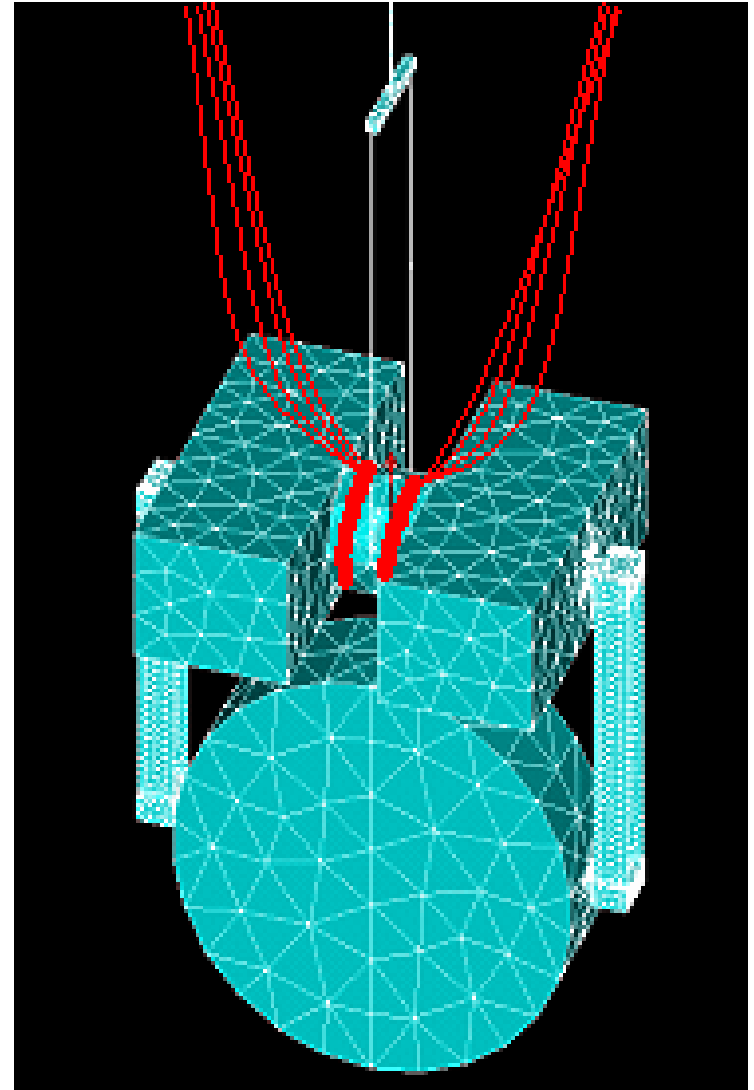



# *Excitation and Read Out System*

- **Two methods of excitation:**
  - mechanical excitation to identify most normal modes
  - electrostatic excitation to excite individual modes.
- **The mechanical excitation uses a small relay to apply an impulse excitation.**
- **The electrostatic excitation and readout will use capacitive readout--bifilar coils .**
- **AIGO group is in charge for the design of this system.**

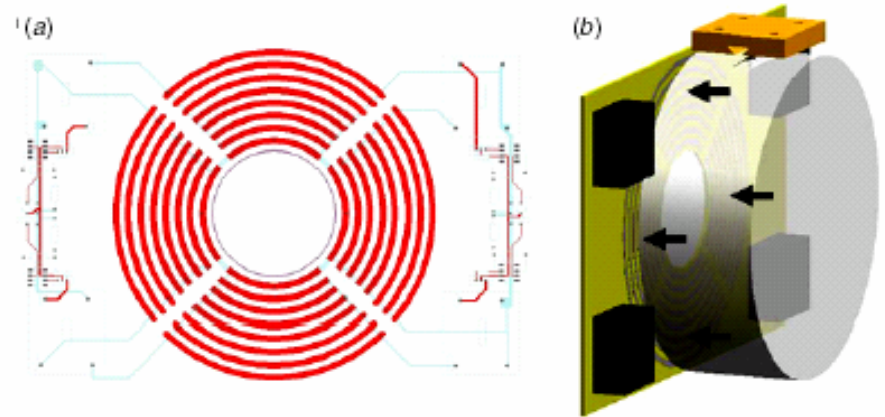

B H Lee<sup>1</sup>, L Ju<sup>1</sup>, C Zhao<sup>1,2</sup> and D G Blair<sup>1</sup>

Class. Quantum Grav. 21 (2004) S977–S983

# *Payload Delivery*

- **Since now quotations received for the realization of the designed TP payload are much higher than expected (about 150 k€).**
- **In order to reduce the costs we tried to simplify the design and also to contact other factories having the necessary capability.**
  - The main problems come with the monolithic Si ribbons production. Alternatives could be:
    - Silicate bonded prototype of separate Si parts
    - Ultra-sonic milling

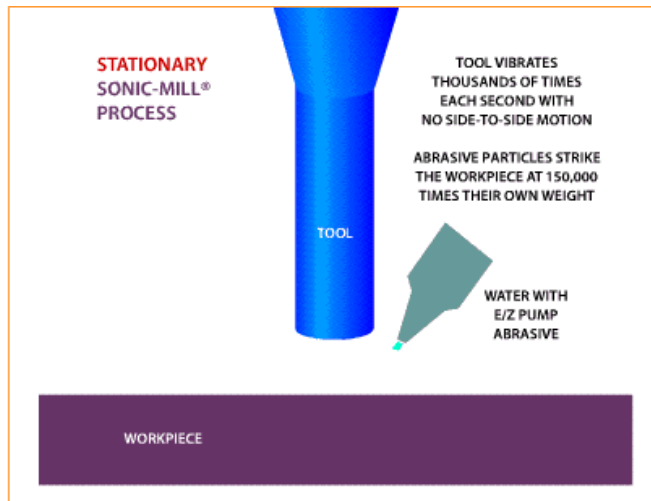

# **Part III**

## **Investigations at EGO-CTF**

# *Foreseen Investigations at EGO-CTF*

**While waiting for the silicon TP a dummy Al TP has been made.  
As soon as possible a series of investigations will start.**

- **Investigations with the dummy TP:**
  - precision assembly structure design;
  - handling and transportation system;
  - installation procedures;
  - low frequency modes cross-talk;
  - dummy Si ribbons high frequency modes;
  - capacitive actuators and sensors;
- **Investigations with the cryostat and the dummy TP:**
  - cryostat cooling efficiency
  - heat links efficiency (partially)
  - actuators and sensors down to 4K

# *Foreseen Investigations at EGO-CTF*

- **Investigation on silicon samples:**
  - silicate bonding strength down to 4K;
  - silicate bonding losses down to 4K;
  - silicate bonding thermal resistance down to 4K;
  - coating behaviour at 4K and after cooling cycles;
- **Investigation on cryostat and scale 1:1 silicon TP**
  - Test and validation of the heat extraction system
  - Investigation on TP mirror substrate losses down to 4K
  - Investigation on TP mirror coated losses down to 4K
  - Investigations on effects of heat release on mirror at 4K (thermal lensing and its compensation)

# *Foreseen Investigations at EGO-CTF*

- **FEA and any other kind of simulation should go on looking for possible alternatives on any specific item concerning the test payload**
  - mode decoupling
  - heat transfer
  - control
- **Looking for possible long term measurements**
  - Investigation on refrigerator noise attenuation
    - passive
    - active

# *Induced Research and Synergies*

- **The activity on this R&D has induced a further research line (INFN Pisa-EGO) devoted to the study of low temperature material properties.**
  - A small cryostat is going to be placed in the laboratory of the EGO Cryogenic Facility.
  - Pisa group has purchased a 2 stage Sumitomo pulse tube (cooling power 0.5 W @4K).
  - The small cryostat could be available before the end of this year (EGO)
- **The EGO-CTF has also been presented to all members of the VESF and to the European ILIAS community.**

# **Part IV**

## **Challenges in Cryo-Superattenuator Design**



# Two alternative solutions to mirror heat extraction problem (A.Giazotto)

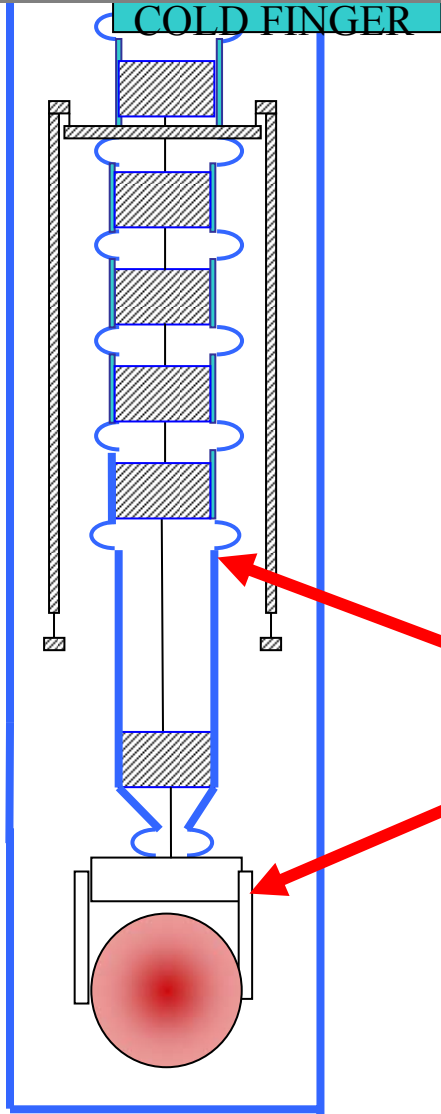

Very  
Soft  
Joints

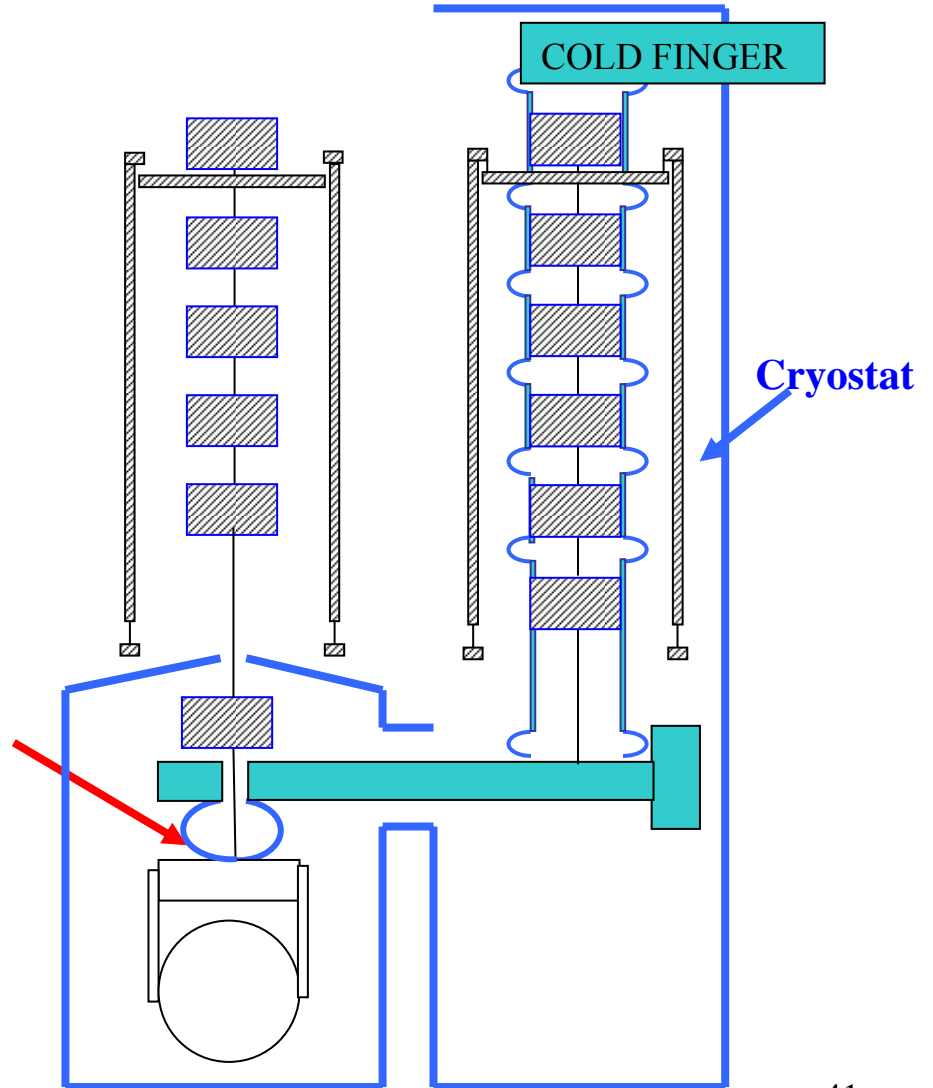

# Superattenuator Components

- **Superattenuator functional blocks:**
  - Filters
  - Blades
  - Magnets for anti-springs
  - Dampers
  - Sensors: LVDT
  - Actuators: coils+magnets
  - Cabling
  - Motors
  - Adhesives
- **Start of investigation on material cryo compatibility**

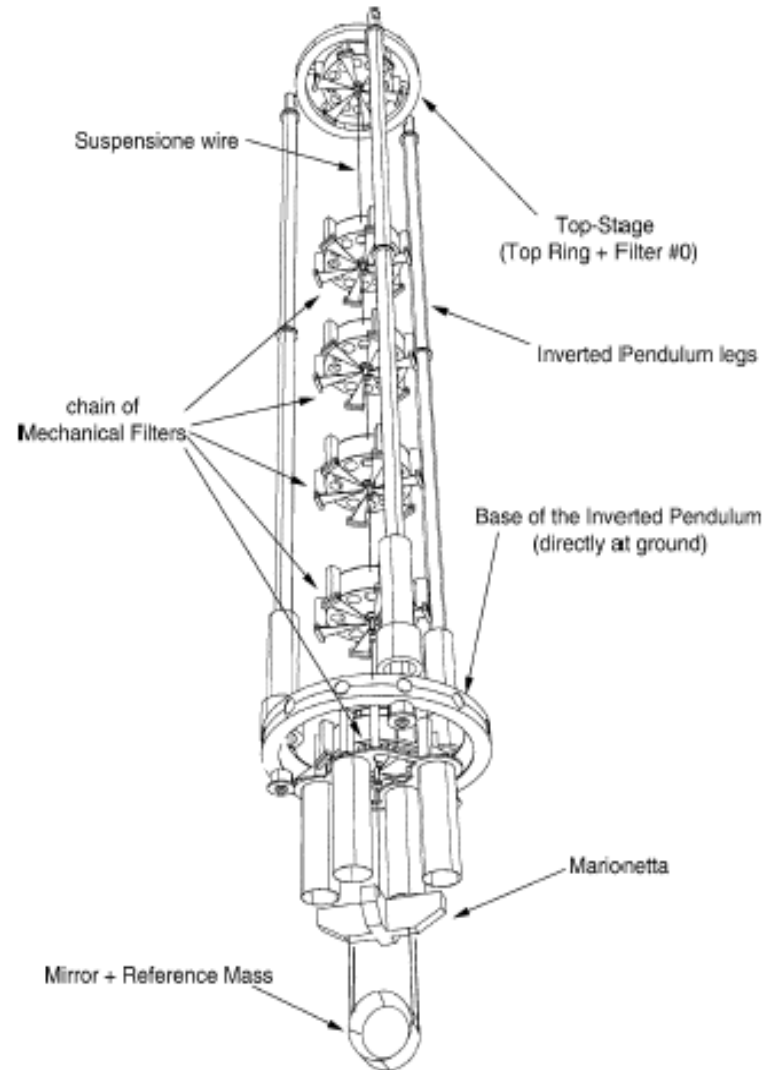

# *Cryogenic Properties of SA Materials*

- **Suitable materials:**
  - ferritic steels with 5-9 Ni
  - 300-series austenitic steels: 304, 304L, 316, 321, 304LN, 316LN
  - stable austenitic alloys: Fe-Ni-Cr-N alloys, Fe-Mn-Cr-N alloys and Inconel 908
  - OFHC copper and deoxidized copper
  - Al alloys: 6061, 6063, 1100
  - titanium, niobium
  - Invar
  - Kapton, mylar
  - quartz
- **Not recommended:**
  - martensitic steels (undergo ductile to brittle transition)
  - carbon steels
  - rubbers, plastics, Teflon
  - **Maraging:** 18Ni (200) series tested from room temperature down to 100K exhibits ductile fracture

## Test of Assembled Filter at 77 K and 4.2 K

- **Thermal contraction:**
  - Thumb rule: some mm/m contraction for metal rods between 300K and 4 K.
  - Problems: gaps/overlaps between different materials, misalignments, increased strains.
  - Most contraction occurs between 300K and 77 K: **significant test of assembled filter can be performed at liquid nitrogen temperature.**

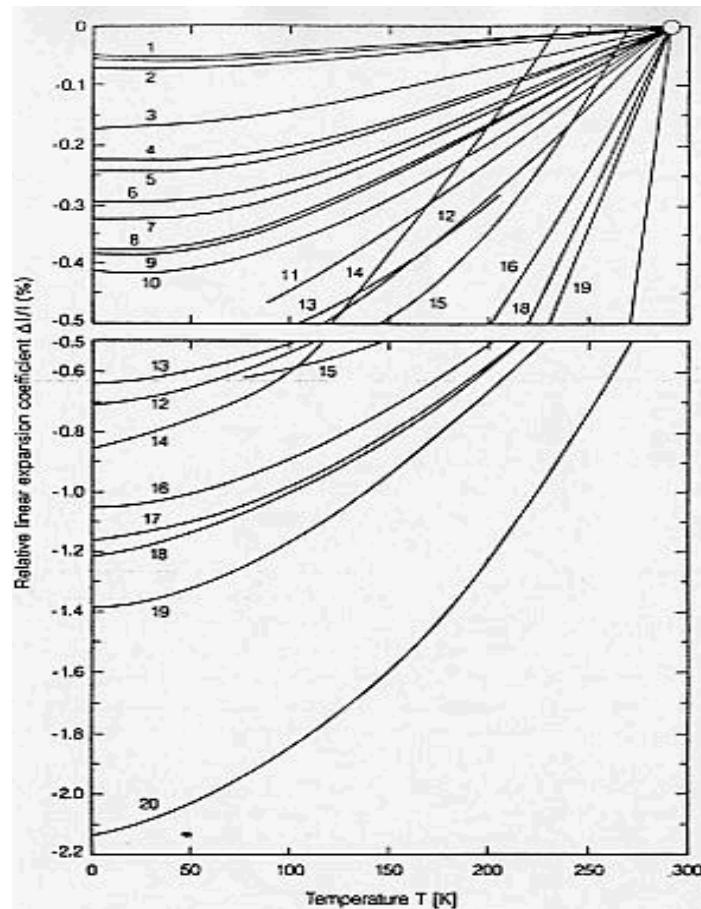

Fig.3.14. Relative linear thermal expansion coefficient of (1) Invar (upper), Pyrex (lower), (2) W, (3) non-alloyed steel, (4) Ni, (5)  $\text{Cu}_{0.7}\text{Ni}_{0.3}$ , (6) stainless steel, (7) Cu, (8) German silver, (9) brass, (10) Al, (11) soft solder, (12) In, (13) Vespel SP22, (14) Hg, (15) ice, (16) Araldite, (17) Stycast 1266, (18) PMMA, (19) Nylon, (20) Teflon [3.44]. Some further data are: Pt similar to (3); Ag between (9) and (10); Stycast 2850 GT slightly larger than (10). The relative change of length between 300 and 4 K is  $10^3 \Delta l/l = 11.5, 4.2, 6.3$  and  $5.7$  for Stycast 1266, Stycast 2850 GT, Vespel SP-22 and solders, respectively [3.43-45]

## *Cryogenics for VIRGO: suggested investigations*

- List of Investigations:
  - **Selection of material for heat link and measurement of thermal conductivity**
  - **Definition of mechanical and thermal behavior of materials for filter components; test of an assembled filter at 77 K and at 4.2 K**
  - **Test of mirror actuation at cryogenic temperatures**
  - **Quality factor of damping material at low temperatures, in case dampers will be used**
  - **Dimensioning of power and signal cabling keeping into account the heat transported by conduction and the heat produced by Joule dissipation**
  - **Test of LVDTs and accelerometers at cryogenic temperatures**
  - **Qualification of cryogenic motors in the working conditions of VIRGO**
  - **Test of adhesive strength and effect on quality factor of mirrors at low temperatures**
  - **Qualification of the pulse tubes from the point of view of vibrations**
  - **Design of a vibration free cryostat**

# *Suspension Prototype Assembly*

- **A small scale suspension prototype (LIGO-SAS) is going to be assembled at the Pisa INFN laboratories.**
- **This system is valid for both strategies: single/ancillary cryo-Superattenuator.**
- **It exhibits less cryogenic incompatible items (no magnets, no glue, no viton,.....) and could be used at 4 K with minor modifications**
- **Short term activity:**
  - room temperature tests on
    - blades
    - sensors
    - actuators
    - measurement of full chain TF.
- **Long term activity:**
  - replica of the tests at the EGO cryogenic test facility.



# Jellyfish Prototype

- **Working Principle:**
  - Superattenuator filters coupled with high compliance and thermal conductivity metal strips not degrading the isolation performance in all d.o.f.

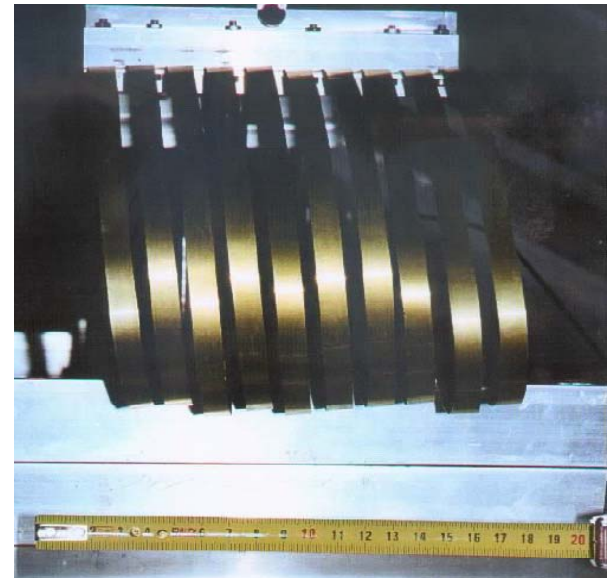
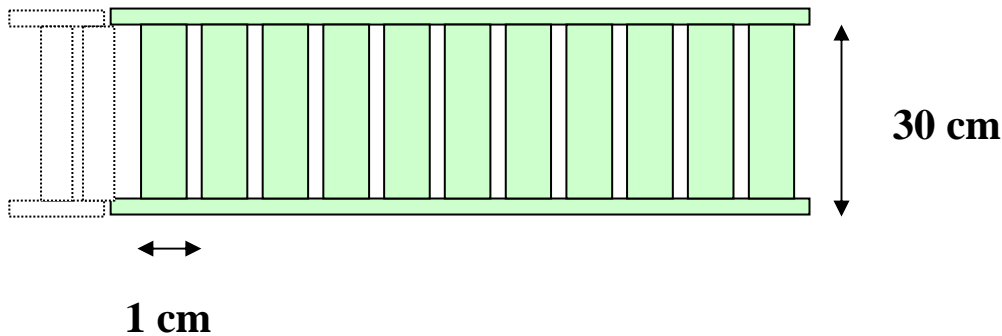
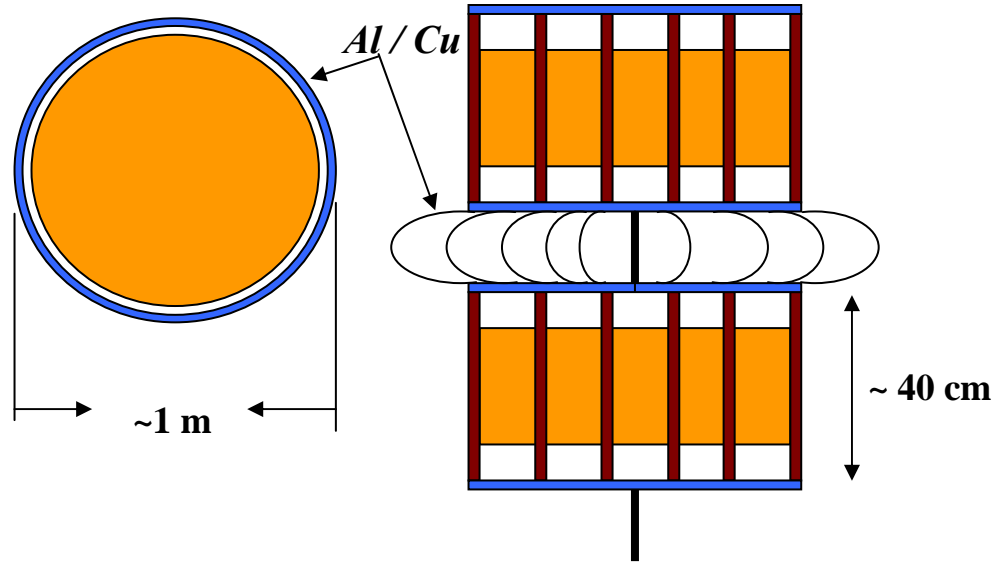



# Performed Test

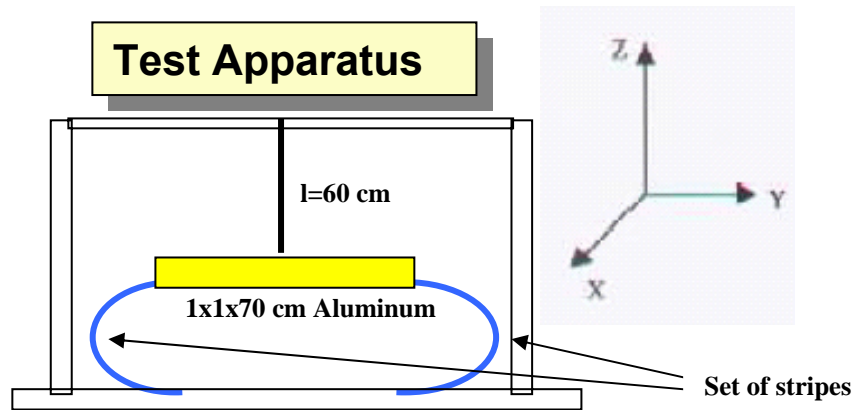

|                      |                                 |
|----------------------|---------------------------------|
| 1) Parallel to Y     | $K_Y = 2,4\text{ N/m}$          |
| 2) Parallel to X     | $K_X = 11,4\text{ N/m}$         |
| 3) Rotation around Z | $K_{\theta Z} = 3,5\text{ N/m}$ |
| 4) Rotation around X | $K_{\theta X} = 3,0\text{ N/m}$ |

- Negligible stiffness, negligible effects on Q (measured)
- Enough thermal conductivity at 4 K (on paper)



# Problems with PT Vibrations

- Pulse Tubes seem to be very promising cryo-coolers, but some problems need to be solved for future implementations on real cryogenic detectors.
- Even if they have no moving part in the cold heat exchanger there is evidence of an excess noise from vibrations of the rotary valve into the cold head.
- At the moment a different technological solution foresees this rotary valve out of the cold head, with considerable reduction of vibrations (Sumitomo PT).

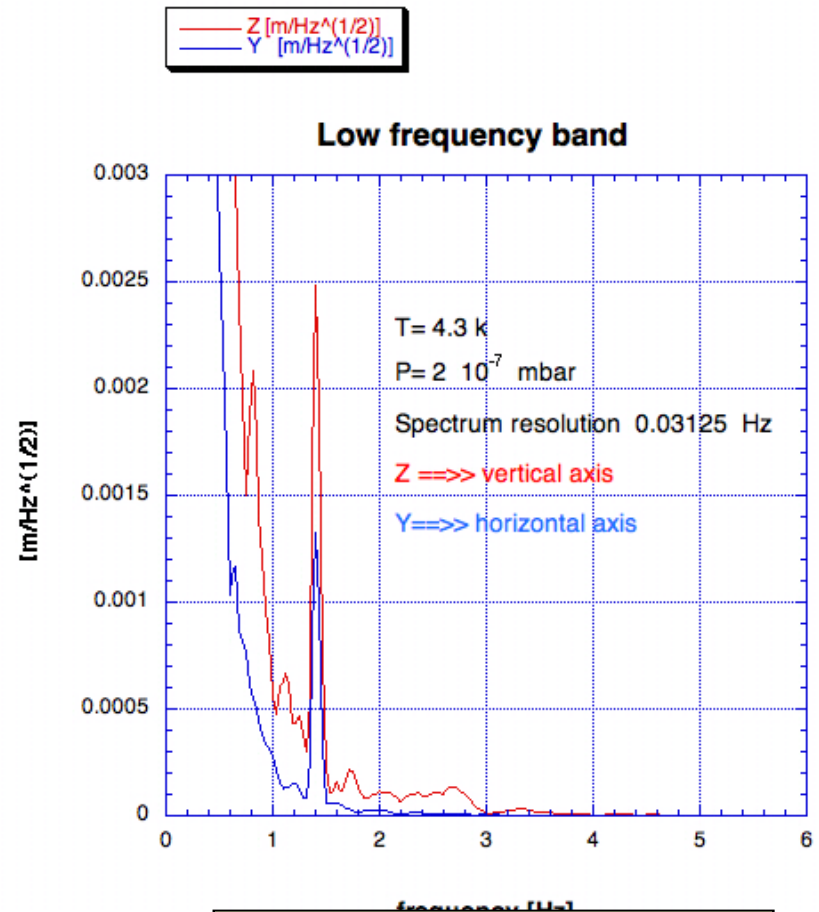

Fulvio Ricci I<sup>o</sup> ILIAS-STREGAmeeting

# *The Roma Group Vibration Free Cryostat*

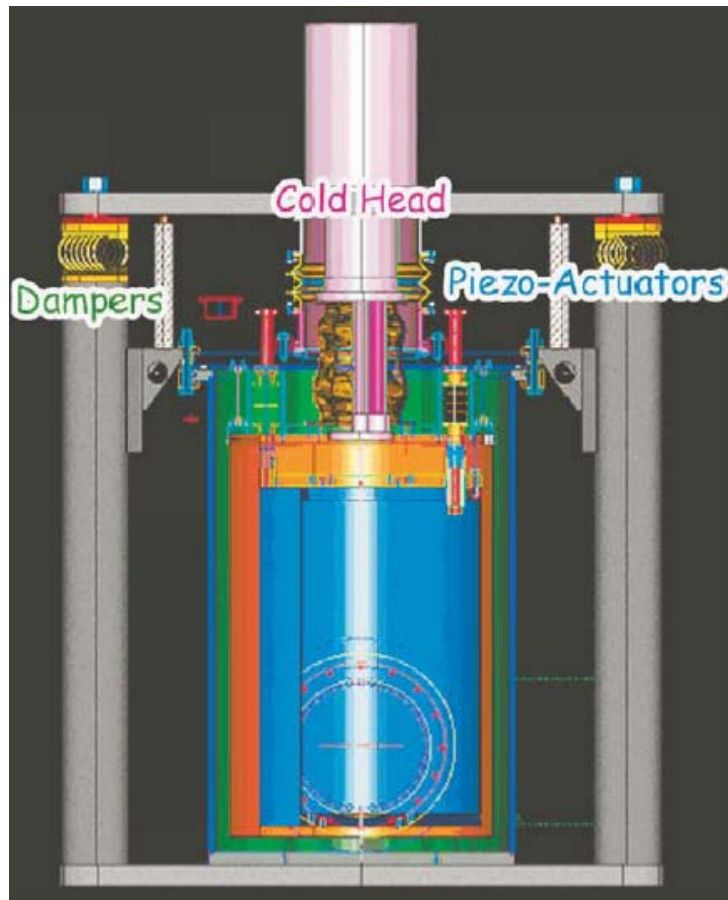

**INFN of Roma**  
**Roma University**



*Roberto Passaquieti - Gingin, 6<sup>th</sup> October 2005*