

High Frequency Parametric Instabilities in AdvLIGO and Methods for their Control

David Blair, Chunnong Zhao, Ju Li, Slawomir
Gras, Pablo Barriga and Jerome Degallaix

LIGO-G050193-00-Z

ACIGA, University of Western Australia

PRL In press

Parametric instabilities and their control in advanced interferometer GW detectors

C. Zhao, L. Ju, J. Degallaix, S. Gras, and D. G. Blair

School of Physics, the University of Western Australia, 35 Stirling Highway, Nedlands, WA 6009

A detailed simulation of Advanced LIGO test mass optical cavities shows that parametric instabilities will excite acoustic modes in the test masses in the frequency range 28-35 kHz and 64-72 kHz. Using nominal Advanced LIGO optical cavity parameters with fused silica test masses, parametric instability excites 7 acoustic modes in each test mass, with parametric gain R up to 7. For the alternative sapphire test masses only 1 acoustic mode is excited in each test mass with $R \sim 2$. Fine tuning of the test mass radii of curvature cause the instabilities to sweep through various modes with R as high as ~ 2000 . Sapphire test mass cavities can be tuned to completely eliminate instabilities using thermal g-factor tuning with negligible degradation of the noise performance. In the case of fused silica test mass, instabilities can be minimized but not eliminated.

Control Issues

When energy densities get high things go unstable...

- intrinsic coherent scattering
- acoustic gain like a laser gain medium
- akin to SBS
- observed and controlled in NIOBE
- not control system feedback instability!

Photon-Phonon Scattering

up-conversion

down-conversion

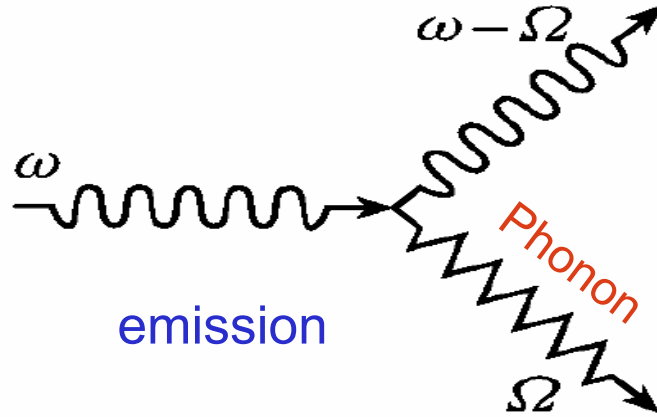
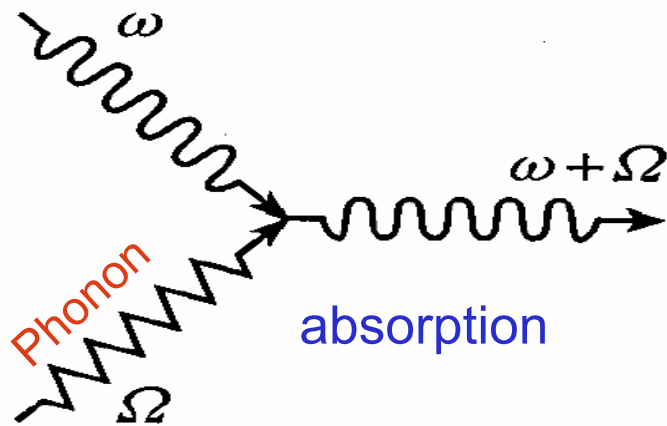

Instabilities from photon-phonon scattering.

- A test mass phonon can be **absorbed** by the photon, increasing the photon energy, (damping)
- The photon can **emit** the phonon, decreasing the photon energy. (potential acoustic instability)

Two Types of Parametric Instability

- **Low Frequency: Phonon frequency is within the optical cavity bandwidth**
 - optical spring effects affecting control and locking of suspended test masses
 - tranquilliser cavity to suppress high frequency instabilities
- **High Frequency: Phonon frequency outside optical cavity bandwidth**
 - only possible if appropriate Stokes modes exist.

Schematic of HF Parametric Instability

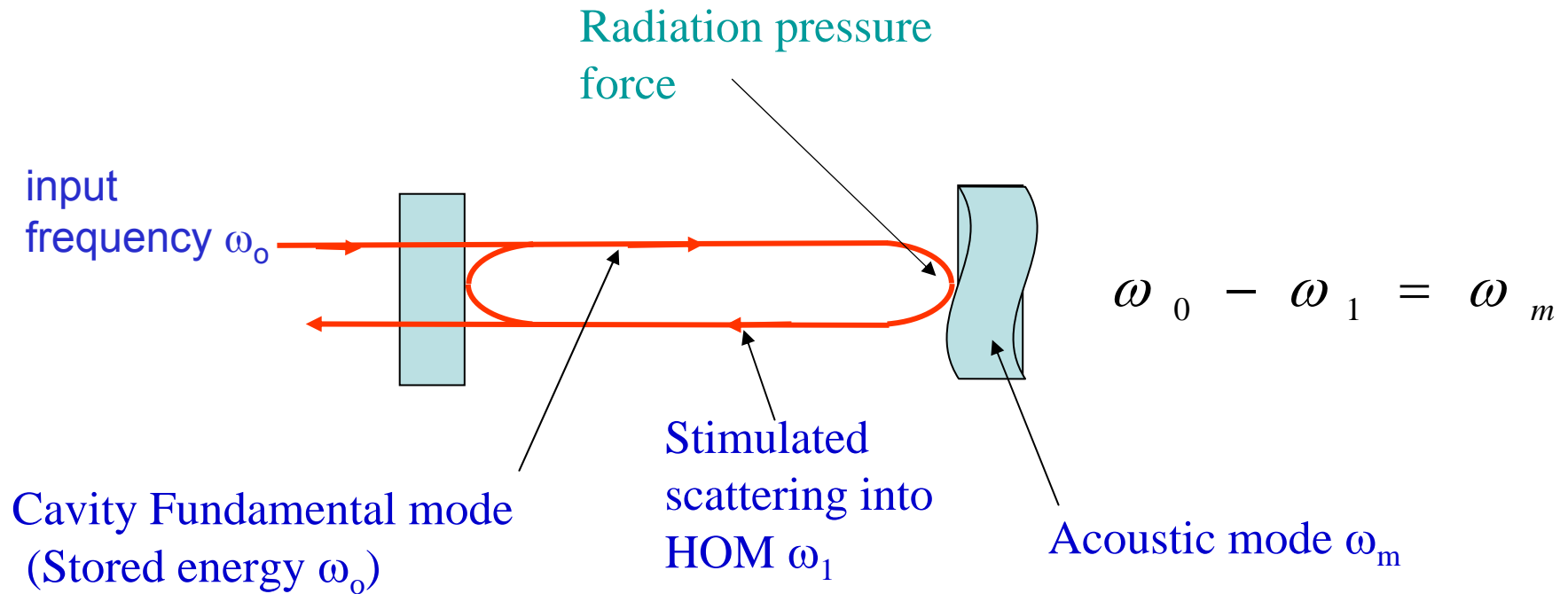

Overlap factor

Parametric Gain

$$R = \frac{R_0 \Lambda}{1 + \Delta\omega^2 / \delta_1^2} > 1$$

Half bandwidth of the optical mode

Optical Q-factor

Mechanical Q-factor

$$R_0 = \frac{4P_0 Q_0 Q_m}{mc\omega_m^2}$$

$$\Delta\omega = \omega_0 - \omega_m - \omega_1$$

Fundamental mode frequency

Acoustic mode frequency

High order transverse mode frequency

High circulating power
 High optical and mechanical Q
 High overlap factor
 $\Delta\omega$ small, $\Lambda > 0$



$R > 1$,
 Instabilities

Instability Requirements

- Frequency Coincidence
- Mode Shape Overlap Λ

Mode Density, Sapphire and Silica

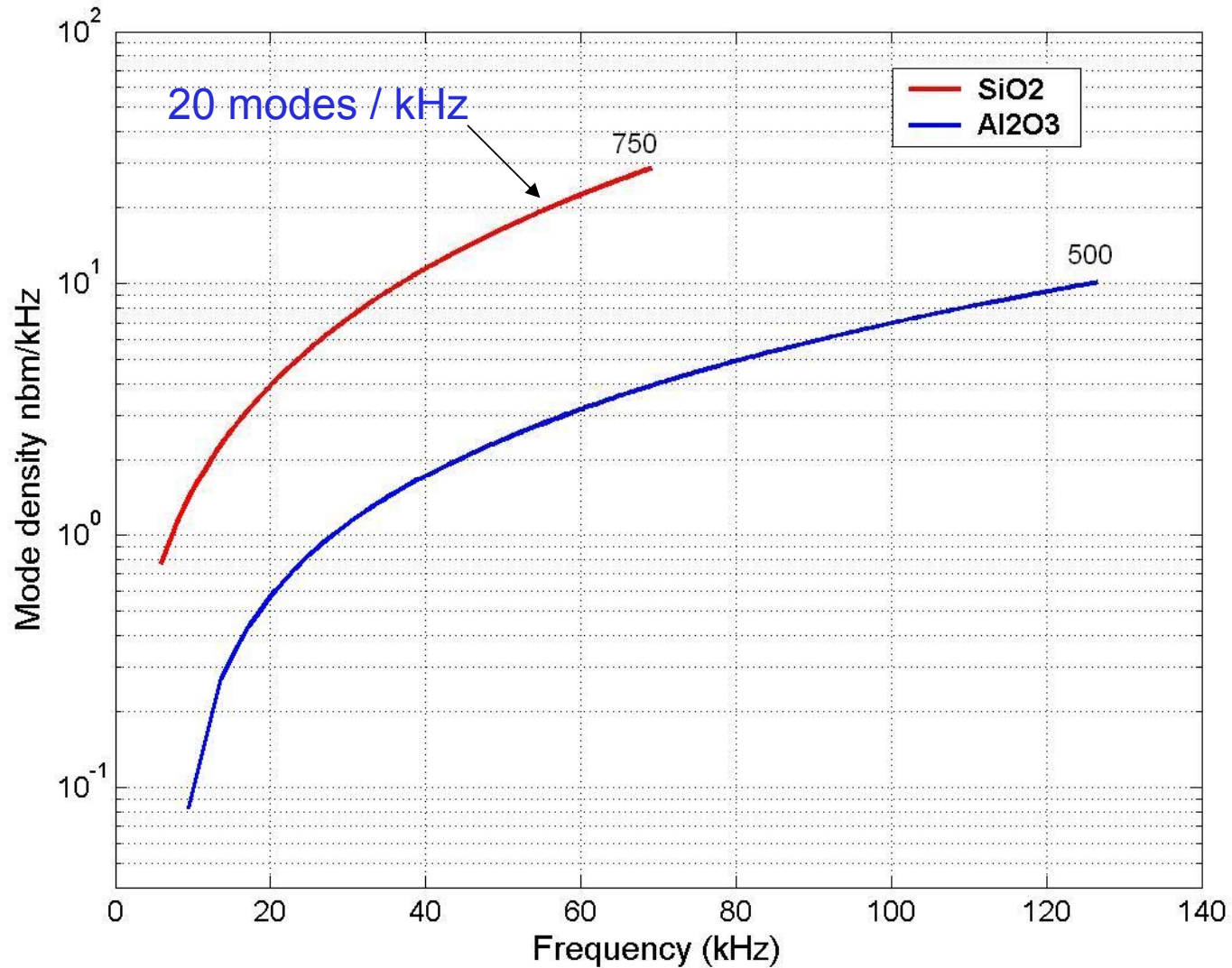

750/500 – the total number of modes at the end of the plot

Mode Structure for Advanced LIGO

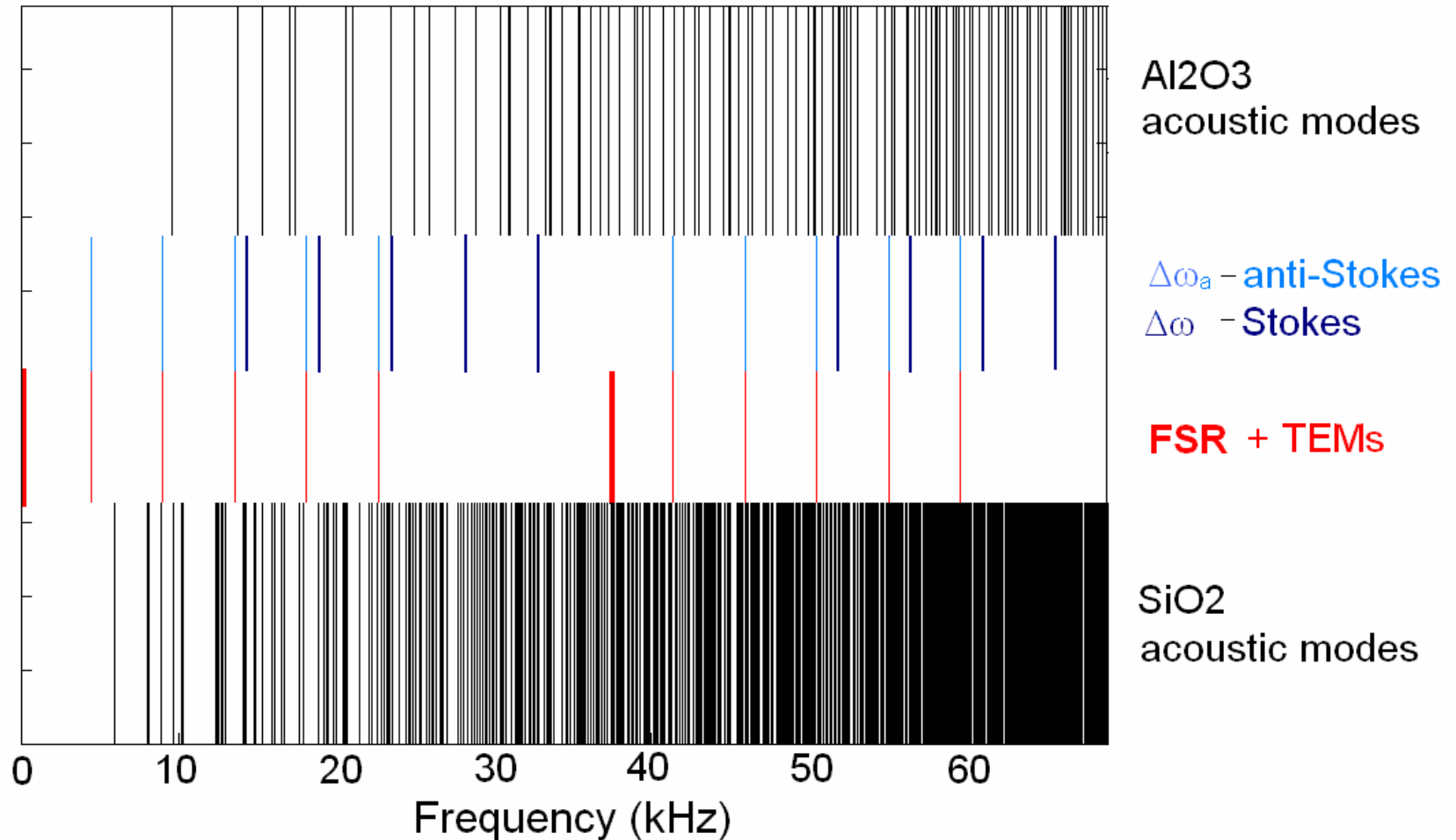

If $\Delta\omega - \omega_m < \text{optical linewidth}$ resonance condition may be obtained
 $\Delta\omega = (n \cdot \text{FSR} - \text{TEM}_{mn})$ - frequency difference between the main and Stokes/anti-Stokes modes
 ω_m - acoustic mode frequency, δ - relaxation rate of TEM

Example of acoustic and optical modes for Al2O3 AdvLIGO

44.663 kHz

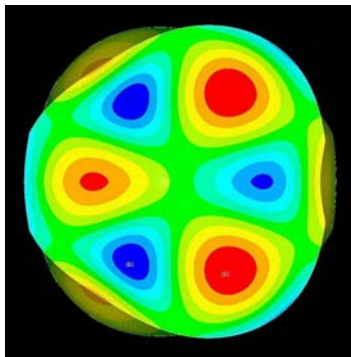

47.276 kHz

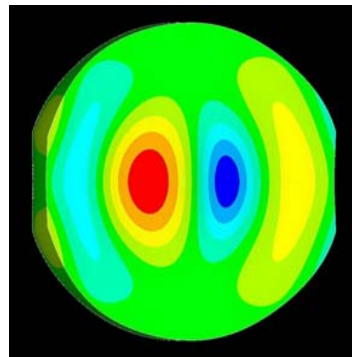

89.450kHz

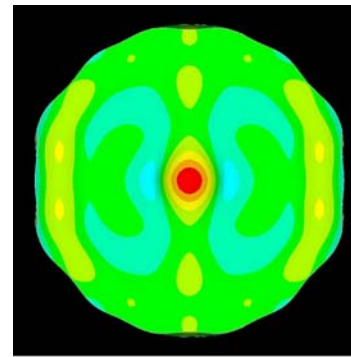

acoustic mode

HGM12

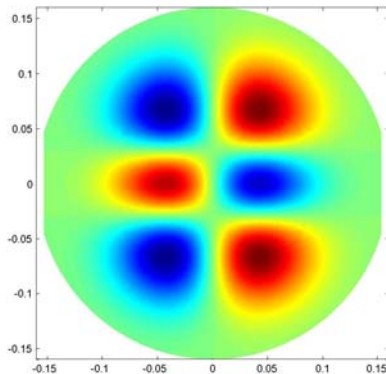

HGM30

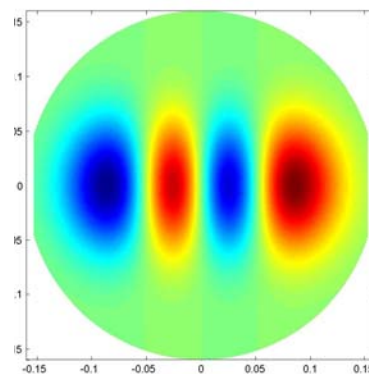

LGM20

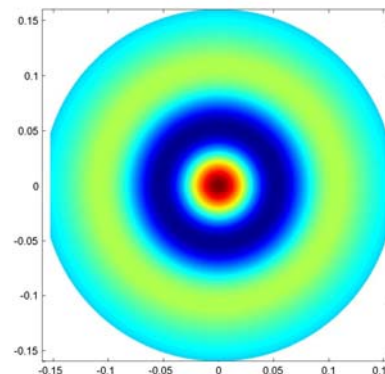

optical mode

Λ

0.203

0.800

0.607

Λ overlapping parameter

If $\Lambda > 10^{-4}$ and $\Delta\omega - \omega_m = 0$, $R > 1$ for AdvLIGO

Original AdvLIGO design

HOM $\Delta f = 4.6 \text{ kHz}$

$$R = 54416 \text{ m}$$

$$g_{\text{mirrors}} = 0.926$$

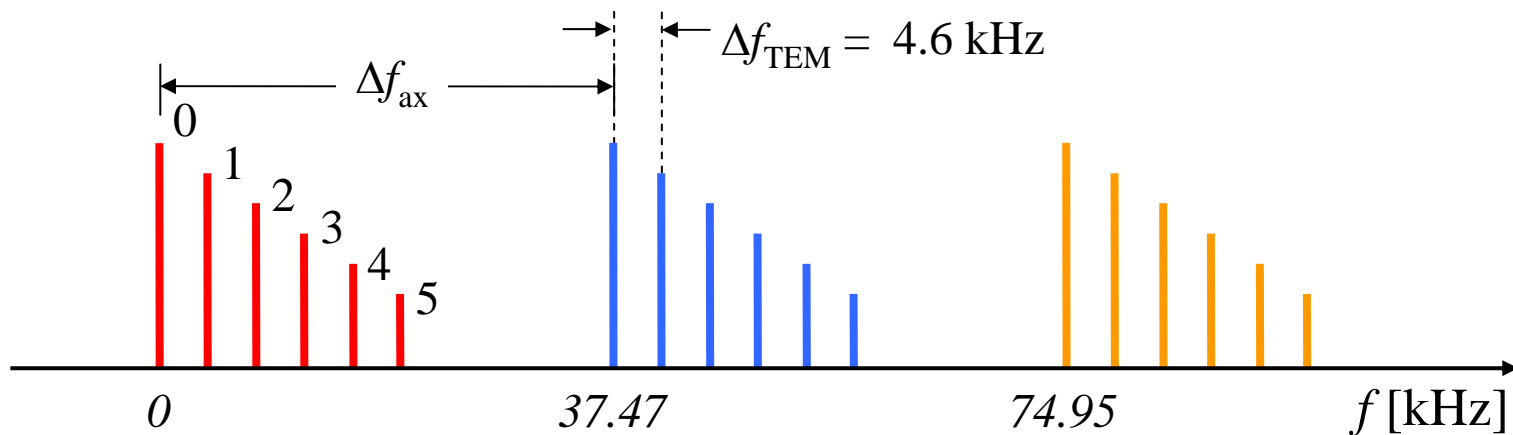

HOM not symmetric: Upconversion or down conversion occur separately. Down conversion always potentially unstable.

Adv LIGO Nominal parameters

HOM $\Delta f = 4.6 \text{ kHz}$

$$R = 2076.5 \text{ m}$$

$$g_{\text{mirrors}} = -0.926$$

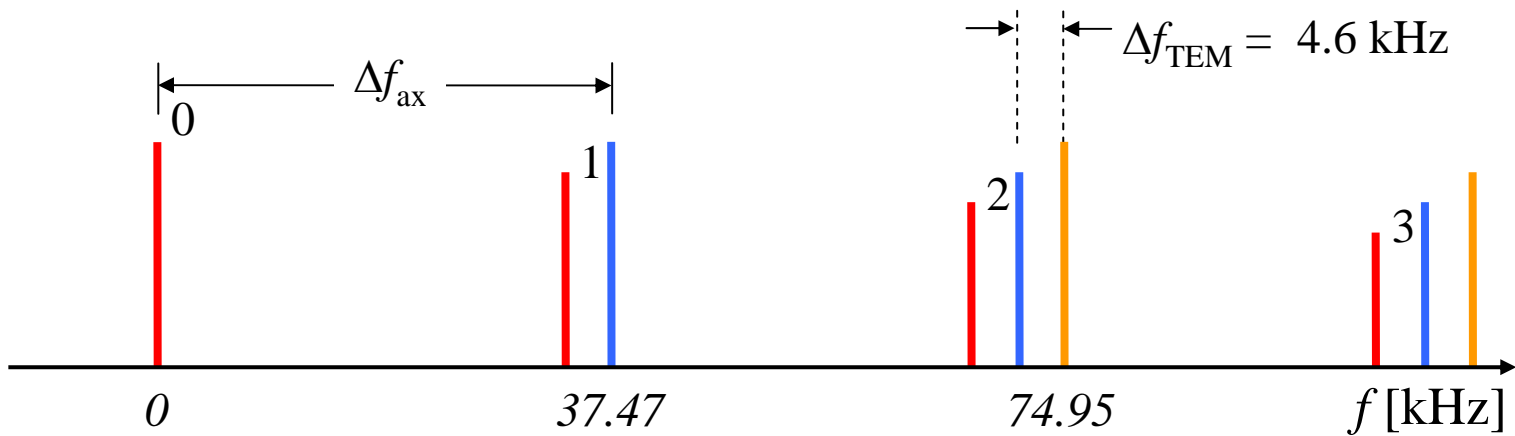

Is there a better choice of g-factor?

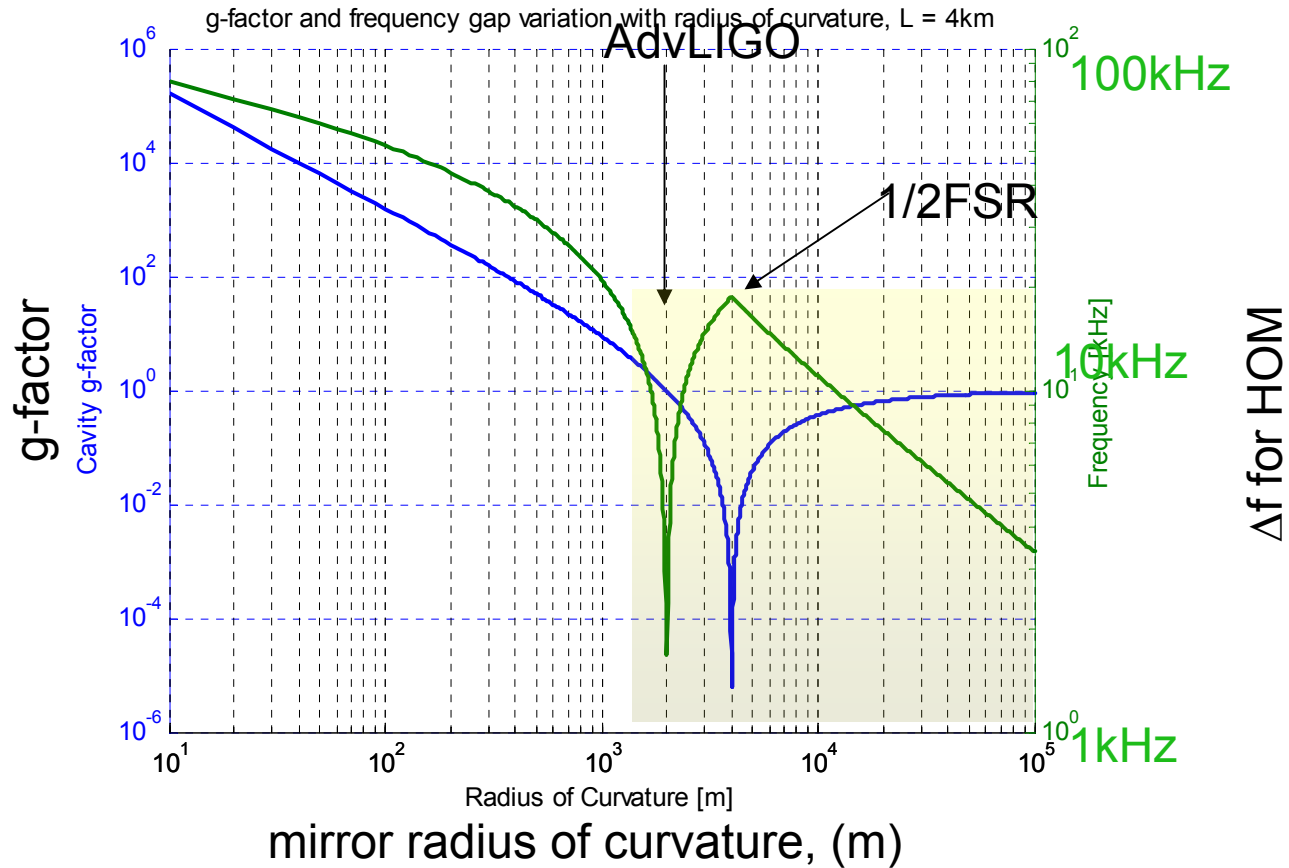

Comparison of Instabilities in Fused Silica and Sapphire

Silica has ~ 7 times more unstable modes, worse instability gain

Fine ROC tuning can reduce problem

AdvLIGO near current design

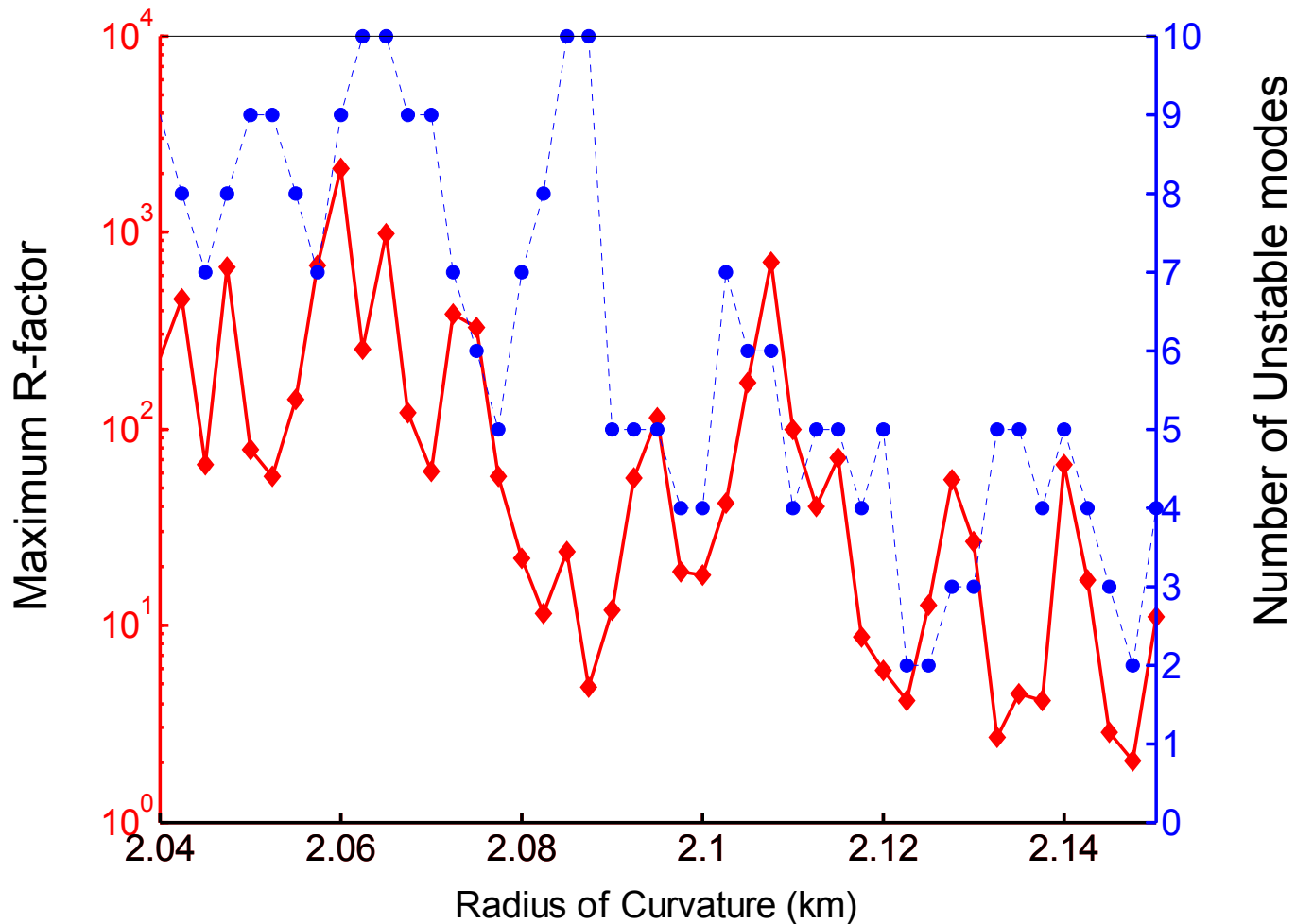

The maximum R of all acoustic modes (red) and number of acoustic modes ($R > 1$, blue) as a function of mirror radius of curvature for fused silica.

AdvLIGO Long ROC Design

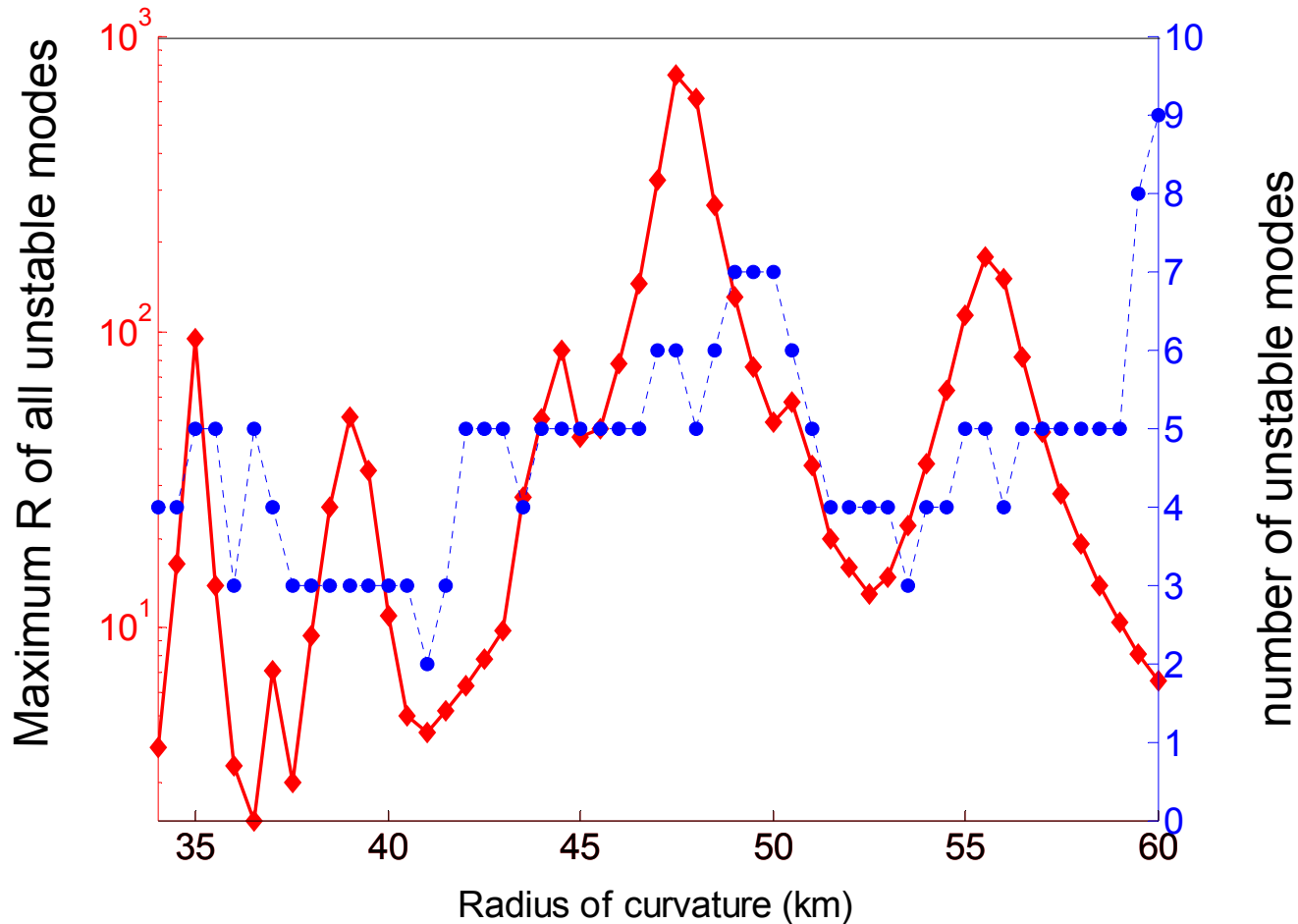

The maximum R of all acoustic modes (red) and number of acoustic modes ($R > 1$, blue) as a function of mirror radius of curvature for fused silica

AdvLIGO Near Current for Sapphire

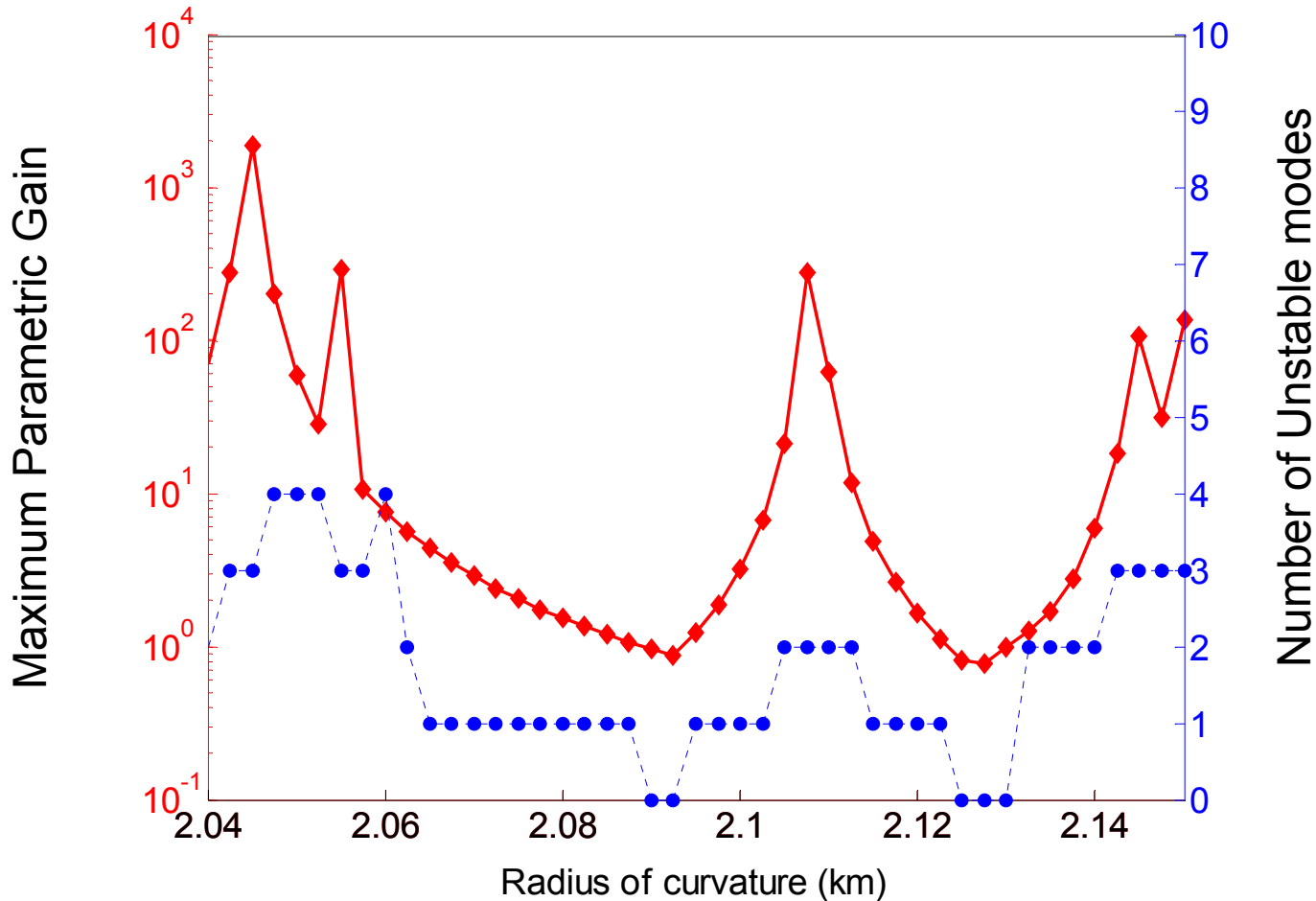

The maximum R of all acoustic modes (red) and number of acoustic modes ($R > 1$, blue) as a function of mirror radius of curvature for sapphire

AdvLIGO Long ROC Design, sapphire

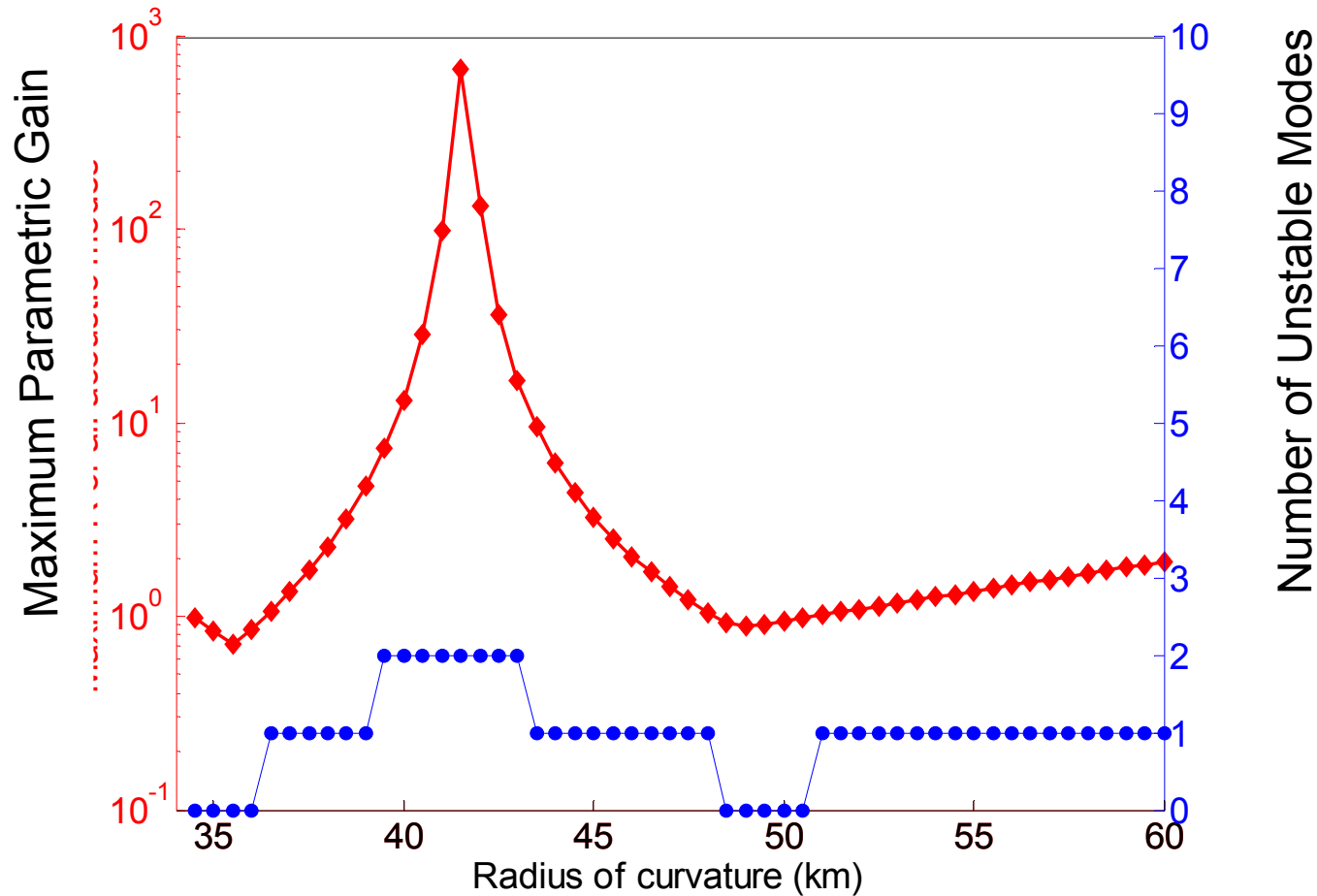

The maximum R of all acoustic modes (red) and number of acoustic modes ($R > 1$, blue) as a function of mirror radius of curvature for sapphire.

ETM radius of curvature vs heating

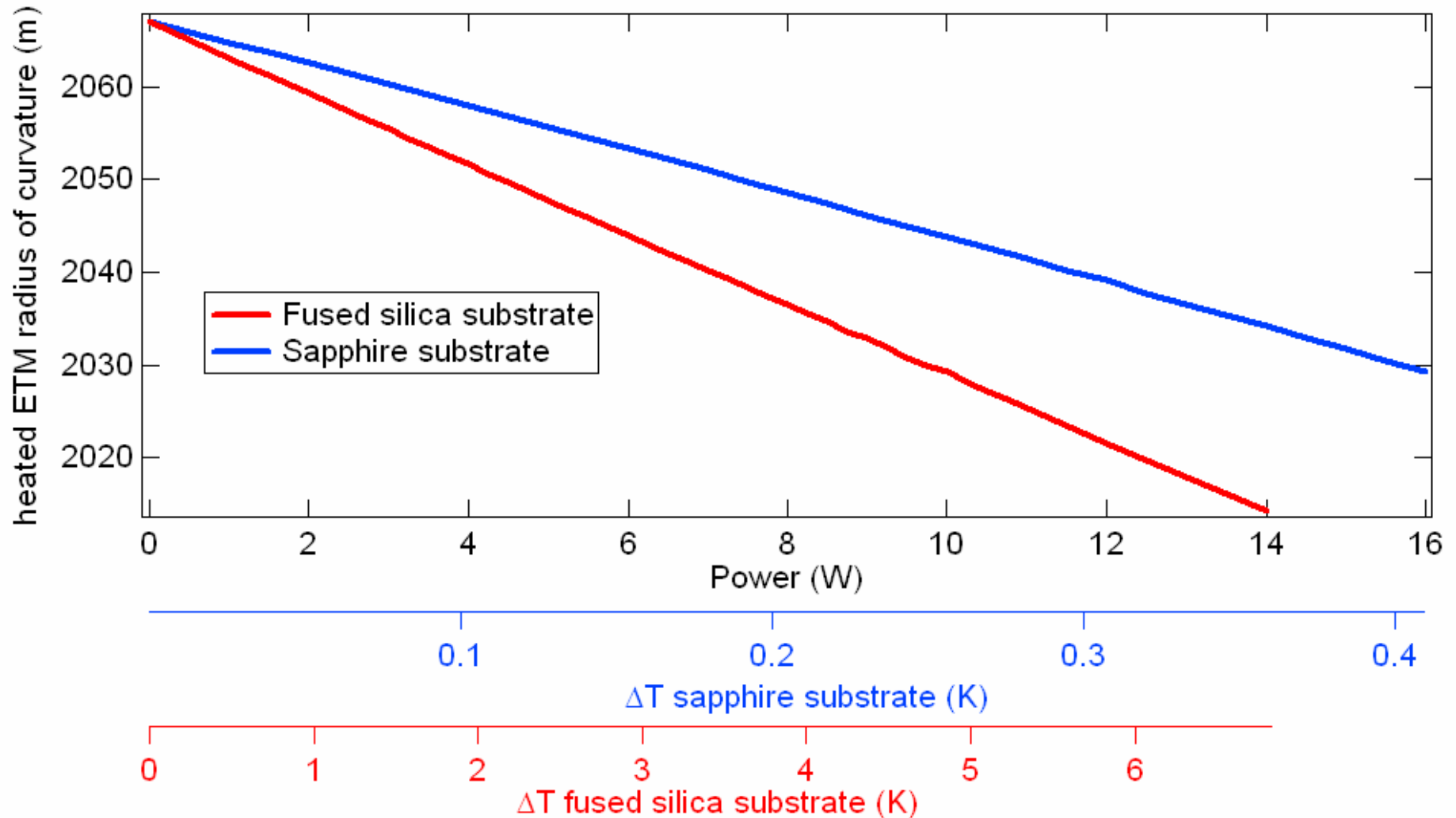

Thermal Tuning of ROC and Parametric Gain, Sapphire

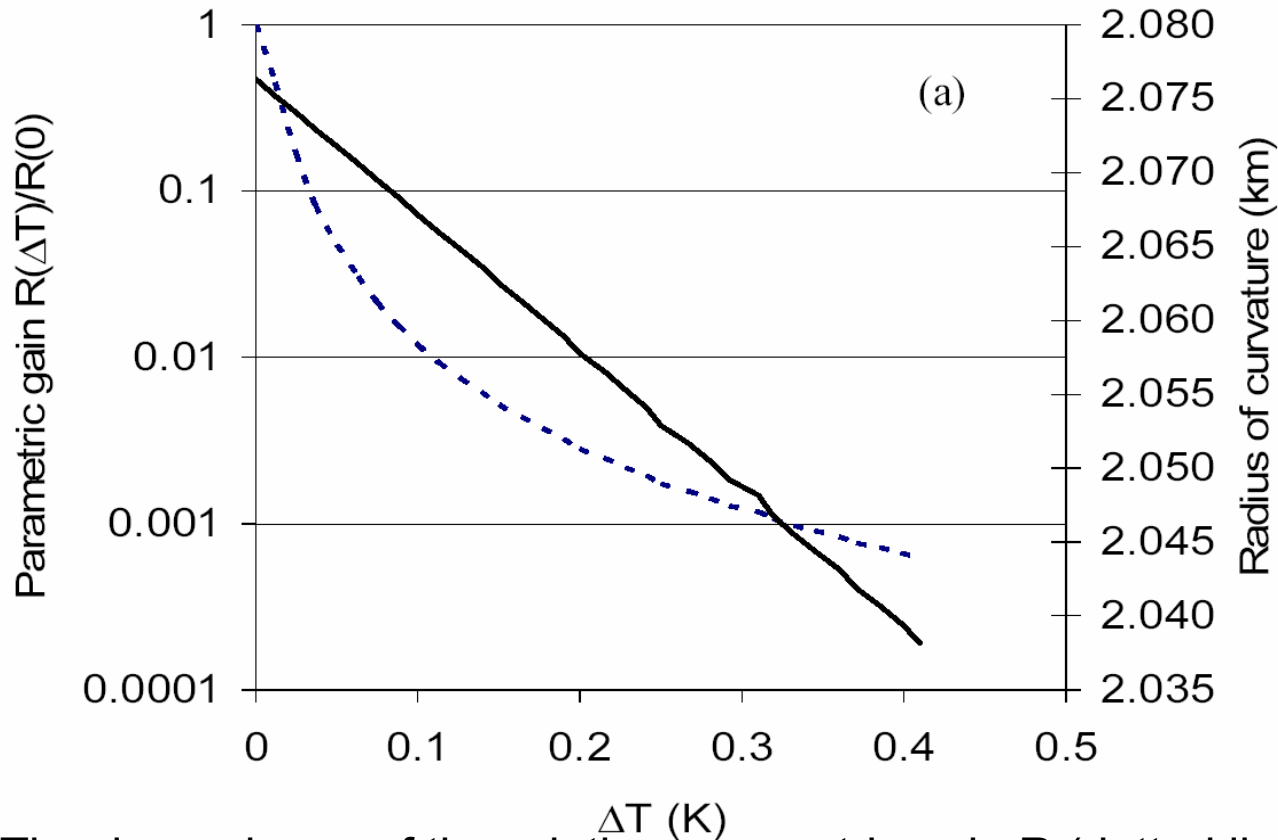

The dependence of the relative parametric gain R (dotted line) and the mirror radius of curvature (solid line) on the maximum temperature difference across the test mass if considering only one acoustic mode, for sapphire

Unfortunately many acoustic modes mean cannot achieve such reduction

Thermal Tuning of Parametric Gain and ROC, Fused Silica

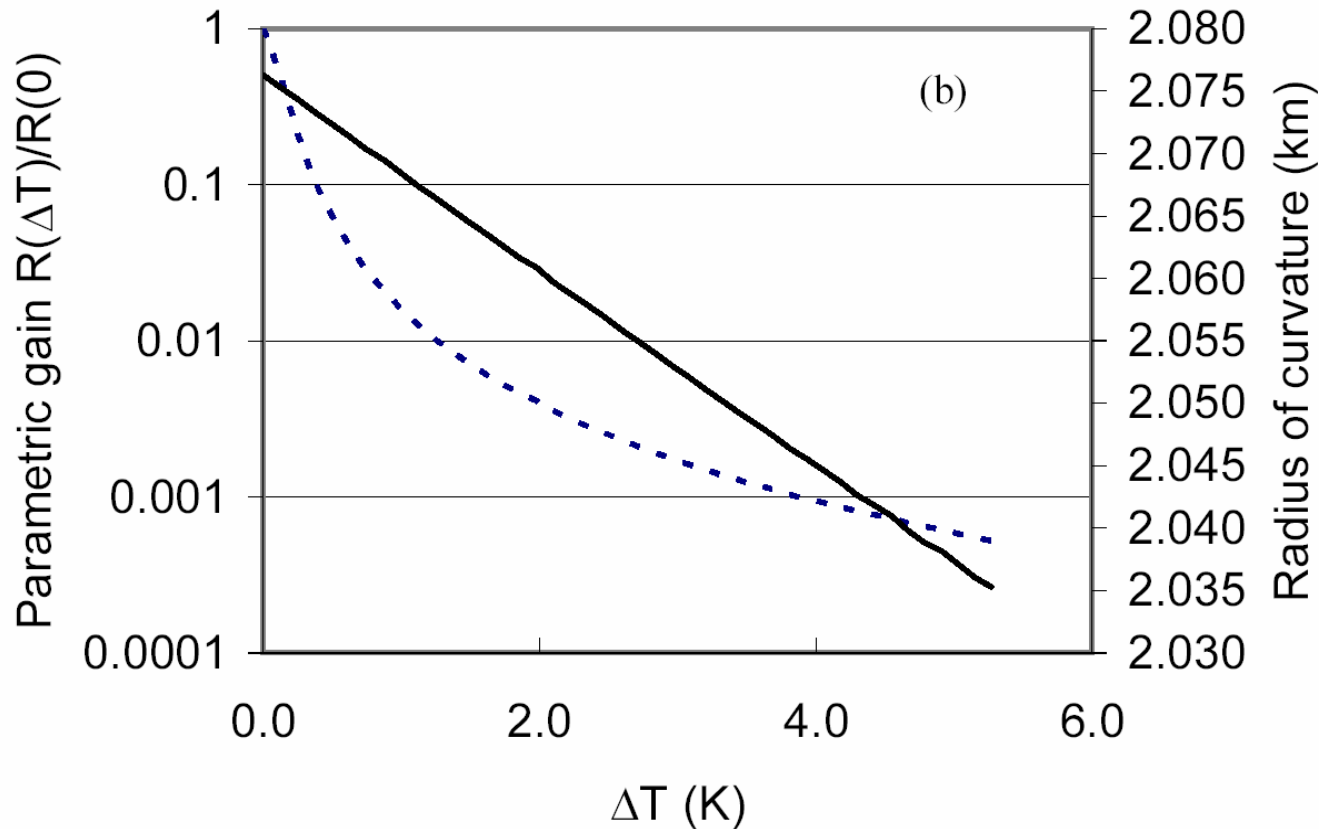

The dependence of the relative parametric gain R (dotted line) and the mirror radius of curvature (solid line) on the maximum temperature difference across the test mass if considering only one acoustic mode, for fused silica

Conclusion so Far

- Parametric instability is inevitable
- Can be minimised by thermal tuning
- Fused Silica has many more unstable modes
- Best case 2 modes per test mass, $R \sim 10$
- Typical case (at switch on...and remember thermal lensing is changing R dynamically after switch on): $R \sim 100$, 7-10 modes per test mass) 30-40 modes in all.
- Is it possible to thermally tune to minimum before all hell breaks out?

Instability Control

- Thermal tuning to minimise gain
 - complete control for sapphire, reduction for fused silica
- Gain Reduction by Mechanical Q-Reduction
 - Apply surface losses to reduce Q without degrading thermal noise
- Tranquilisation with separate optical system
 - Direct radiation pressure with walk-off beam
 - tranquiliser cavity (short cavity parametric stabiliser)
 - capacitive local control feedback
- Re-injection of phase shifted HOM
 - Needs external optics only

Is power loss from ETM tuning a problem?

- Power loss reasonably small c/w PRC transmission loss
- Arm cavity power loss due to mode mismatching less than $\sim 0.5\%$
(arm cavity only, not coupled with the power recycling cavity)
- This results is to compared with the transmission of the PRC mirror 0.06

Less than 1% Power Loss due to Mode Mismatches if ETM is Tuned

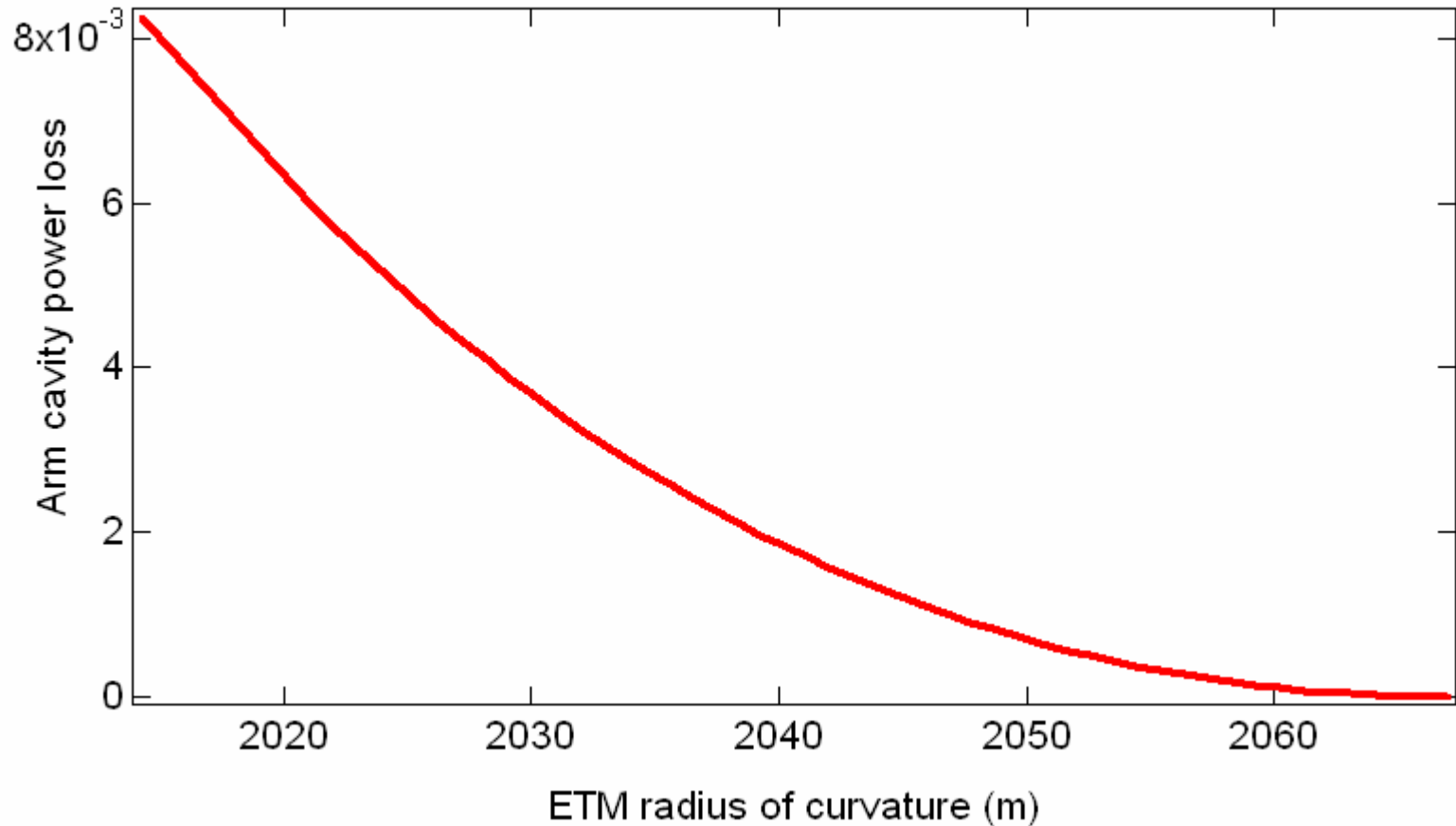

Mirror thermal tuning : Sapphire Fast c/w Silica

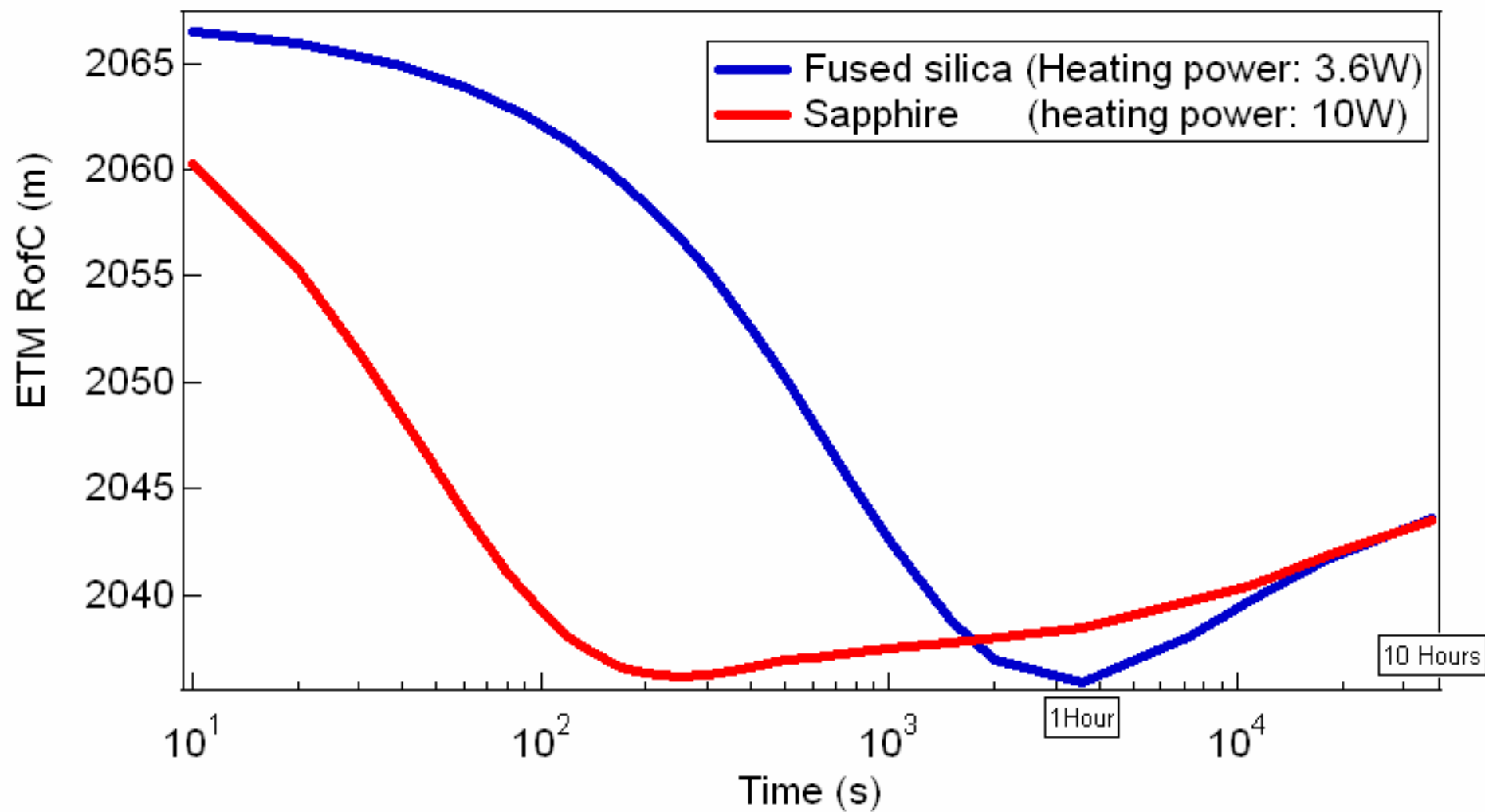

Mirror deformation evolution for different heating pattern

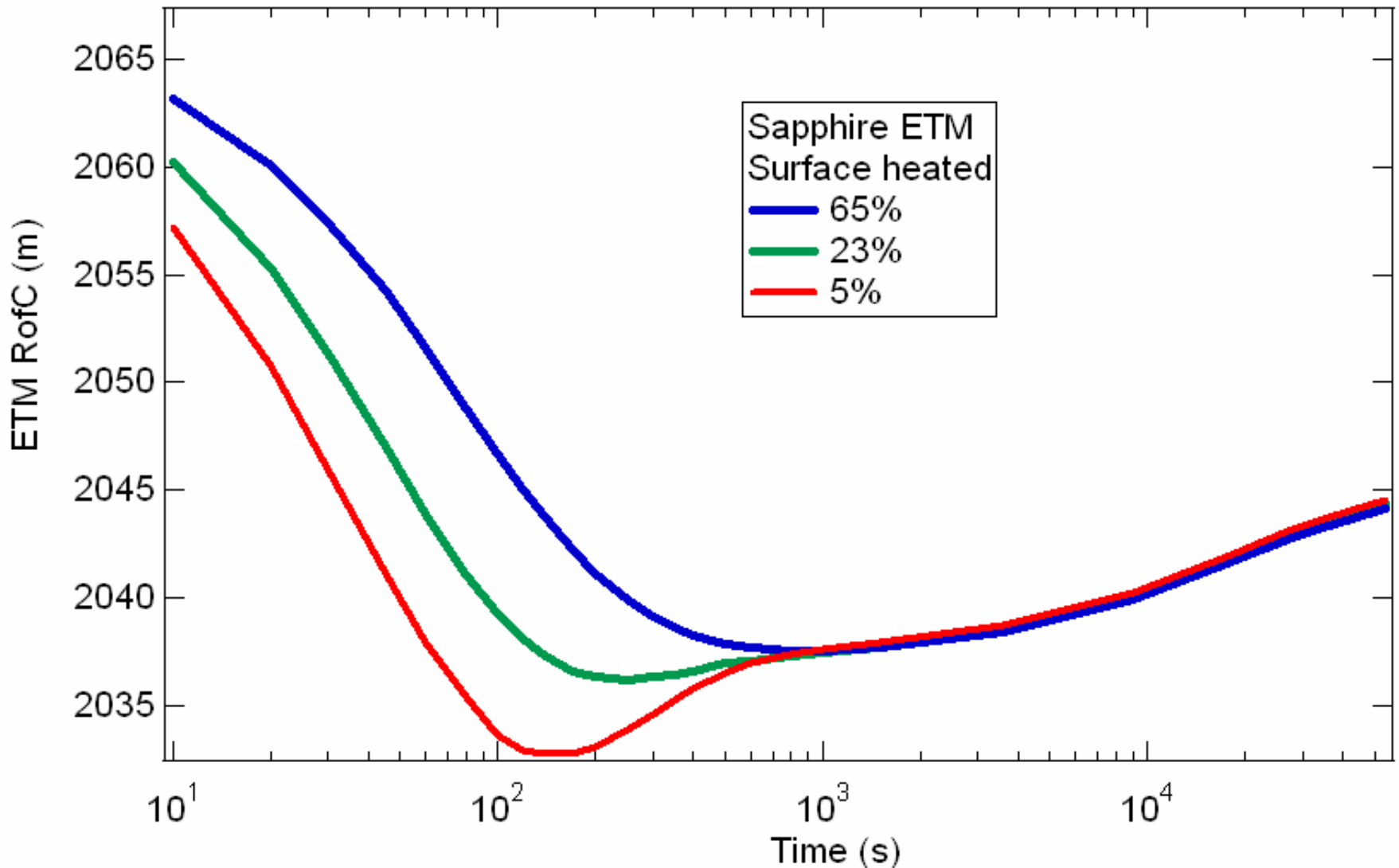

Instability Ring-Up Time

For $R > 1$, Ring-up time constant is $\sim \tau_m/(R-1)$

Time to ring from thermal amplitude to cavity position bandwidth (10^{-14} m to 10^{-9} m is

$$\sim 140\tau_m/R \sim 100-1000 \text{ sec.}$$

Interferometer lock will be broken for amplitudes greater than position bandwidth.

To prevent breaking of interferometer lock cavities must be controlled within ~ 100 seconds

Instability Control

- Thermal tuning to minimise gain
 - complete control for sapphire, reduction for fused silica
- **Gain Reduction by Mechanical Q-Reduction**
 - **Apply surface losses to reduce Q without degrading thermal noise**
- Tranquilisation with separate optical system
 - Direct radiation pressure with walk-off beam
 - tranquiliser cavity (short cavity parametric stabiliser)
 - capacitive local control
- Re-injection of phase shifted HOM
 - Needs external optics only

Apply a surface loss layer on edge of test mass

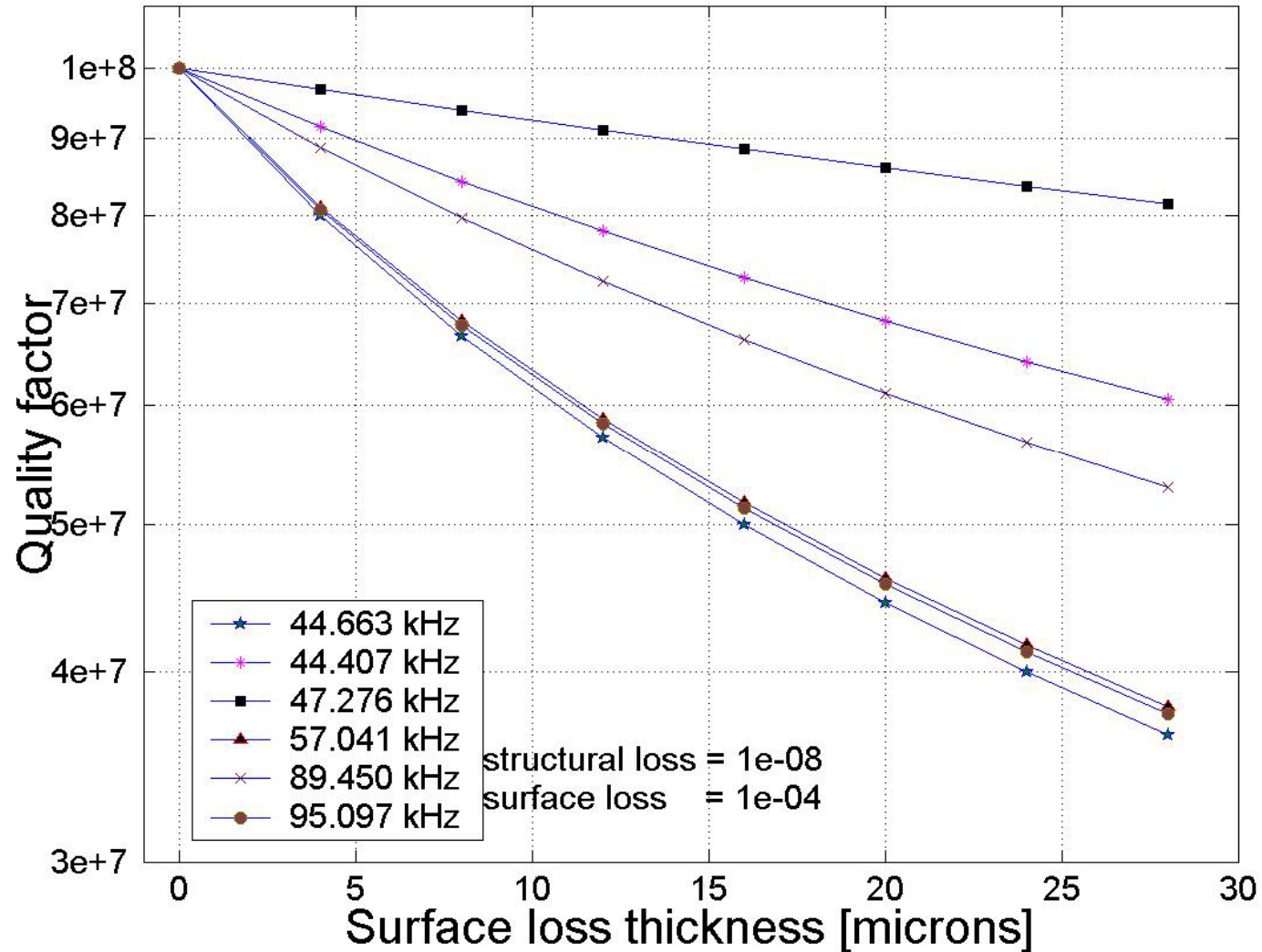

AdvLIGO Sapphire

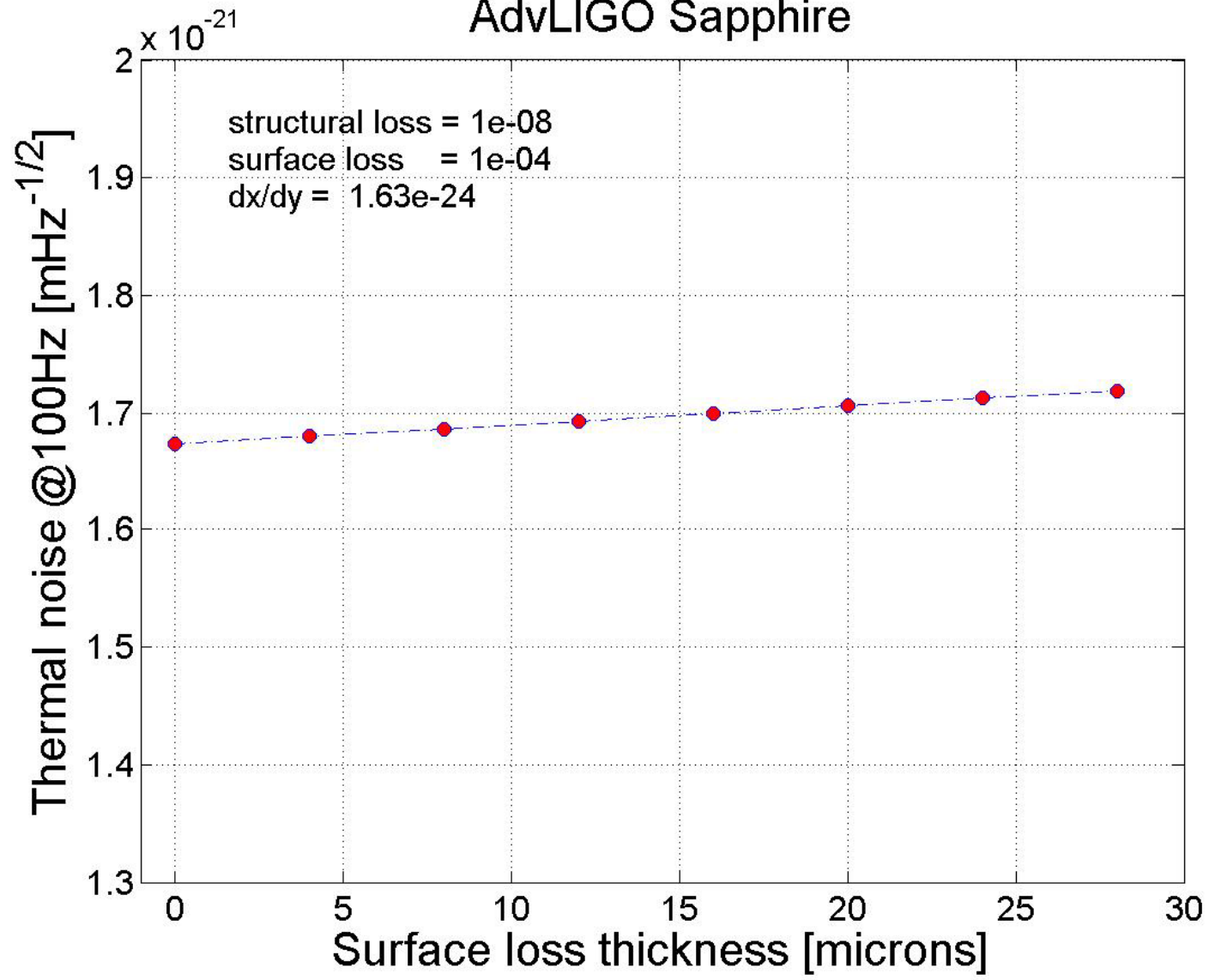

AdvLIGO F.Silica

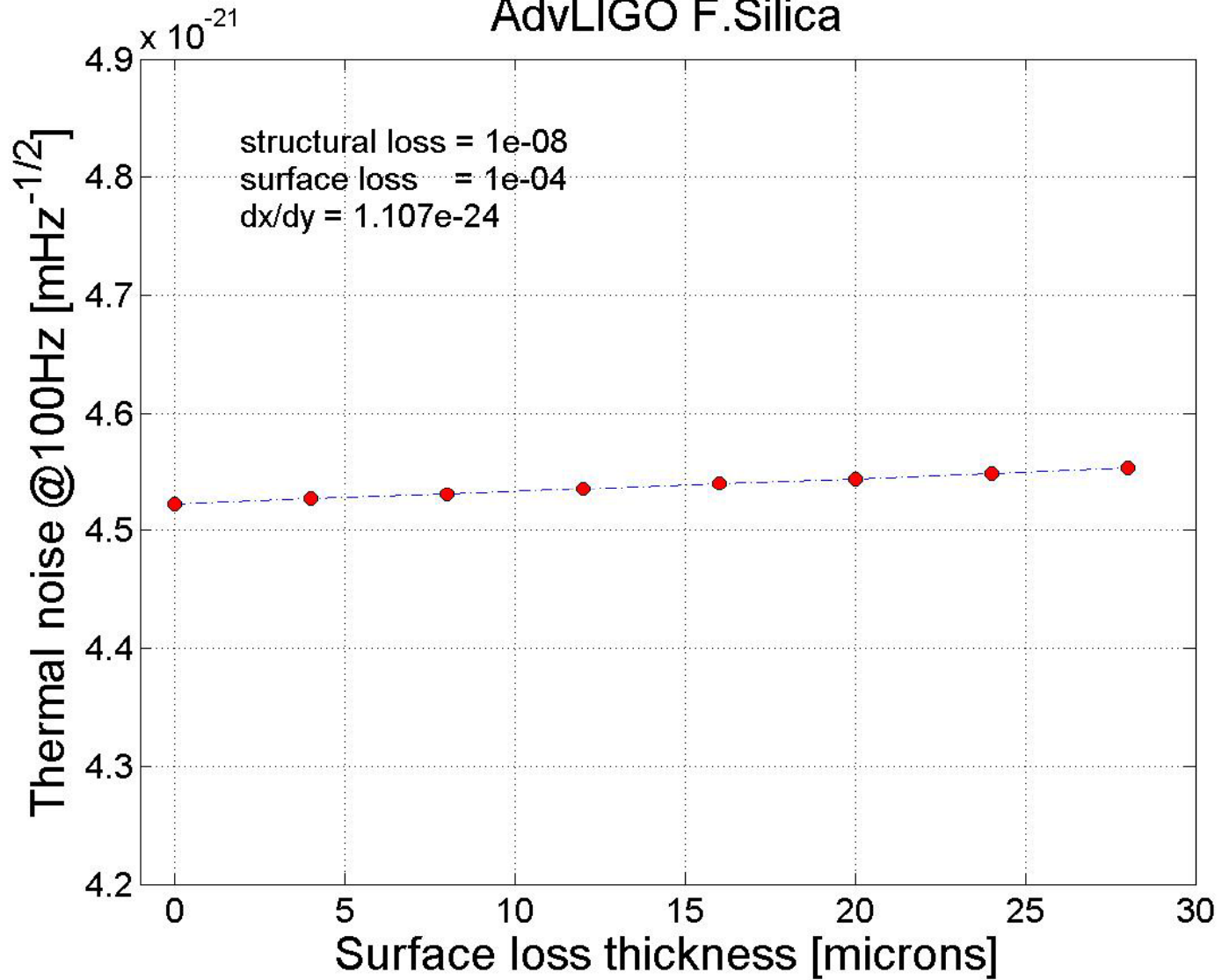

Quality factor Reduction is Mode Dependent

Quality Factor vs surface loss angle for AdvLIGO Al₂O₃ test mass

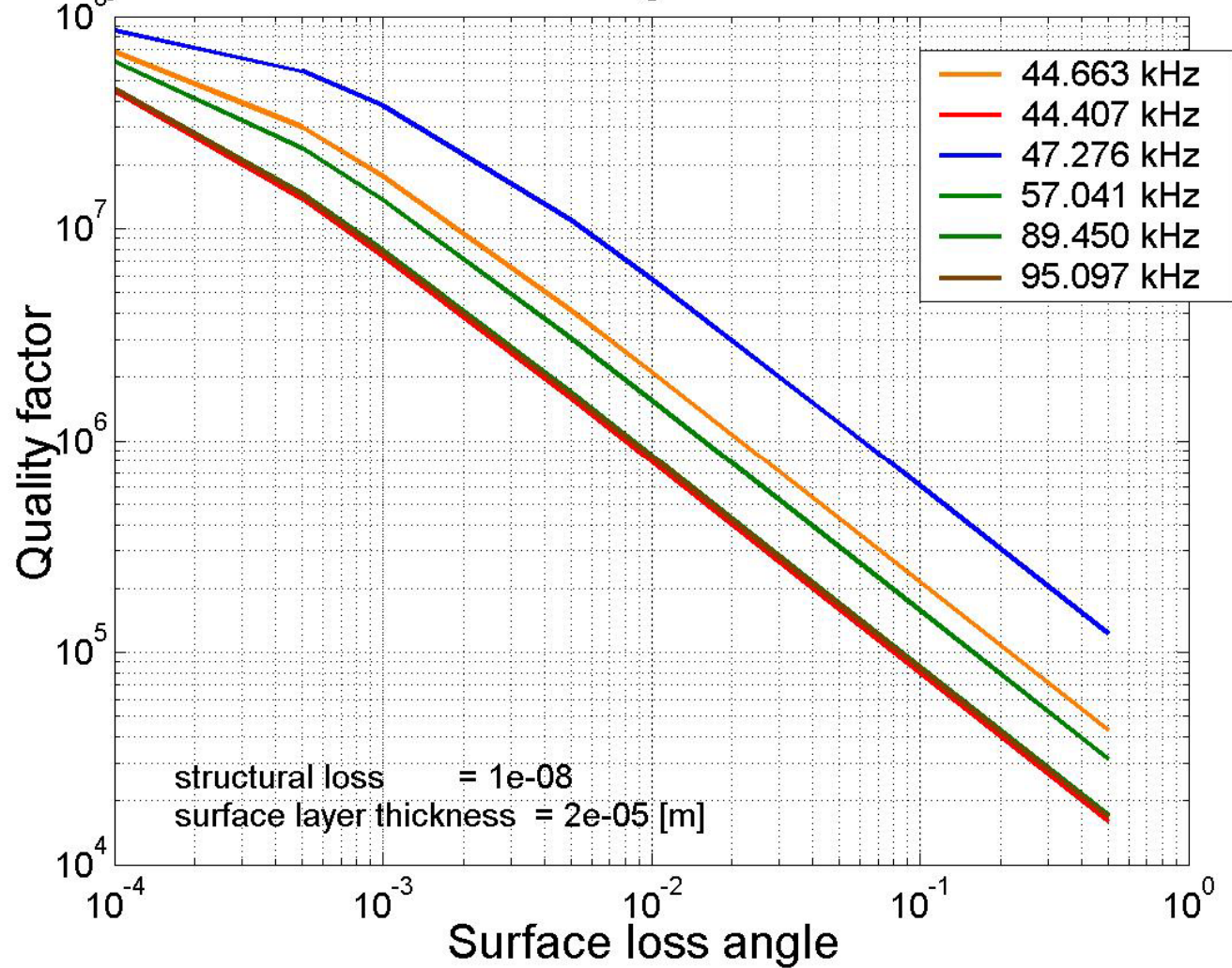

Thermal Noise Contribution (no coating losses)

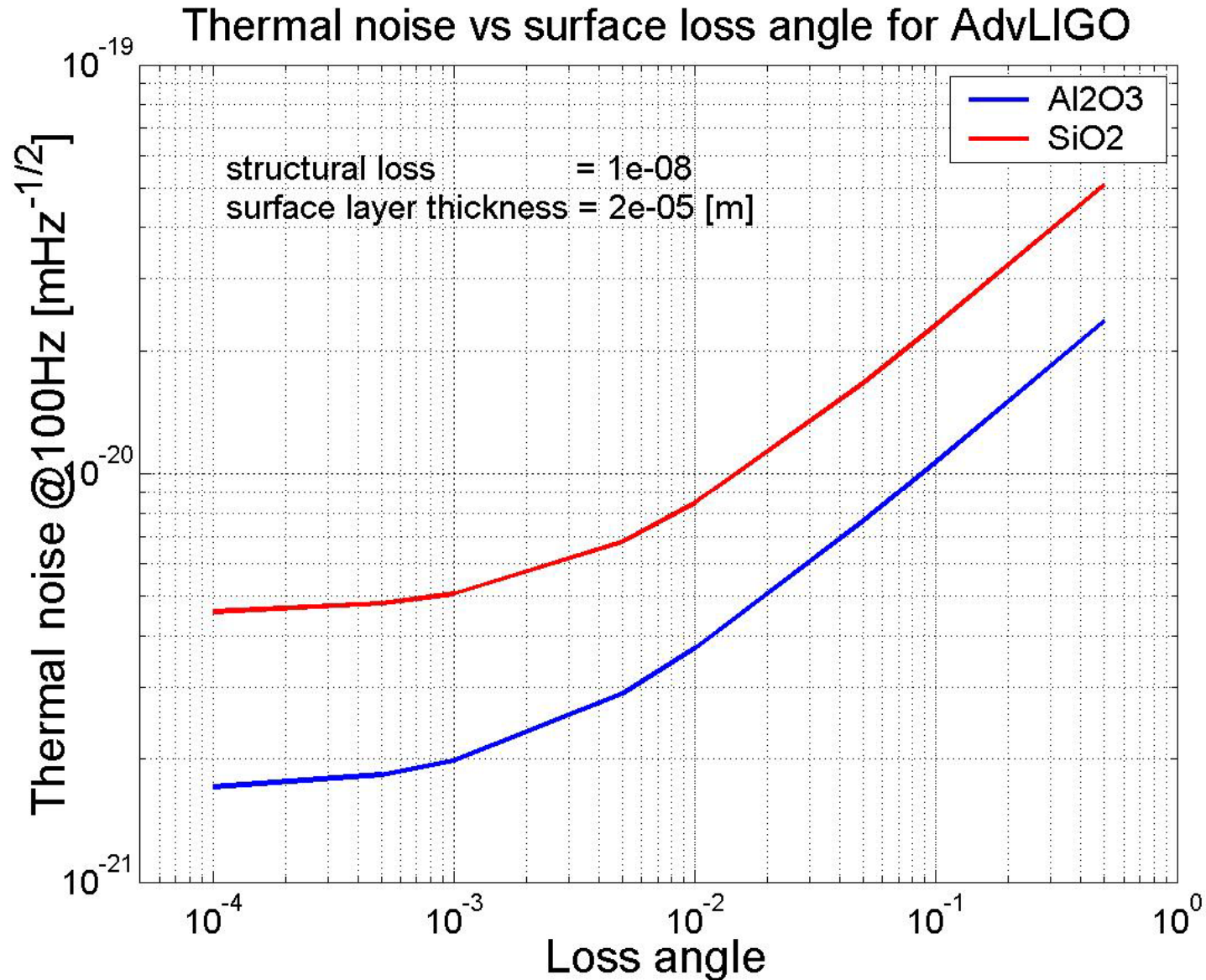

Instability Control By Direct Injection Cold Damping

No Internal Components

HOM Mode Matching
needs to be modelled

Direct Cold Damping by Feedback of HOM Signal

- HOM signal can by definition transmit in arm cavity
- HOM signal is also transmitted by PRC because it has a linewidth of \sim MHz.

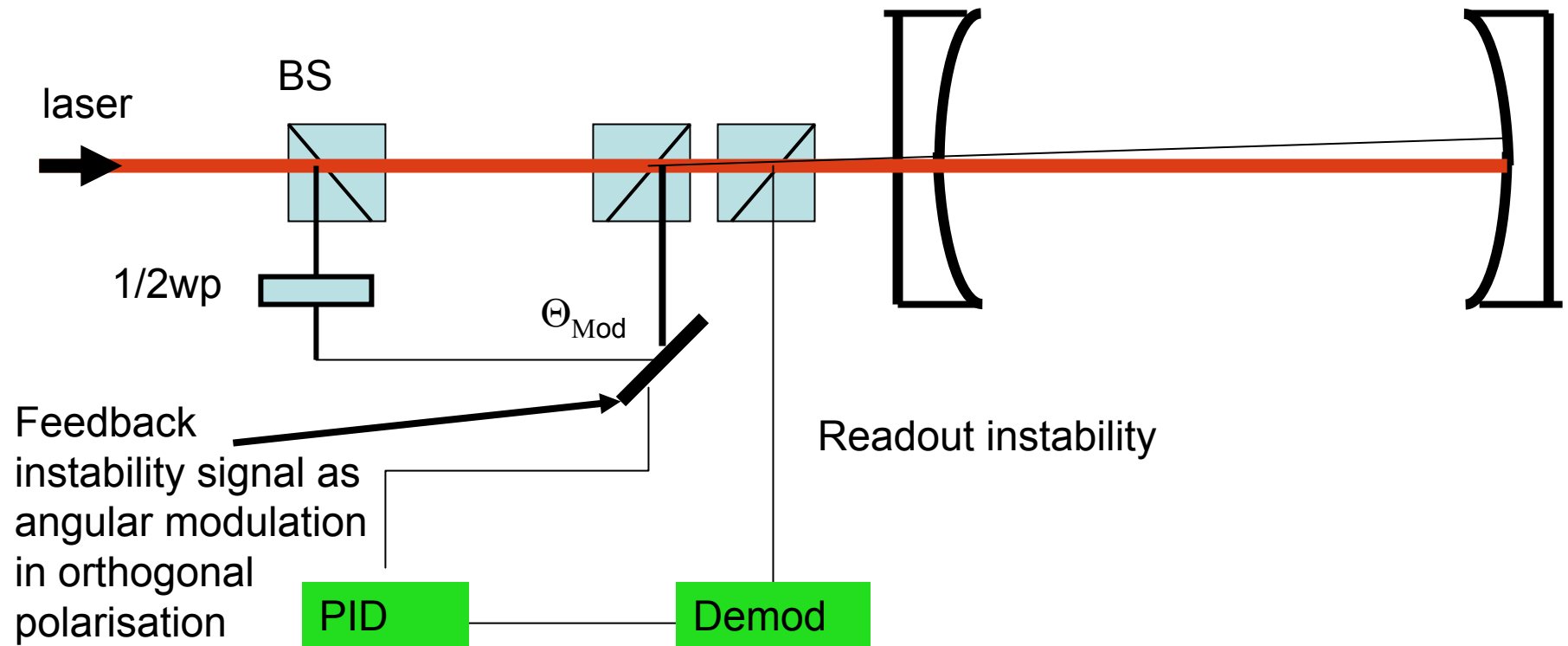

Instability Control by Parametric Cold damping

- Tranquilliser Cavity : small short cavity against test mass. BW \sim 1MHz, offset locked to enhance up-conversion=cold damping
- Now being tested at UWA
- Adds complexity with additional internal optical components, stabilised lasers etc

Instability Control by Direct Radiation Pressure Actuation

- Demonstrated non-resonant radiation pressure actuation at UWA (walk off delay line)
- Adds internal complexity
- Possible shot noise and intensity noise problems

Instability control by local control feedback

- Needs direct actuation on test mass
- Capacitive actuation being tested at Gingin

Gingin Prediction

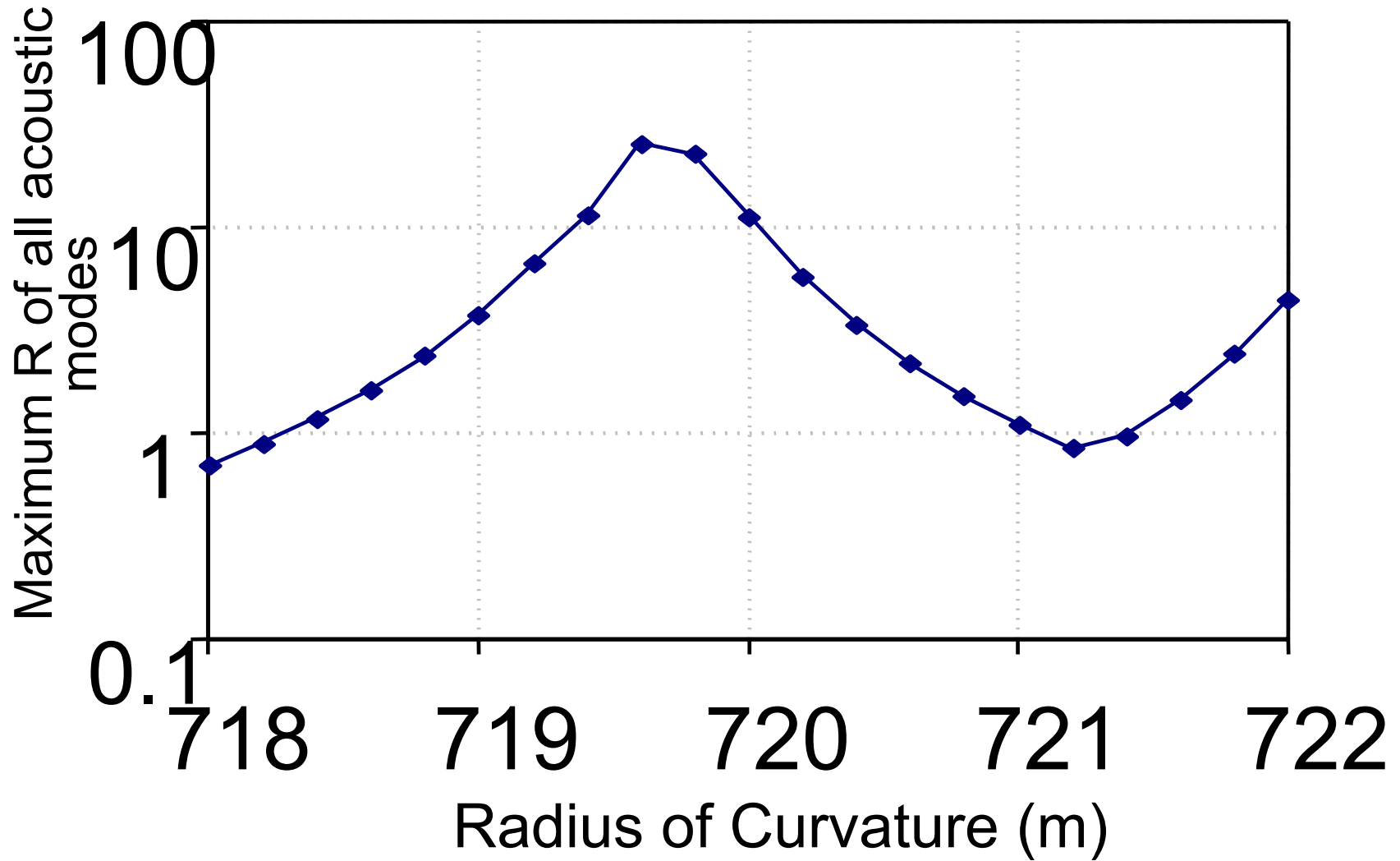

Conclusion

- Braginsky was right...parametric instabilities are inevitable.
- Thermal tuning can minimise instabilities but may be too slow in fused silica.
- Sapphire ETM gives fast control and reduces total unstable modes from ~28 to 14 (average),
- Can be actively controlled by various schemes
- Reinjection Damping allows damping without adding internal complexity.
- Gingin HOPF is an ideal test bed for these schemes.

$$R = 2076.5 \text{ m}$$

$$g_{\text{mirrors}} = -0.926$$

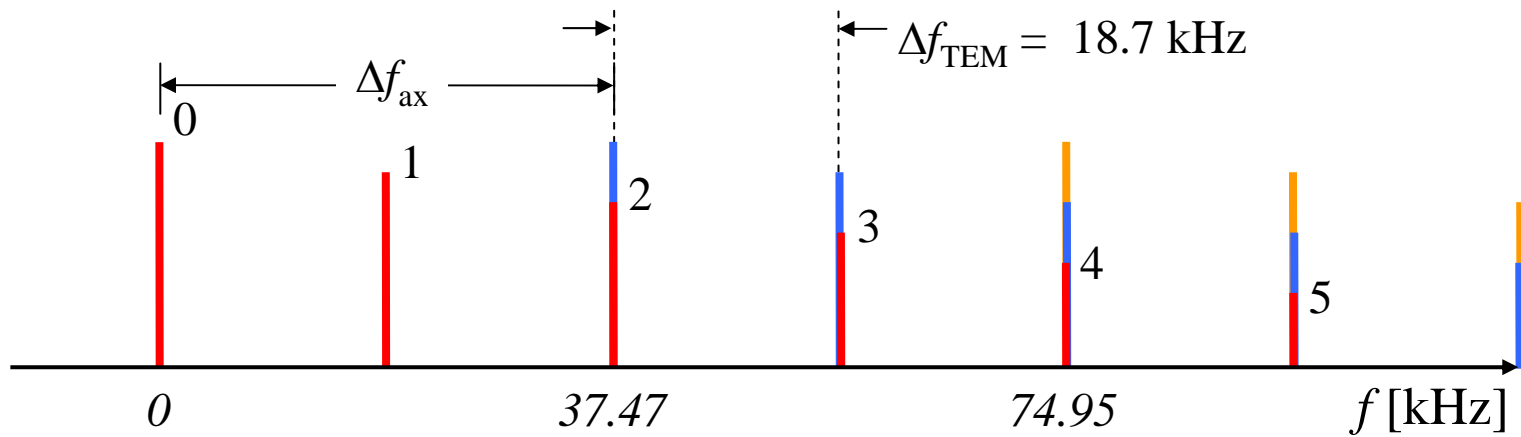

Con-focal !

$$R = 54416 \text{ m}$$

$$g_{\text{mirrors}} = 0.926$$

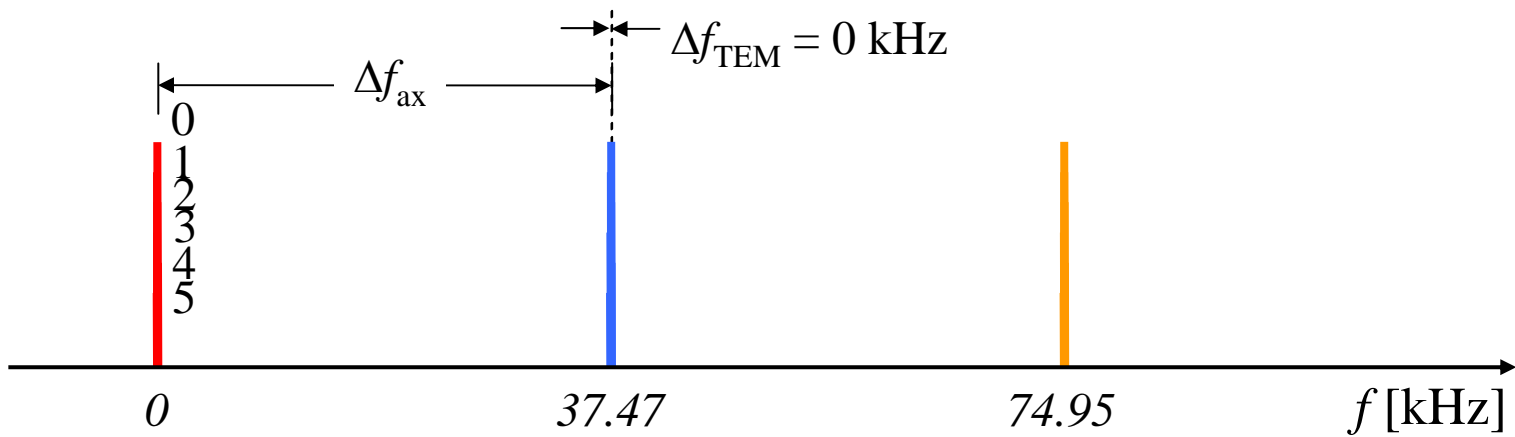

Near Planar !

$$R = 4000 \text{ m}$$

$$g_{\text{mirrors}} = 0$$

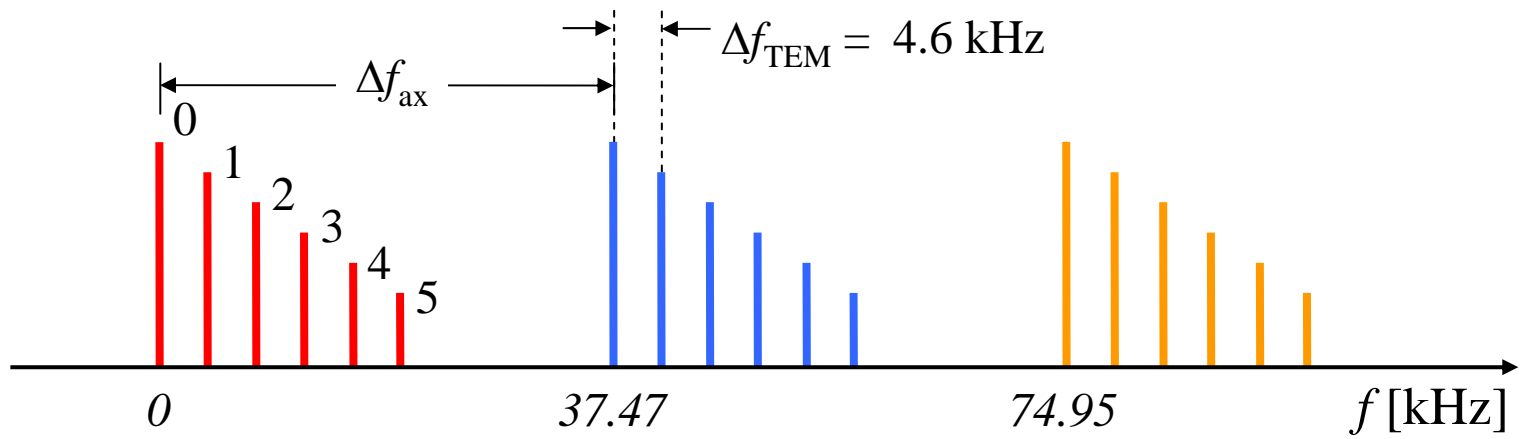

$$R = 2000 \text{ m}$$

$$g_{\text{mirrors}} = -1$$

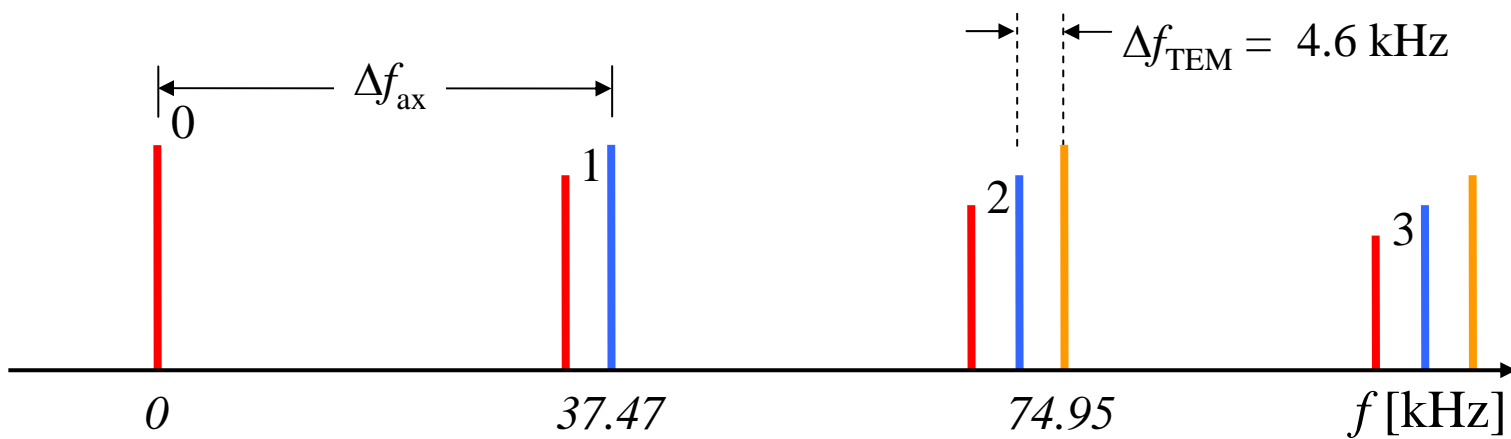

- ETM heated by the non reflective side (side outside the arm cavity)
- Steady state deformations only depend on the heating power not on the heat pattern
- However the test mass deformations evolution depends on the heat pattern
- In the previous example, after 1 minute we reach the steady state value for sapphire against ~ 25 minutes for fused silica
- An optimal time dependent heating power must exist to reach steady state quickly (faster for sapphire)



An Experiment to Investigate Parametric Instabilities in High Power Cavities



C. Zhao, L. Ju, S. Gras, J. Degallaix, and D. G. Blair
School of Physics, The University of Western Australia

Introduction:

- Advanced laser interferometric gravitational wave detectors require very high laser power (~ 1 MW) to approach (or beat) the standard quantum limit as well as high mechanical Q-factor test masses to reduce the thermal noise.
- Parametric instability is inevitable in advanced interferometric GW detectors which will make them inoperable.
- We have predicted that parametric instabilities can be controlled by thermal tuning.
- Australian Consortium for Interferometric Gravitational Astronomy (ACIGA) high optical power research interferometer will enable observation of this phenomena and the implementation of the control scheme.

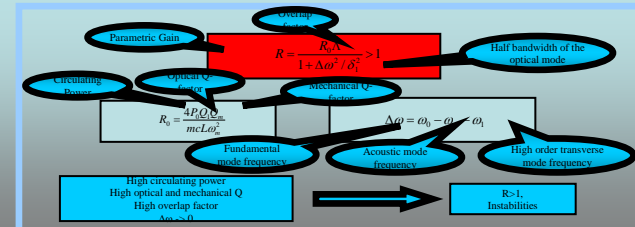
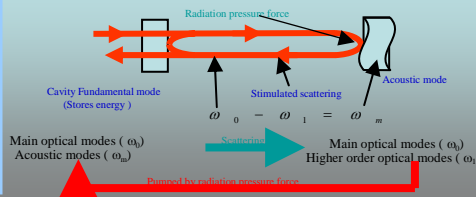
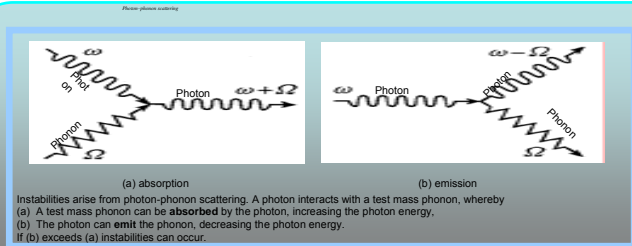

Nominal Parameters of ACIGA Interferometer

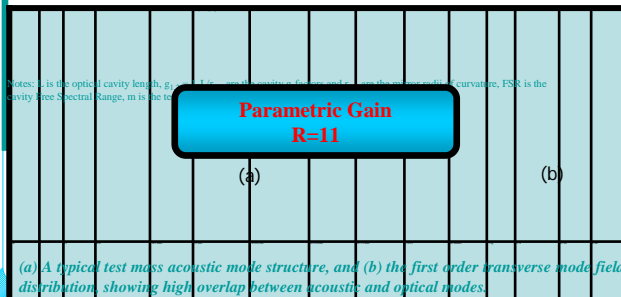

Control the parametric instability

With other parameters constant, increasing $|\Delta\omega|$ will reduce parametric gain, R.

Equation: $Mode \text{ Spacing} = FSR \times \text{ArcCos}(\sqrt{g_1 g_2})$

Thermally tuning the radii of curvature, r_1 and/or r_2 , then g_1 and/or g_2 , will change the optical mode spacing and the high order transverse mode frequency, ω_1 . In consequences, $|\Delta\omega|$ is increased.

It is possible to reduce R to less than unity and eliminate the parametric instability completely

Thermal Tuning of the Radius of curvature

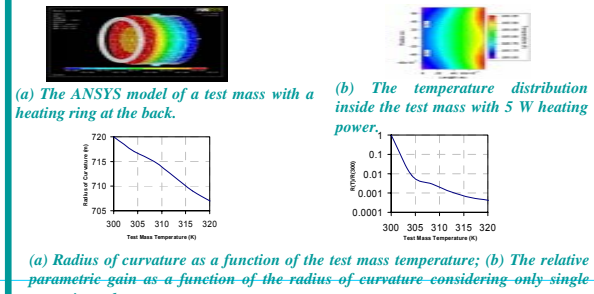

Tuning the mirror radius of curvature

The maximum parametric gain as a function of the radius of curvature, (a) Gingin cavity, (b) Advanced LIGO with sapphire test masses, and (c) fused silica test masses.

It can be seen that with sapphire test masses in the Gingin cavity and Advanced LIGO the parametric instability can be eliminated. In the case of fused silica test masses in Advanced LIGO the parametric gain can be minimised but not eliminated.

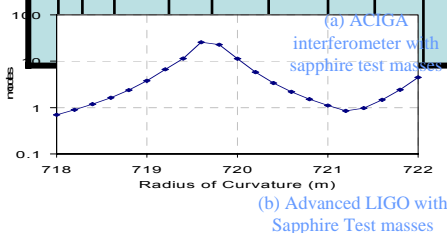

Conclusions:

- The parametric instability will appear in ACIGA's high optical power research interferometer at Gingin, WA.
- By thermally tuning the radius of curvature the parametric instability can be completely eliminated at ACIGA interferometer as does Advanced LIGO with sapphire test masses.
- The extra components for the control is simply a heating ring at back of the end test mass.
- The control scheme with thermal tuning tested on ACIGA interferometer at Gingin can be extended to Advanced GW detectors, such as Advanced LIGO.

* Braginsky, et al, Phys. Lett. A, 305 111 (2002)



g-factor variation with radius of curvature, L = 4 km

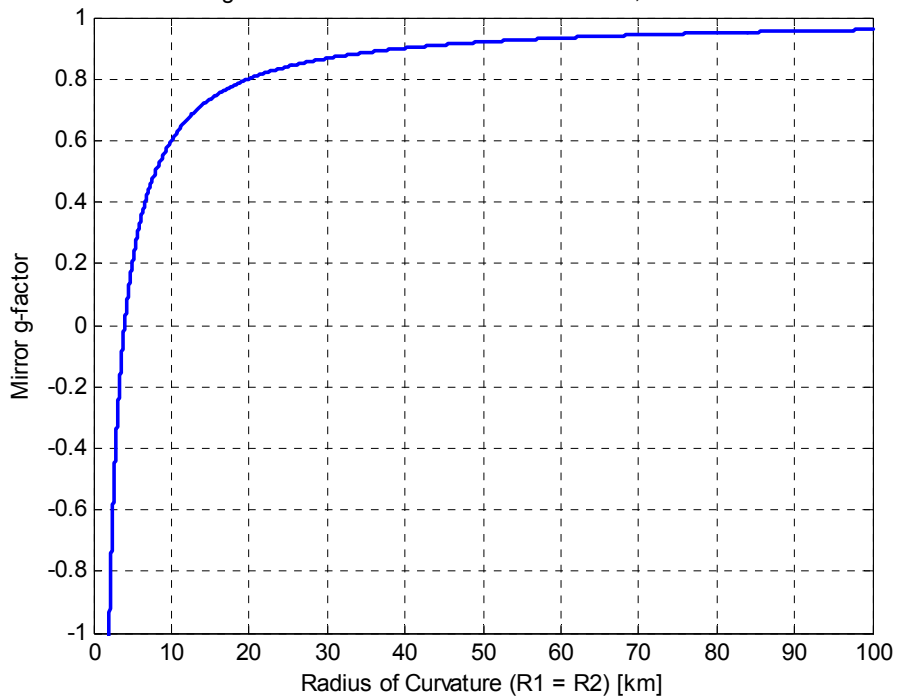

Cavity g-factor variation with ROC, L = 4 km

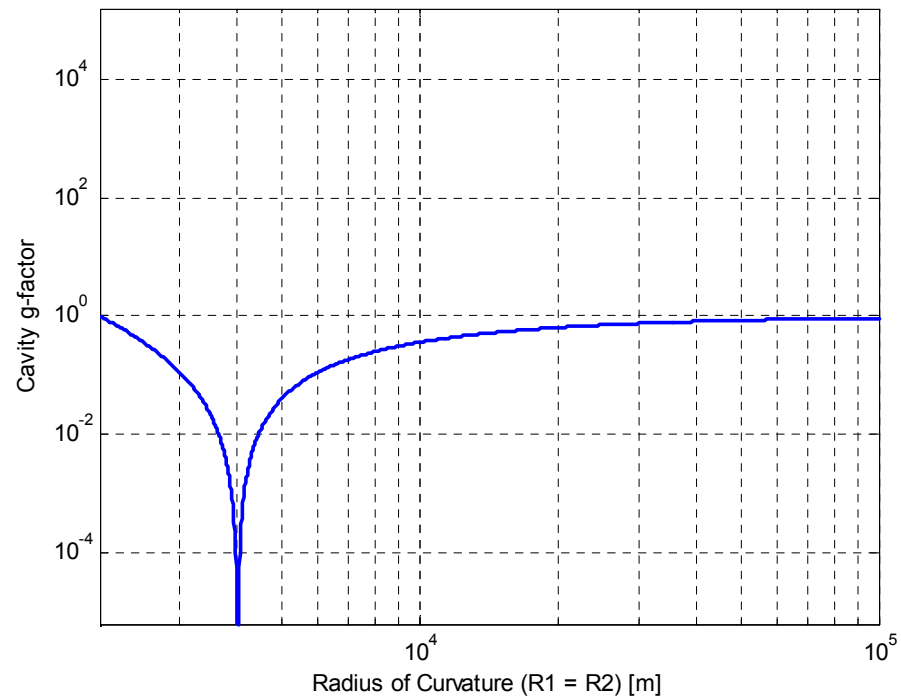

Gouy Phase vs ROC

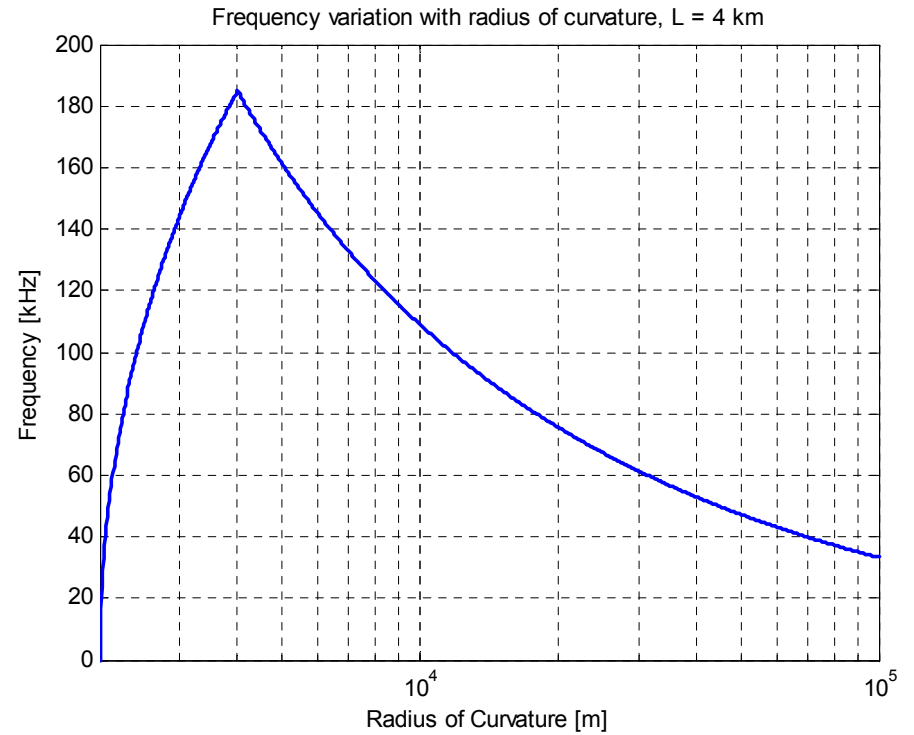
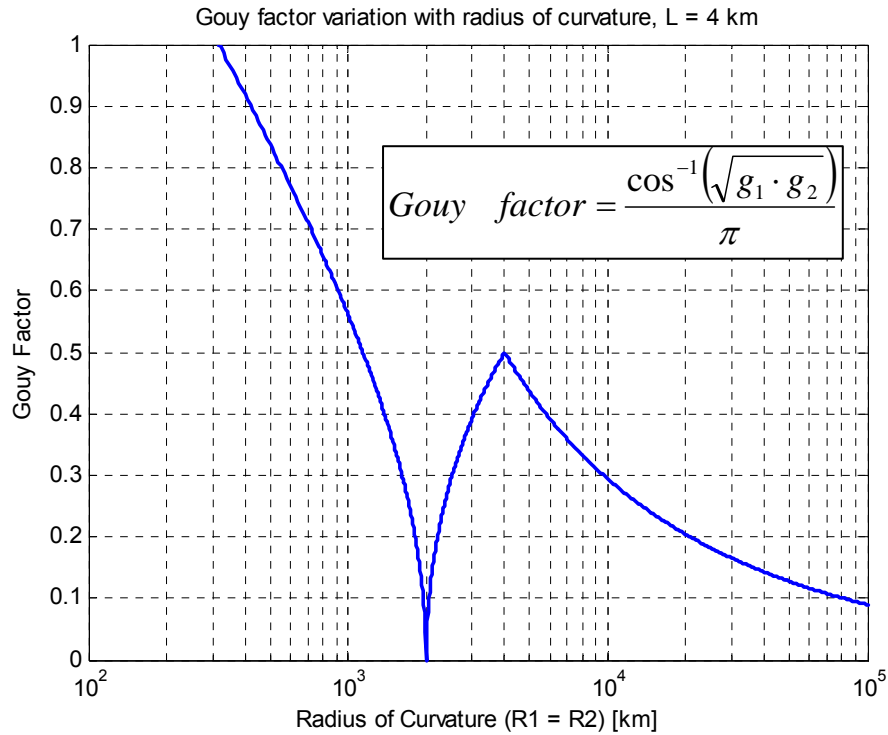

Gouy factor variation with radius of curvature, L = 4 km

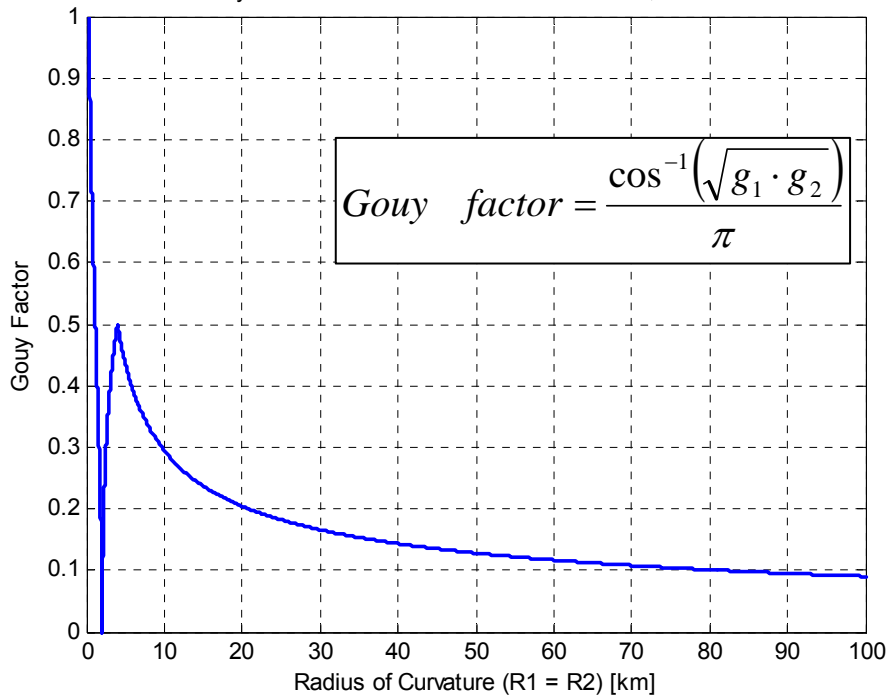

roc km, lin, log

Frequency variation with radius of curvature, L = 4 km

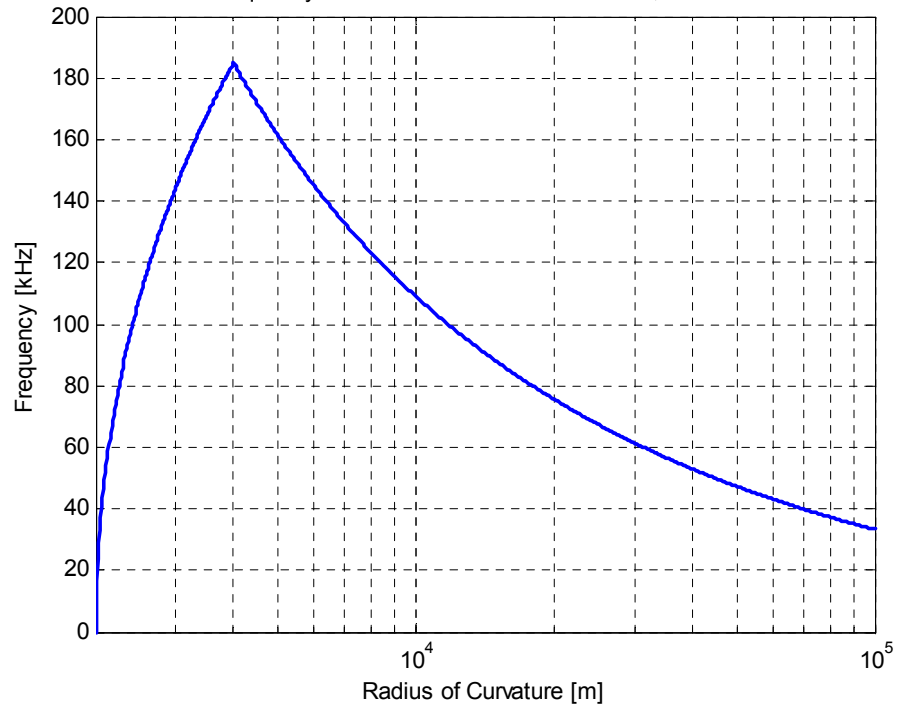

HOM Frequency Offsets Δf

Planar = Degenerate Optical Cavity: No available Stokes modes except FSR which is symmetric

$$R = \odot$$

$$g_{\text{mirrors}} = 1$$

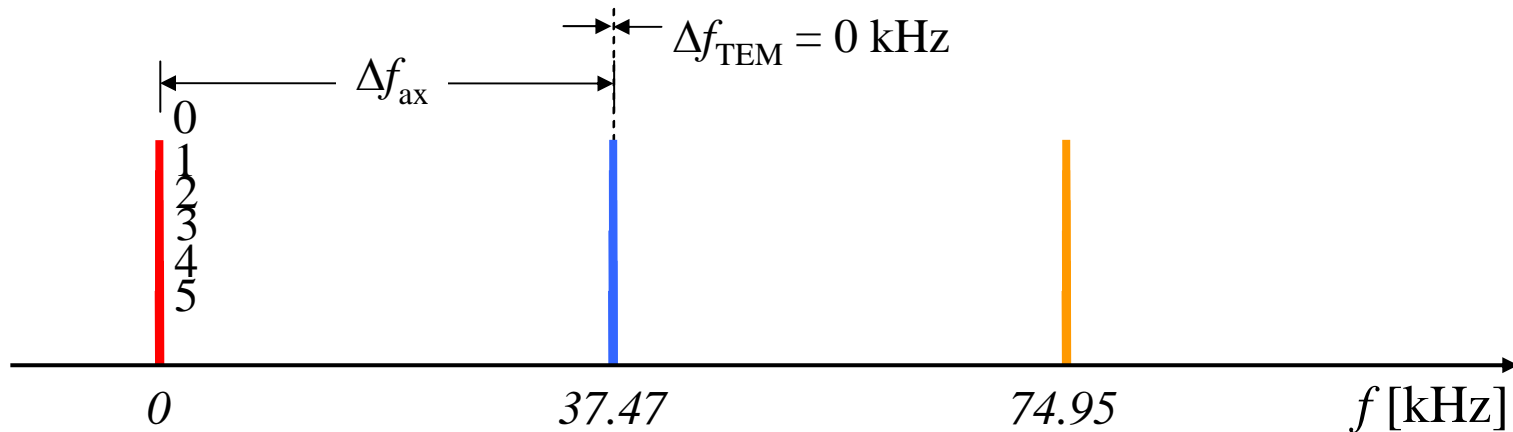

Confocal : $\Delta f = \text{half FSR}$

$$R = 4000 \text{ m}$$

$$g_{\text{mirrors}} = 0$$

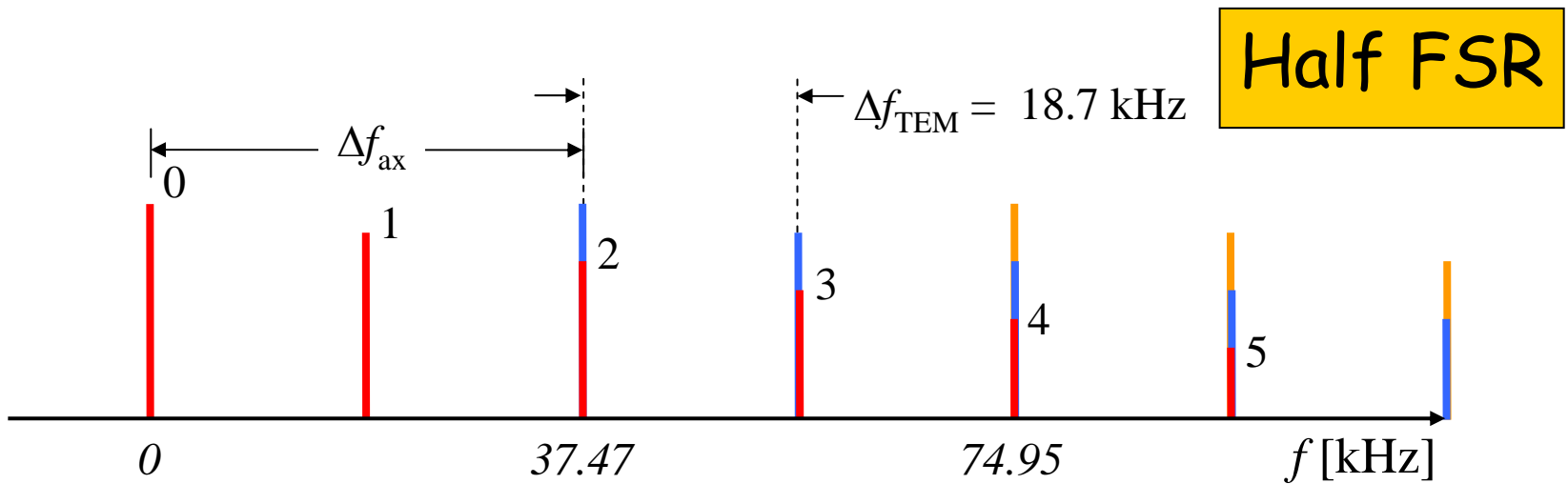

Concentric: HOM Degenerate

$\Delta f = 0$ or FSR : symmetric

$$R = 2000 \text{ m}$$

$$g_{\text{mirrors}} = -1$$

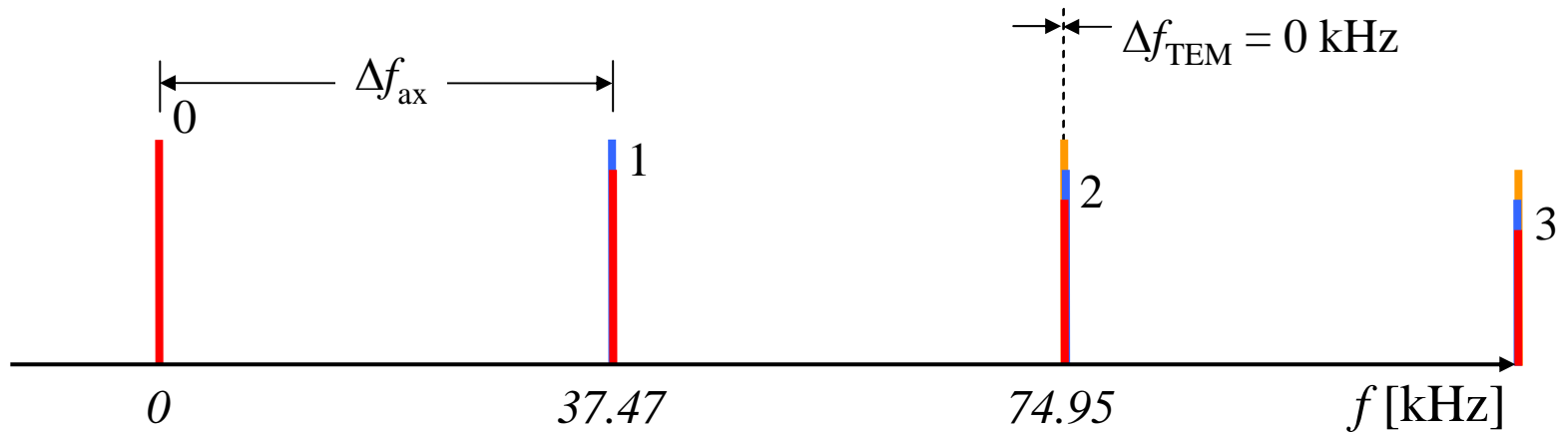

Mirror tuning evolution at fixed power

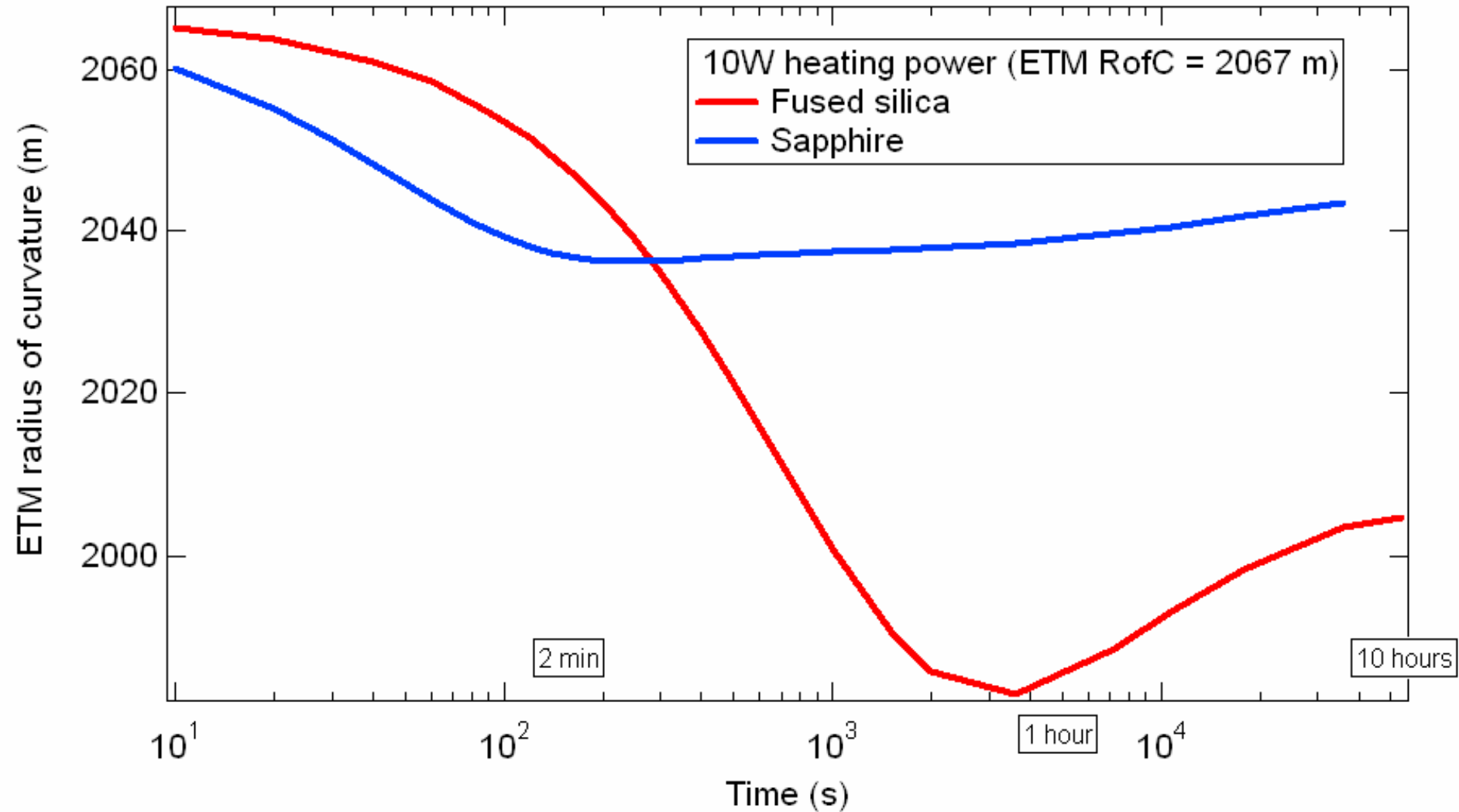

For appropriate spot size, typical Δf unavoidable

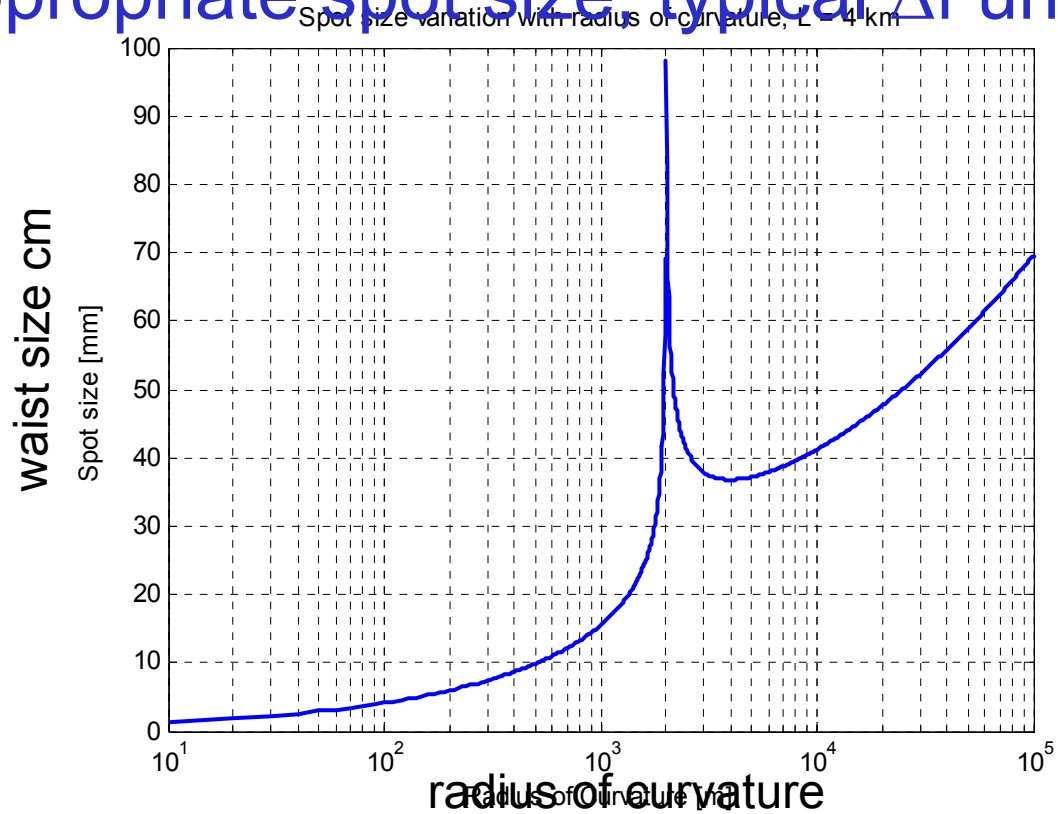

For a 6 cm spot size we have three solutions:

R (m)	g factor	Guoy factor	Waist radius (mm)	Δ Freq (kHz)
1981.9	1.036	1	N.A.	0
2076.5	0.858	0.877	11.51	4.6
54416	0.858	0.123	58.89	4.6