

HAM Overview - One Possible method of Assembly  
for the Advanced LIGO Mode Cleaner Controls  
Prototype Triple Pendulum Suspension

CALUM I. TORRIE  
California Institute of Technology  
LSC MEETING, HANNOVER  
AUGUST 2003

PHOTOS FROM CALTECH and from Stefan Gossler at GEO 600

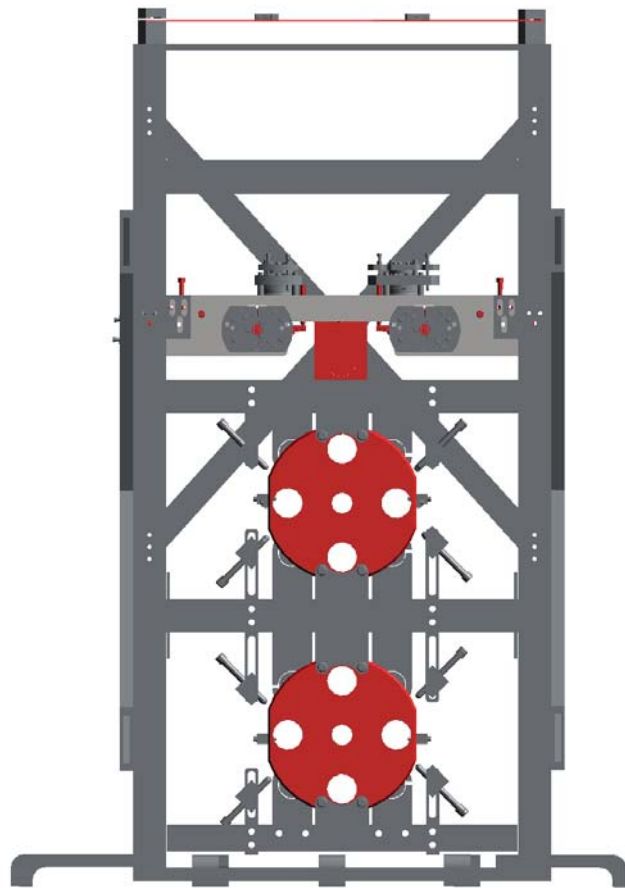

LIGO-G030386-03

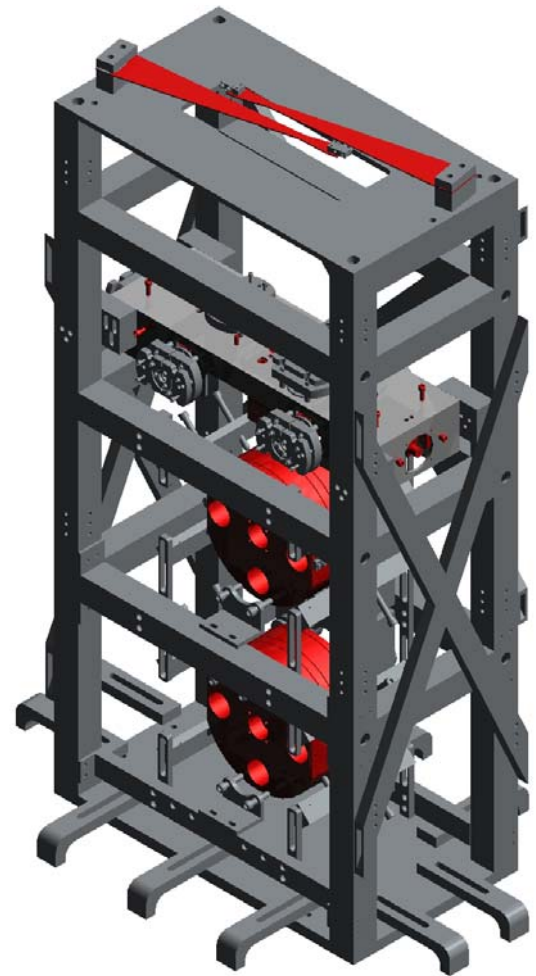

ALUKGLA0031aAUG03

2

**MODE CLEANER SUSPENSION**

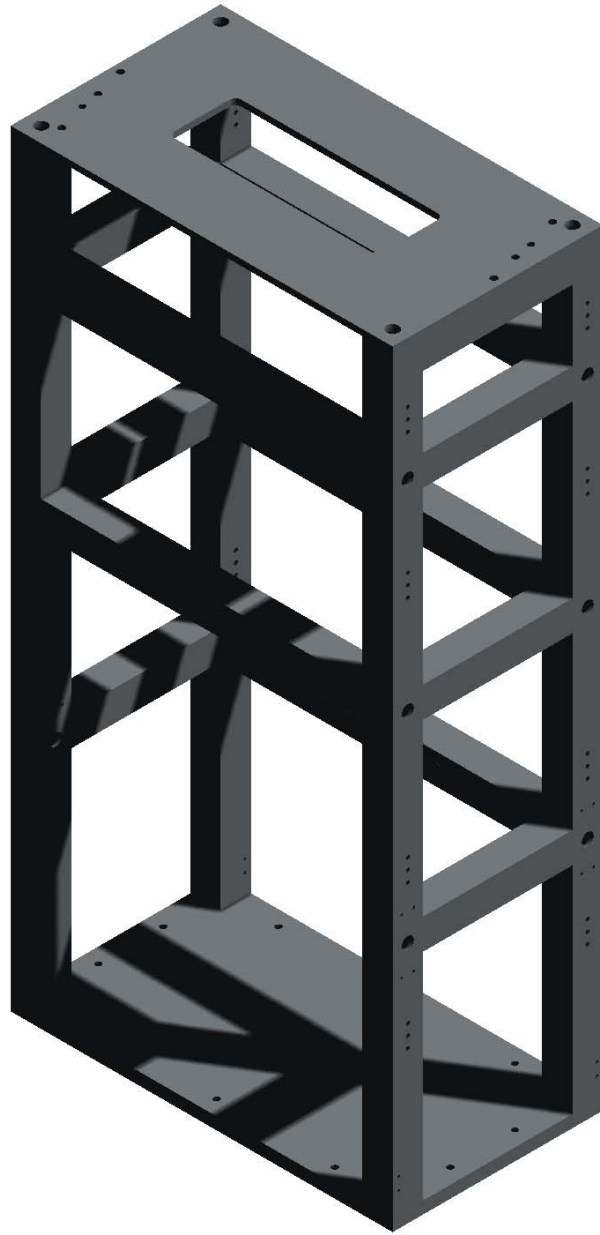

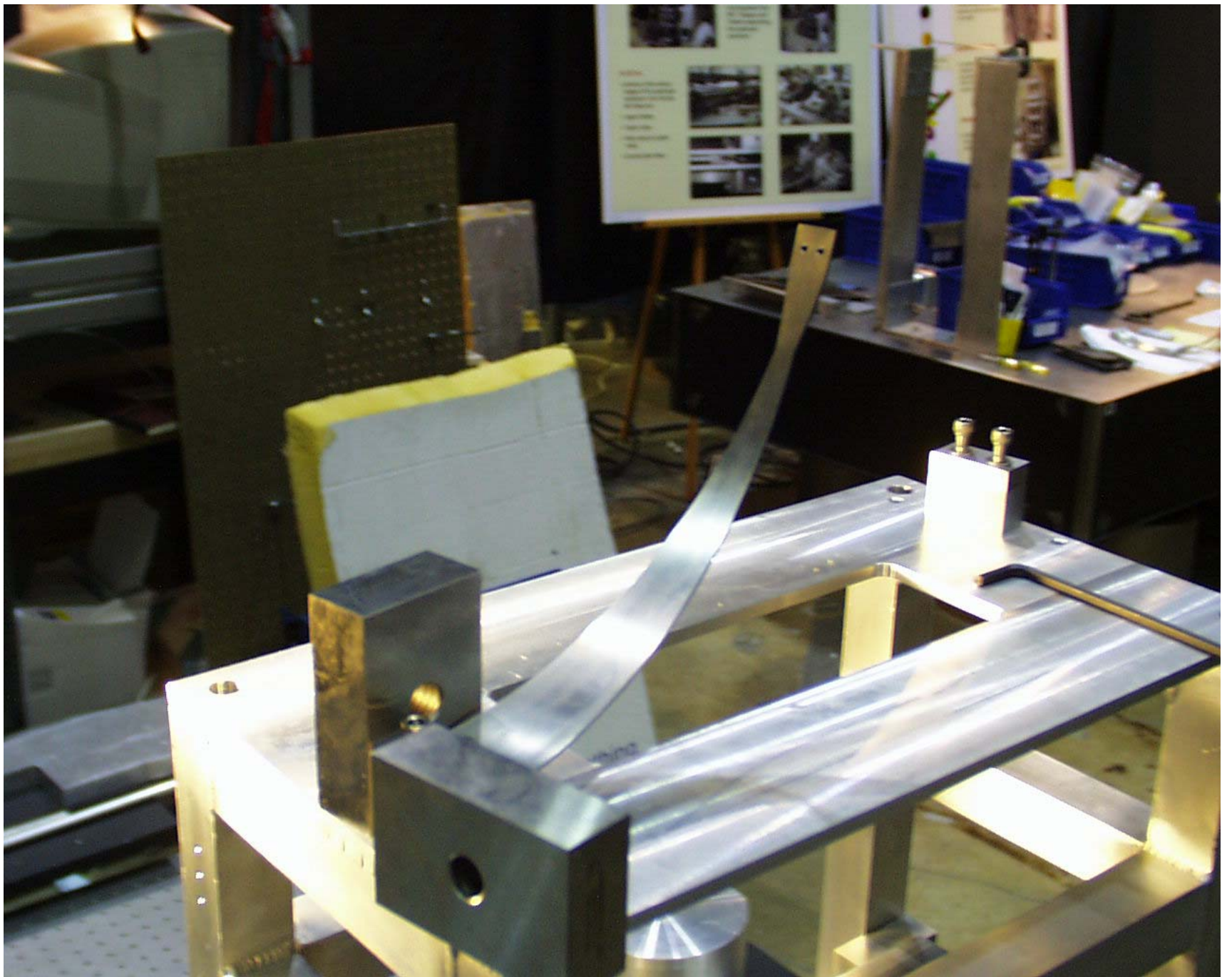



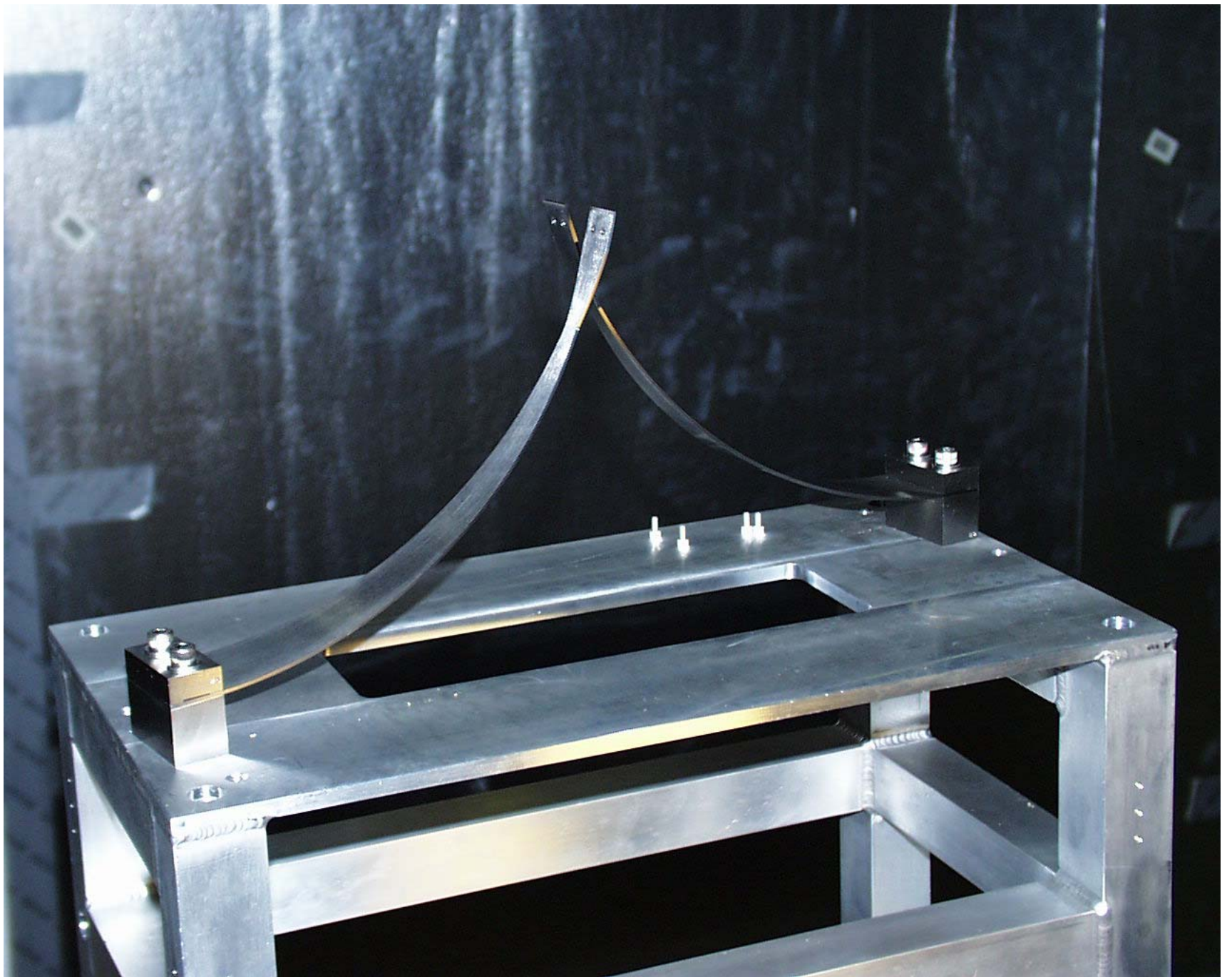

IGNORE TABLECLOTH

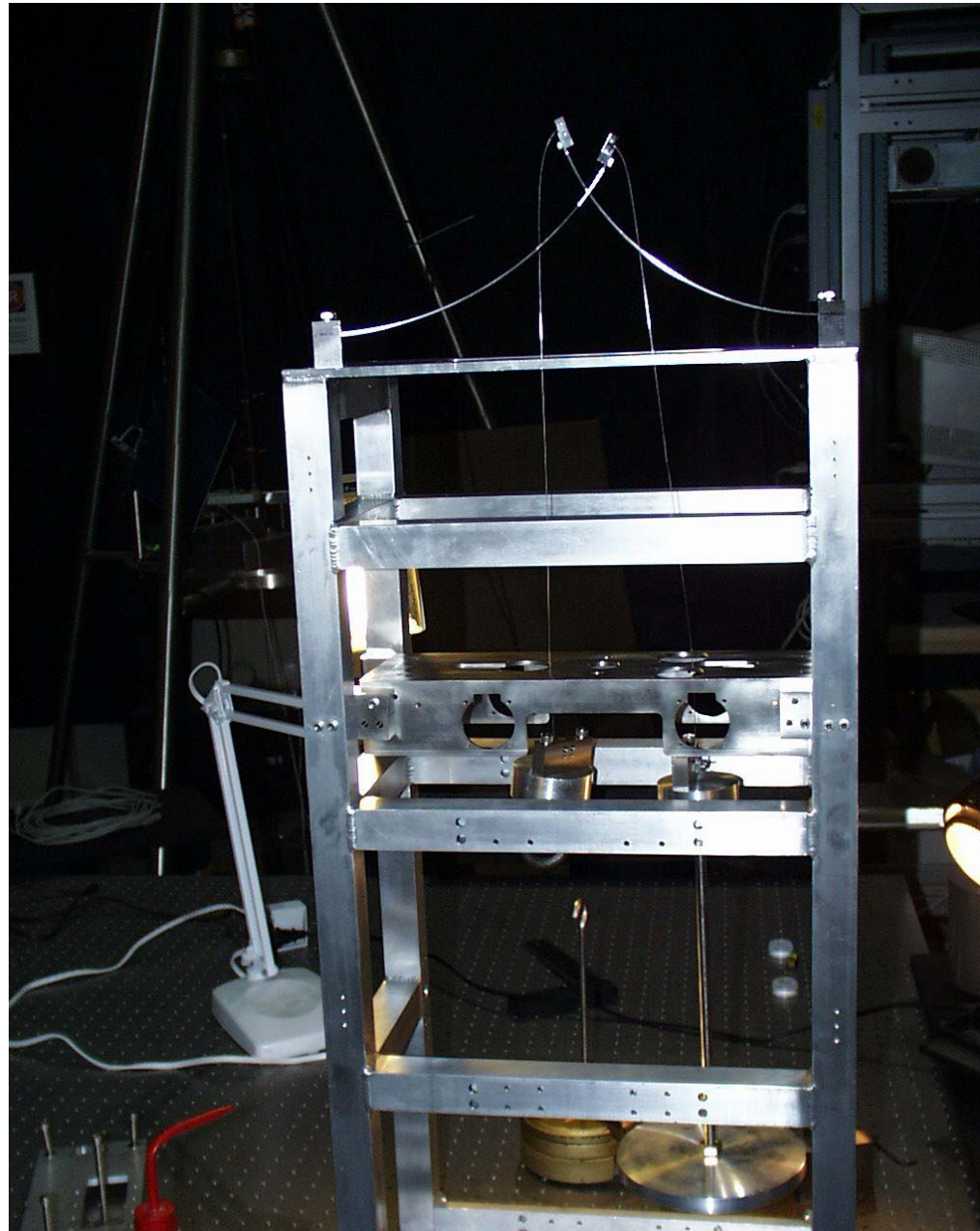

LIGO-G030386-03



IGNORE TABLECLOTH

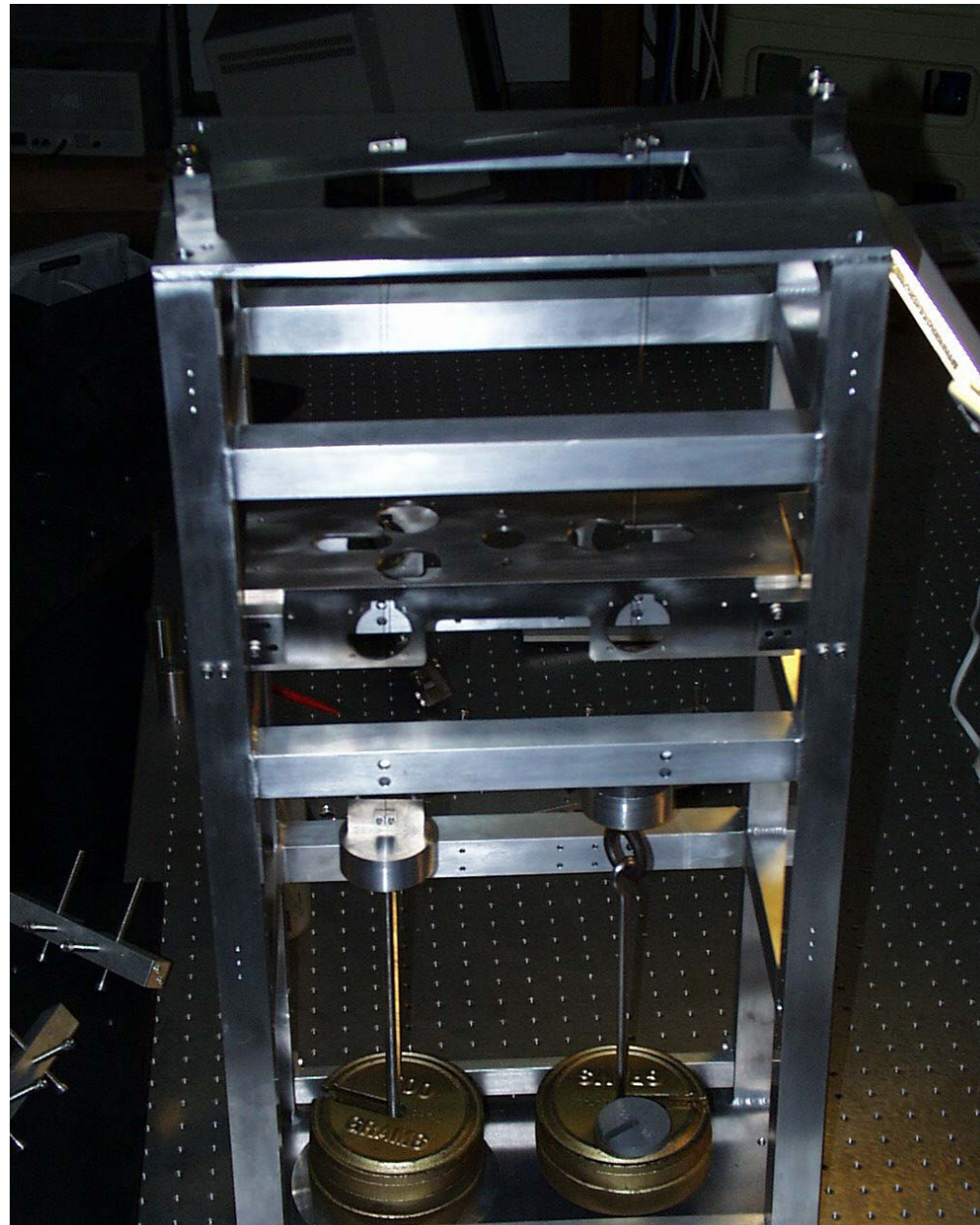

LIGO-G030386-03

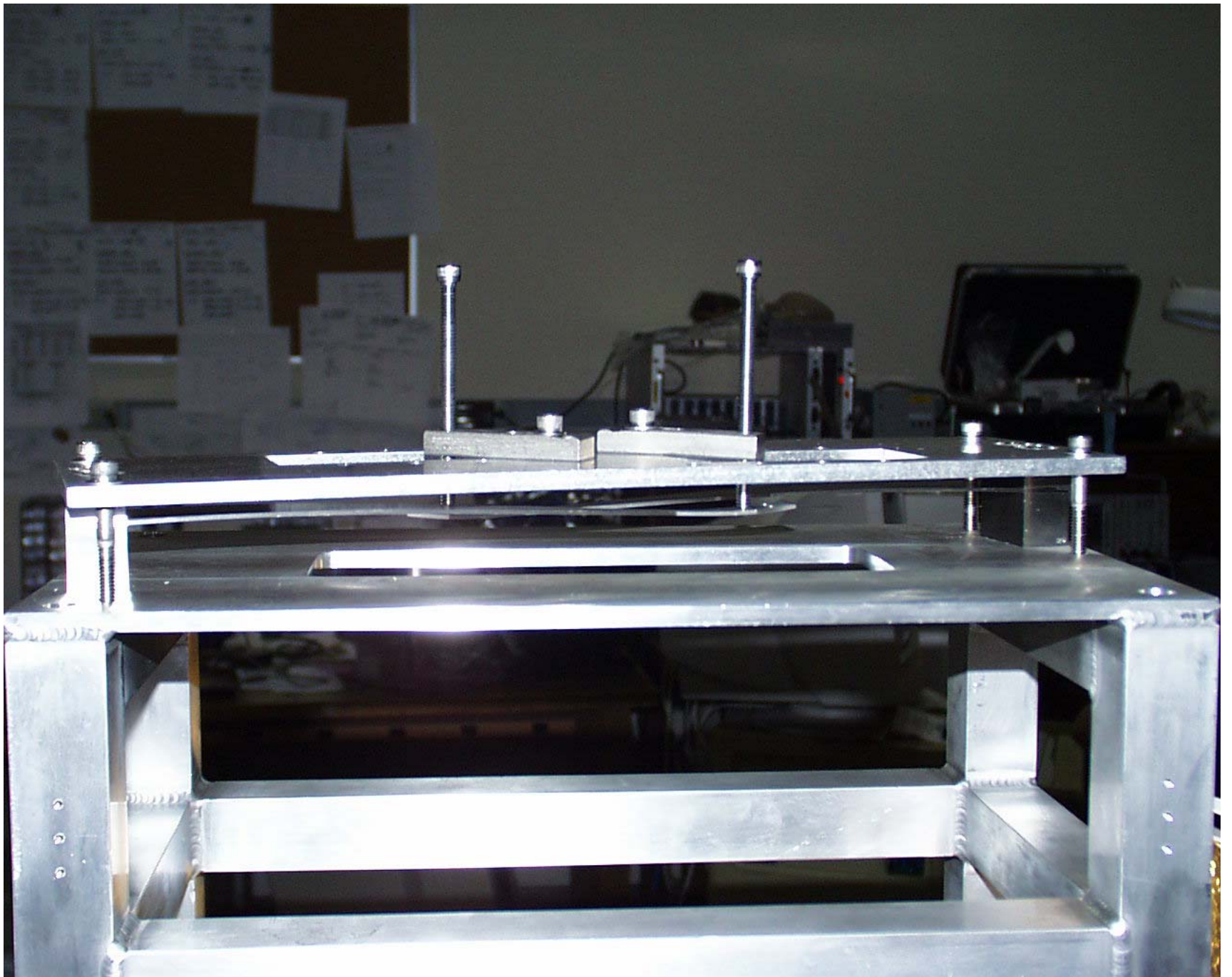



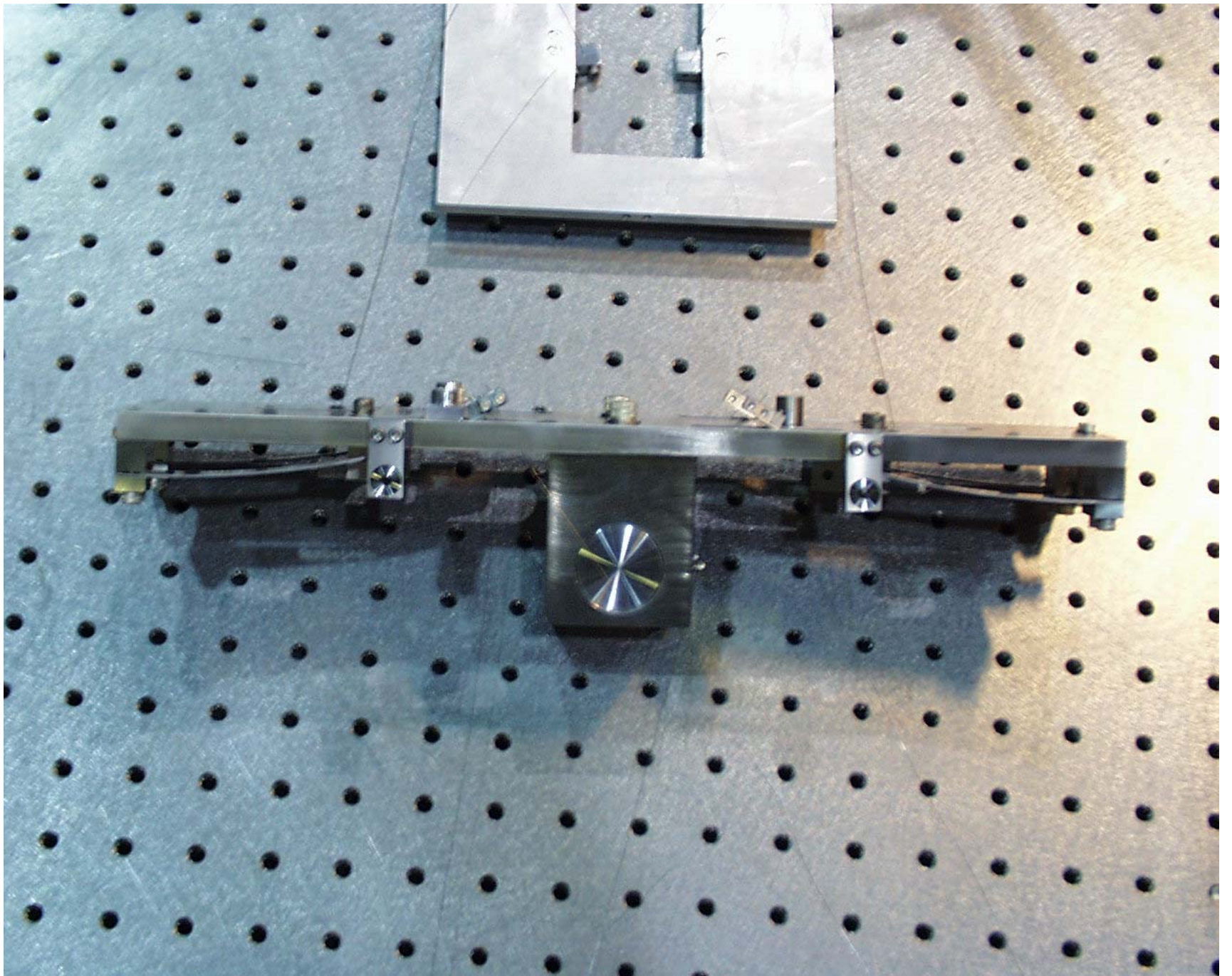



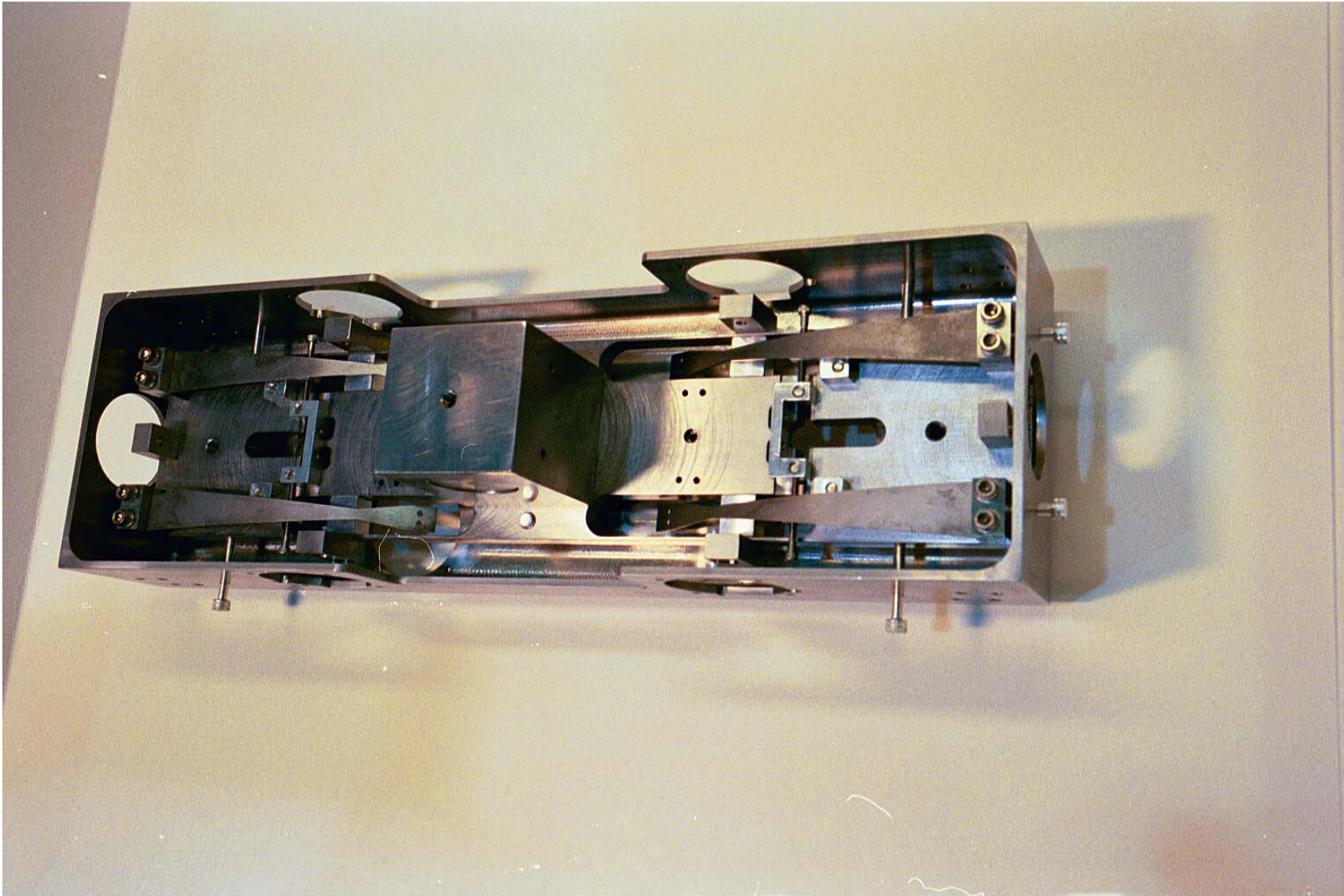

LIGO-G030386-03

ALUKGLA0031aAUG03

10

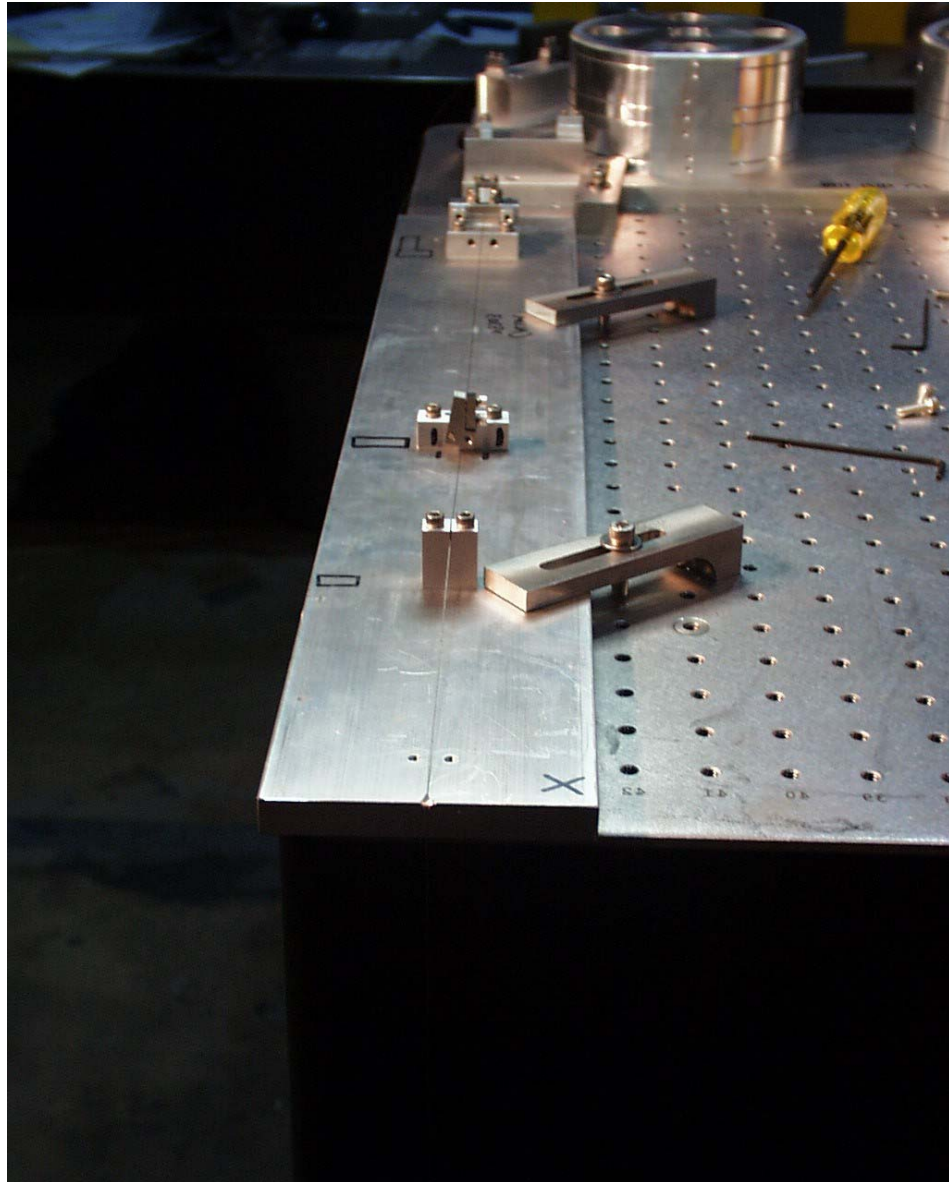



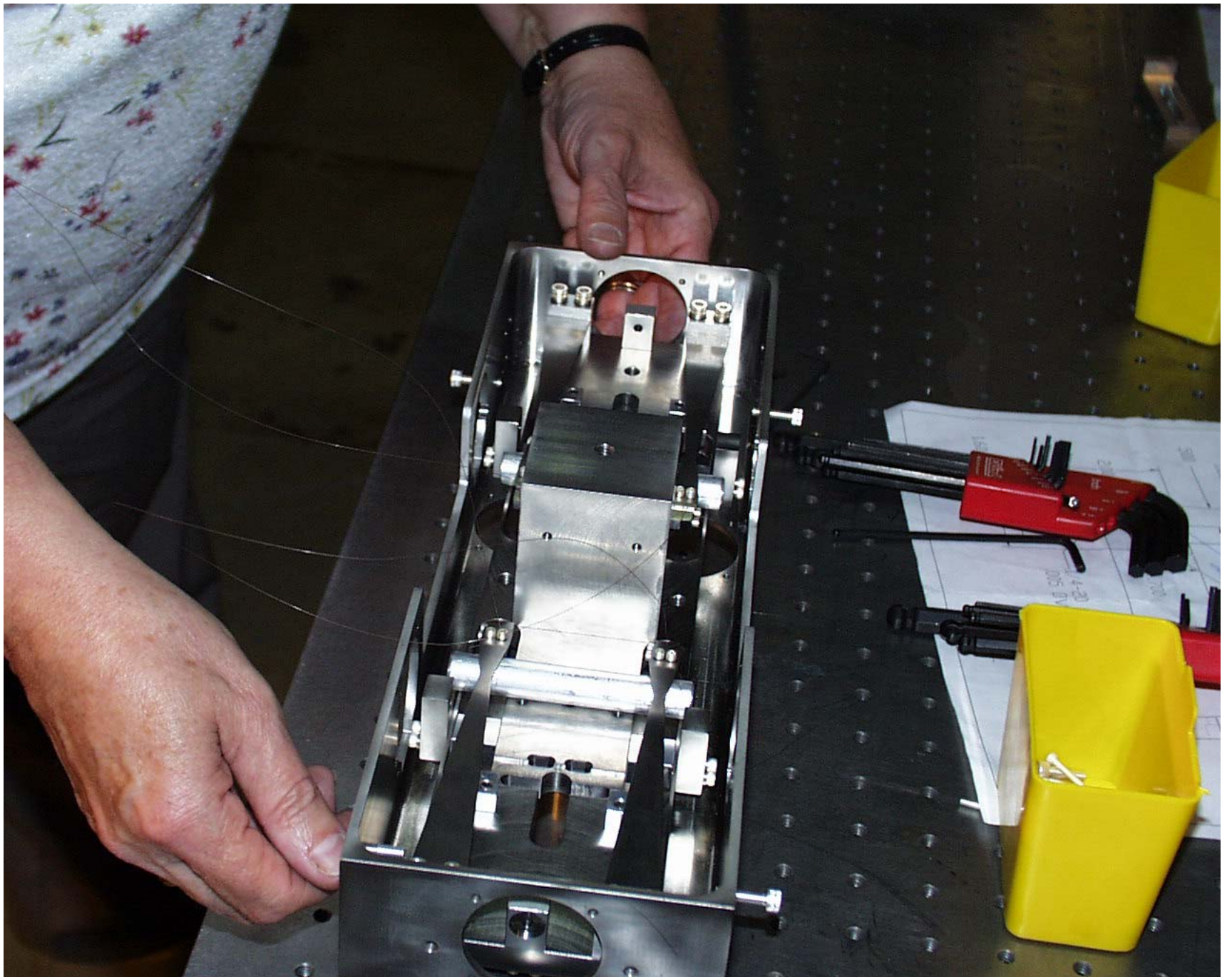



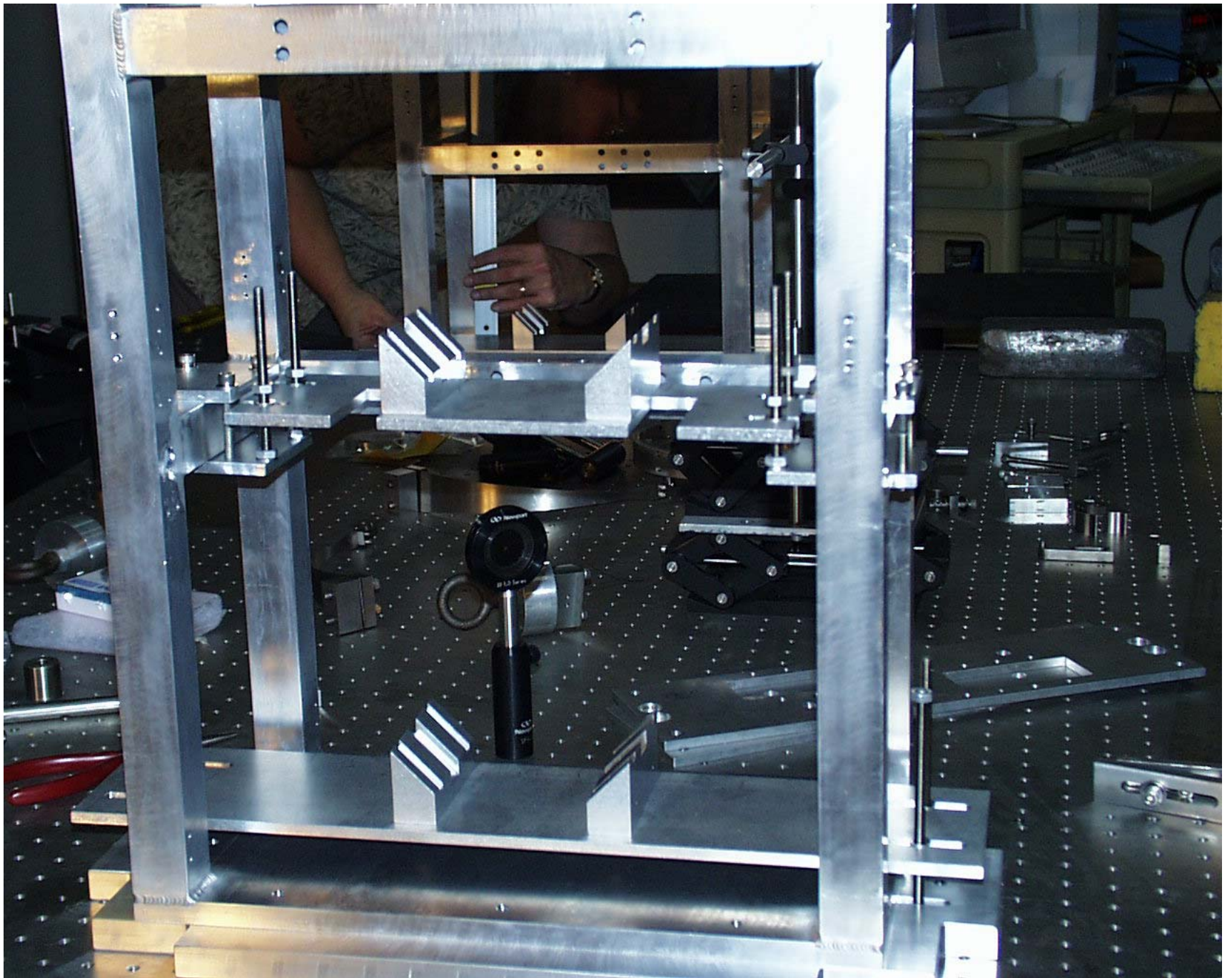



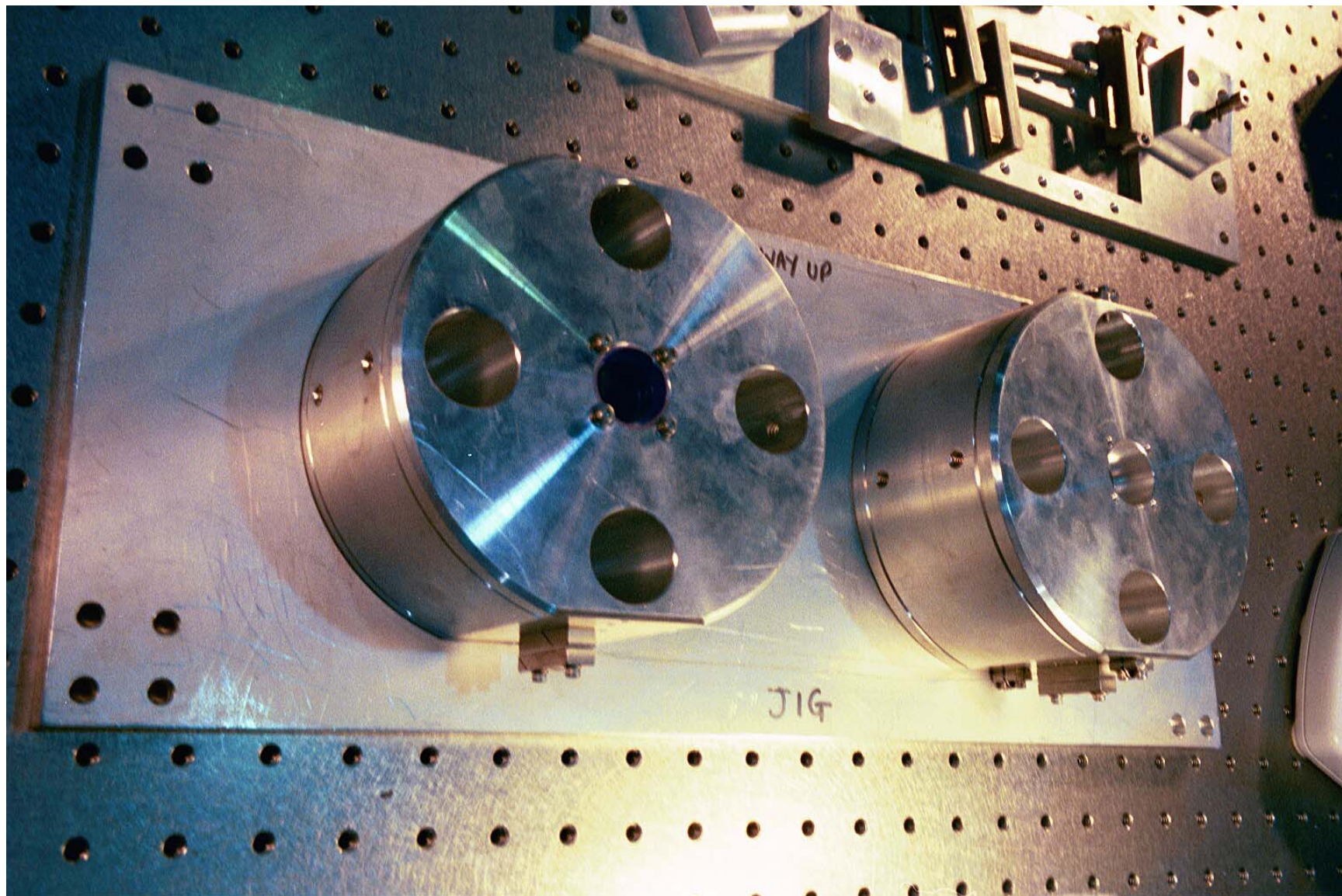

WAY UP

JIG



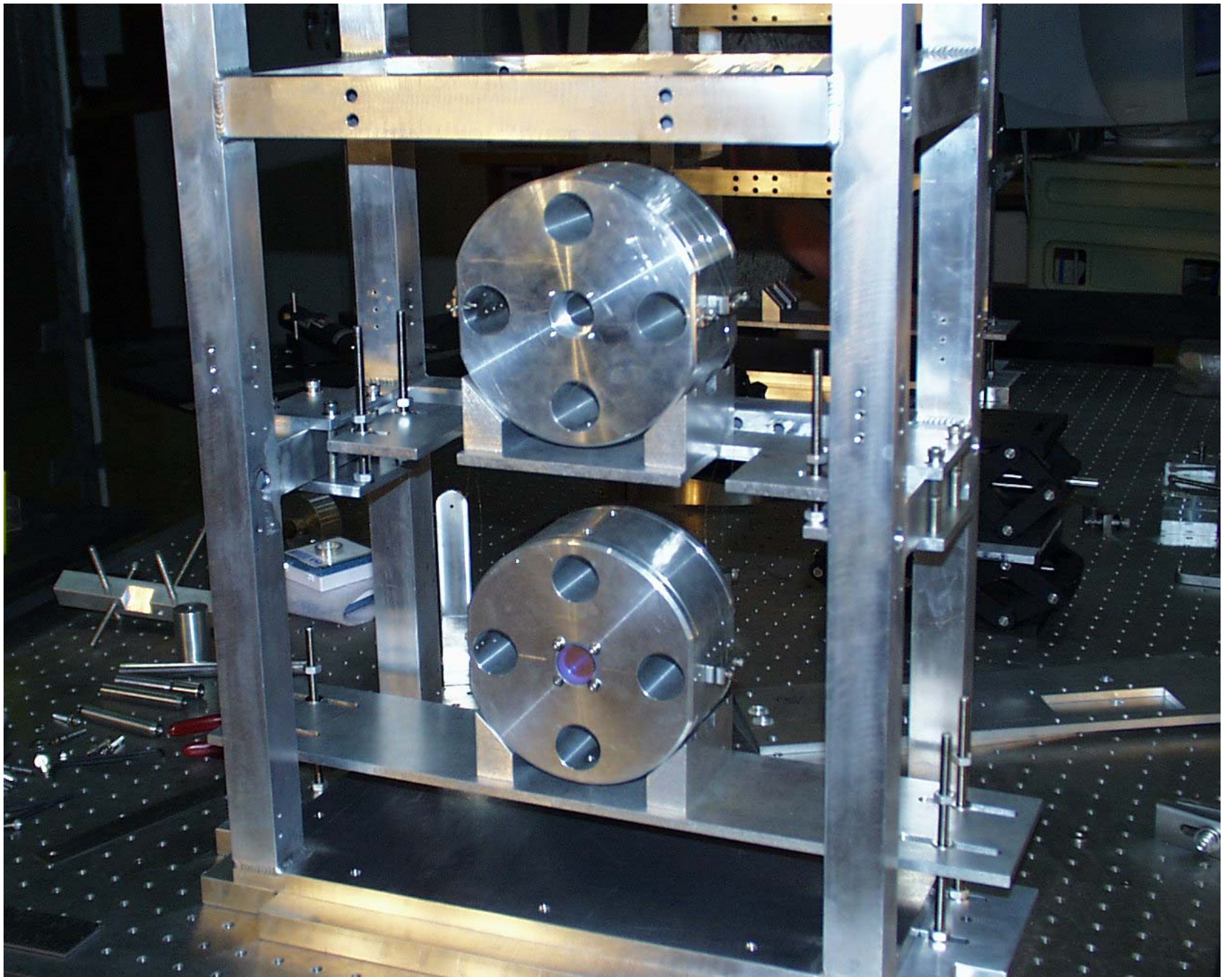



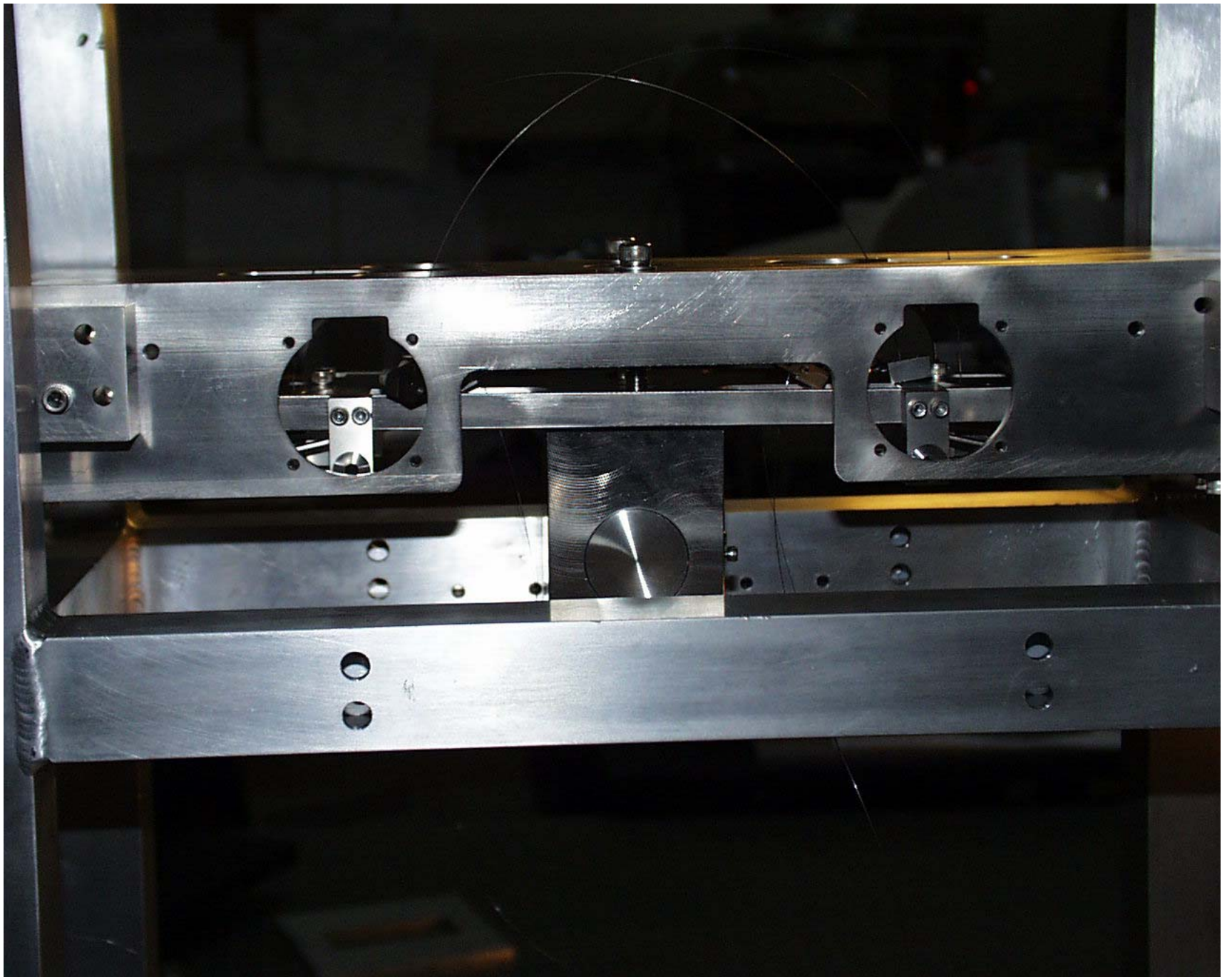



LIGO-G030386-03

ALUKGLA0031aAUG03

17



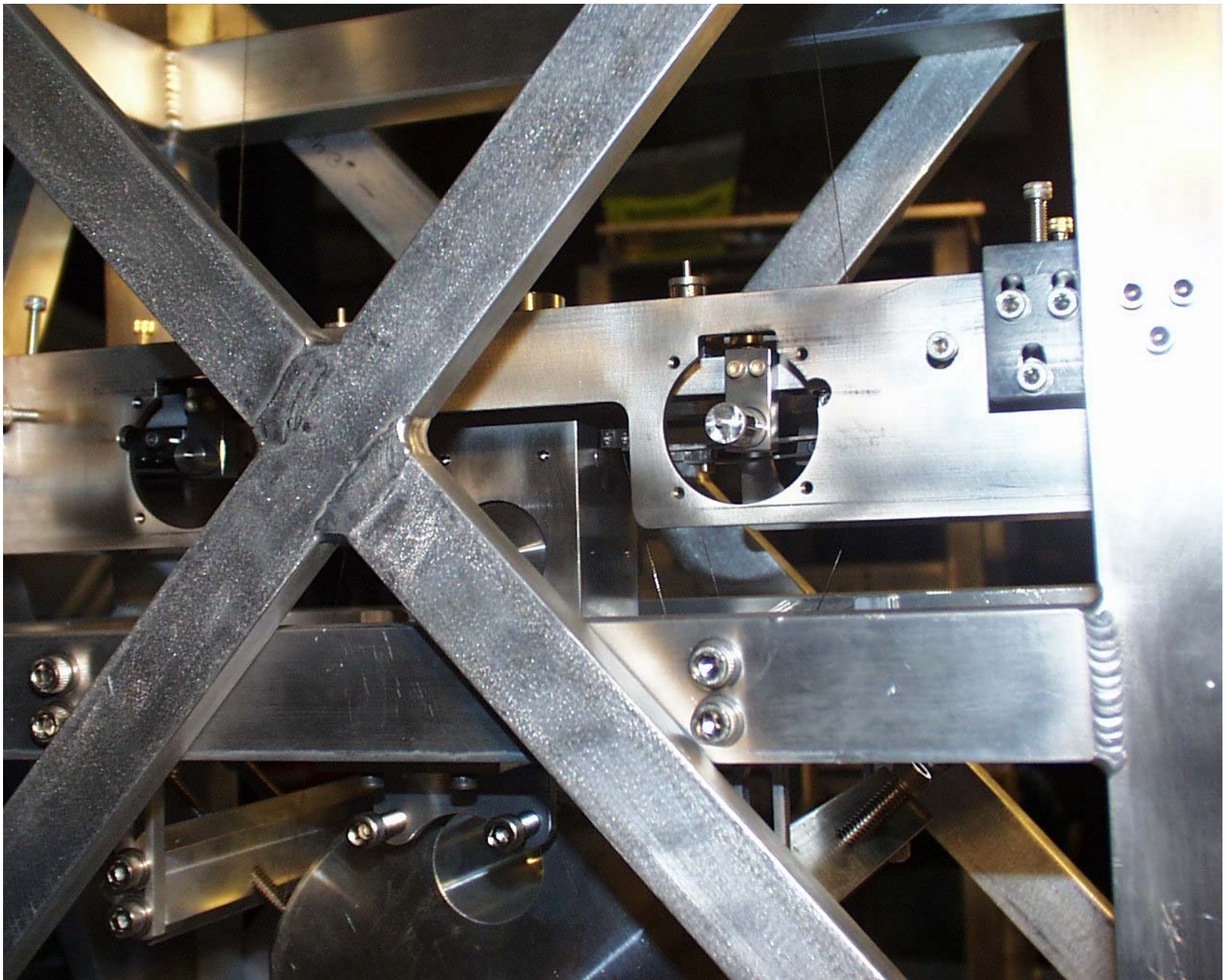

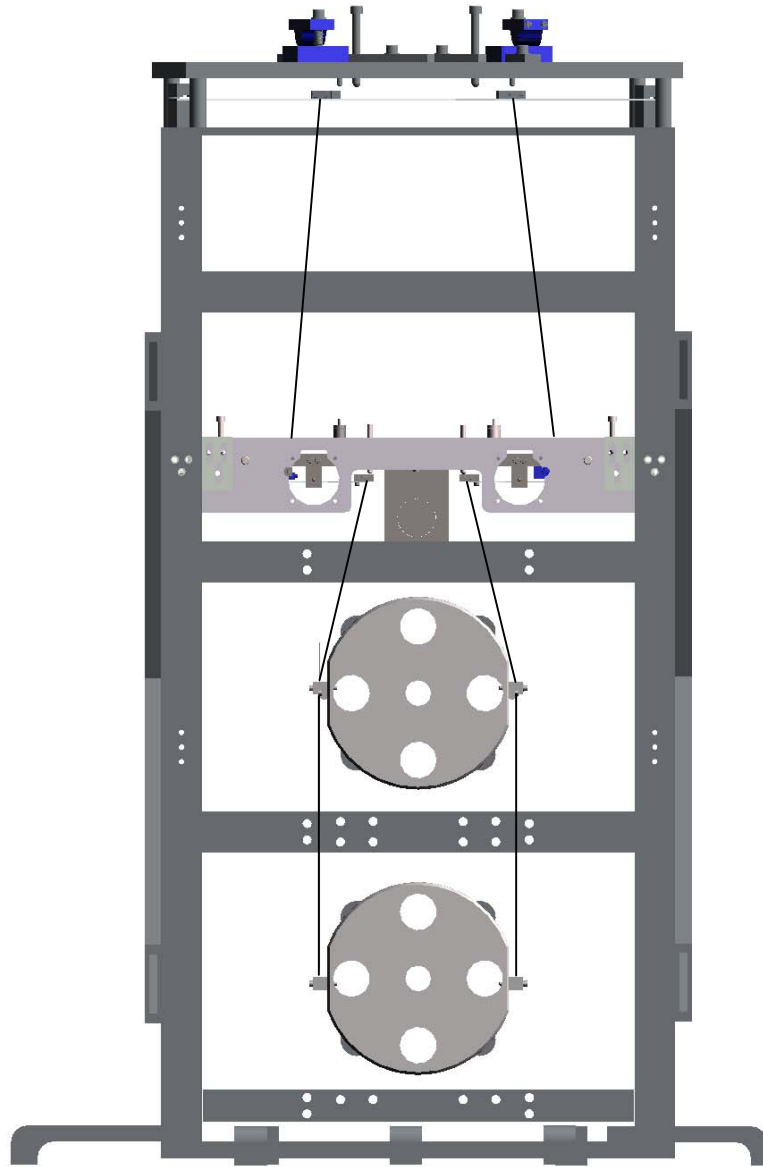



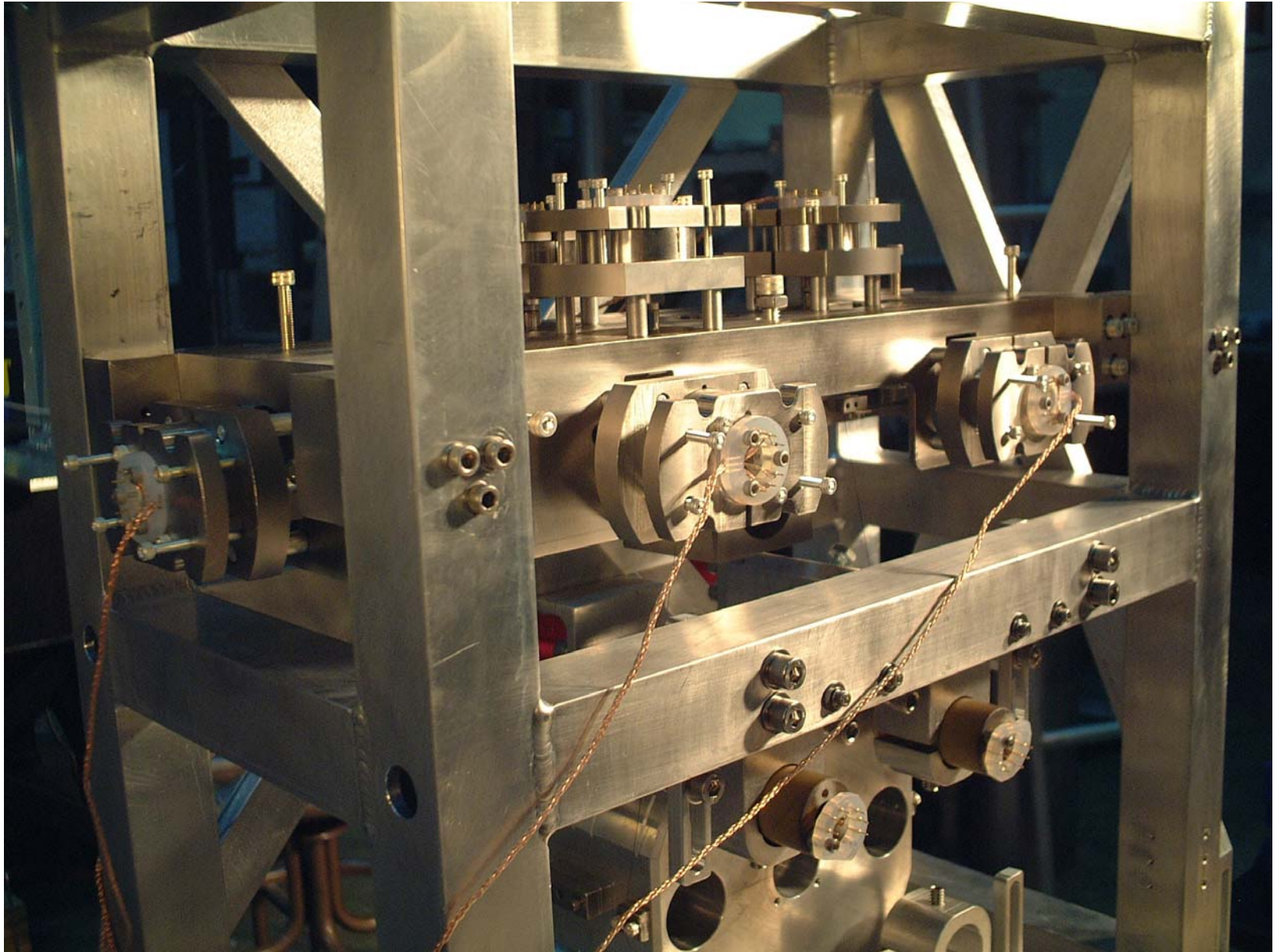

LIGO-G030386-03

ALUKGLA0031aAUG03

20





LIGO-G030386-03

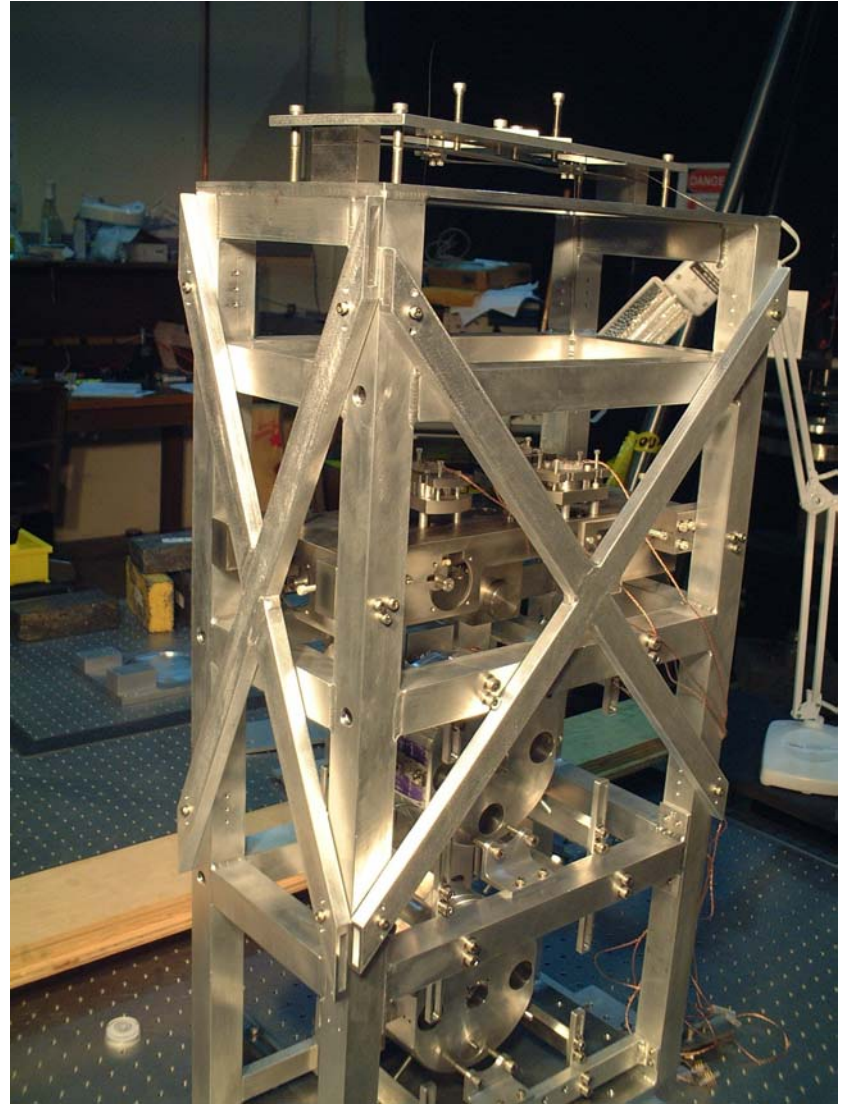

ALUKGLA0031aAUG03



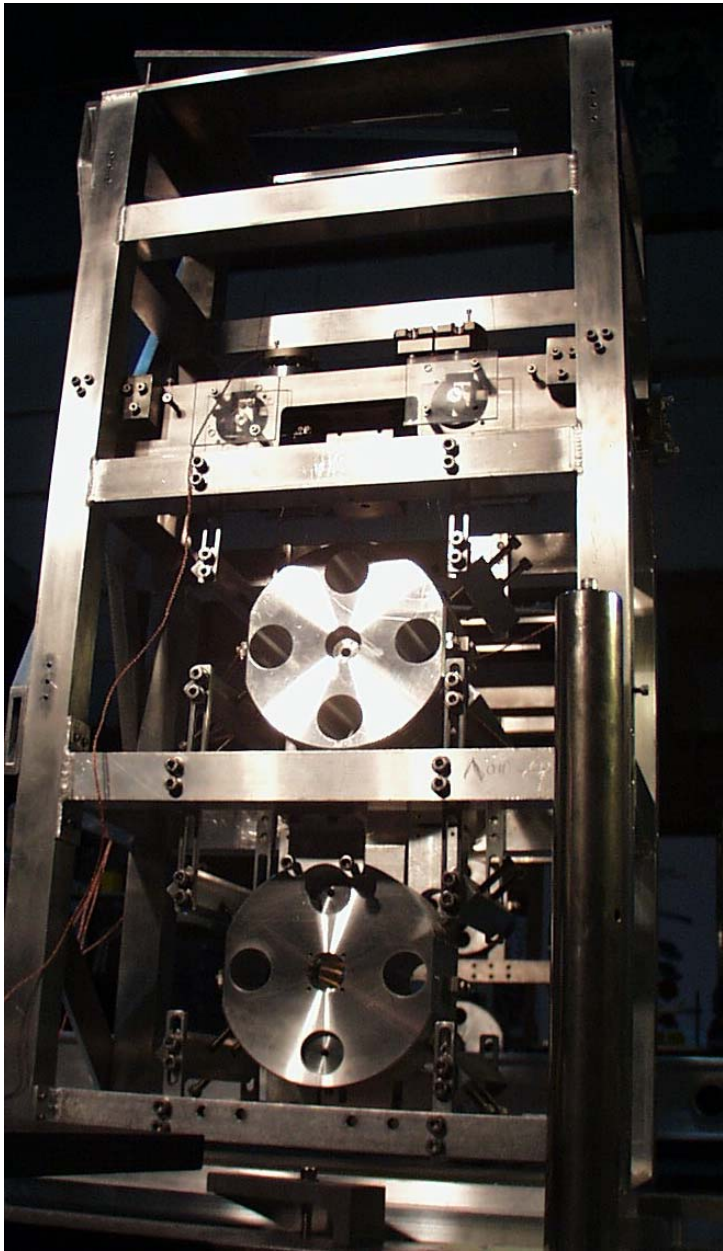

LIGO-G030386-03

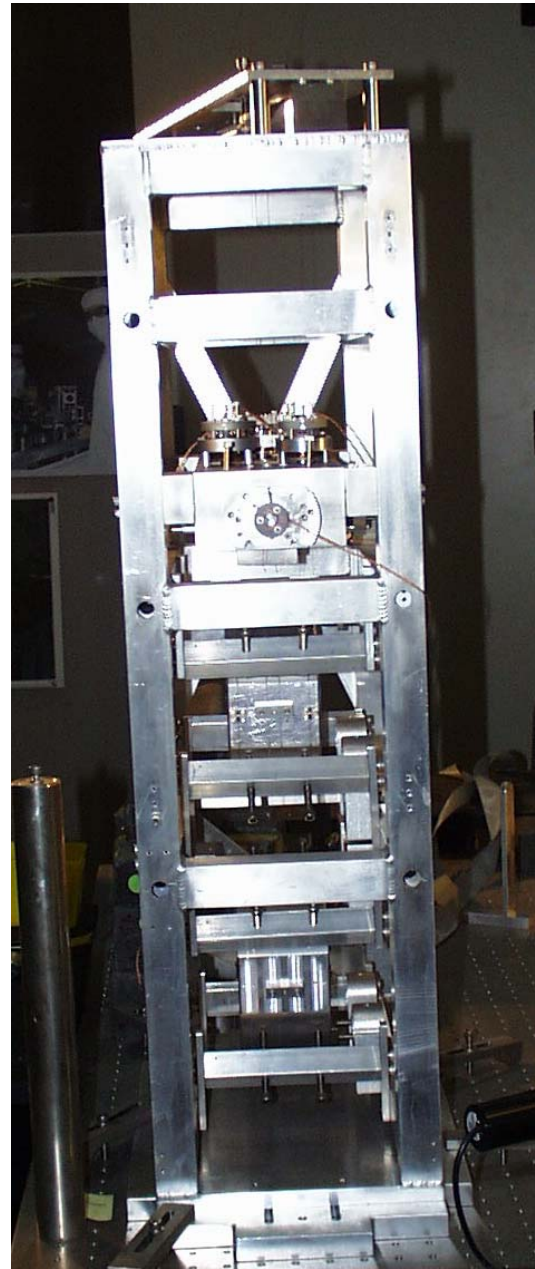

ALUKGLA0031aAUG03

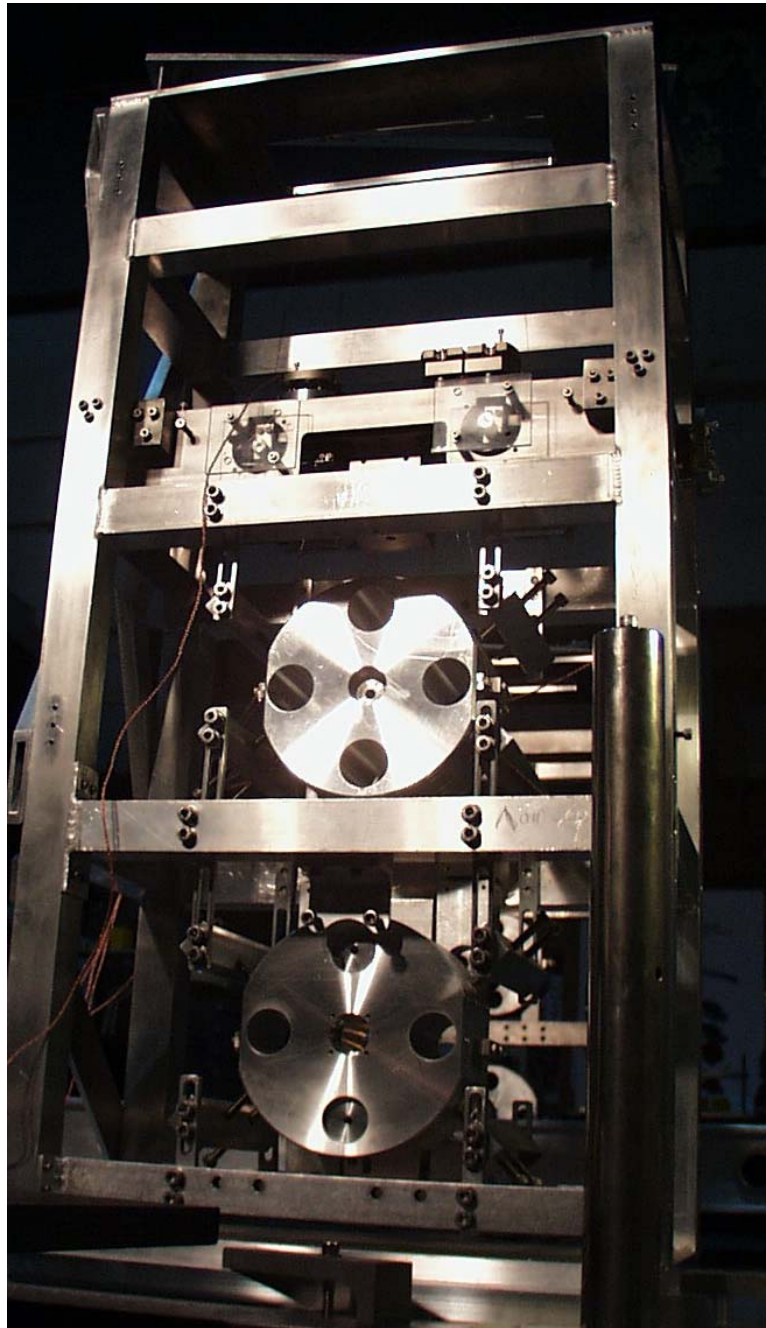

LIGO-G030386-03



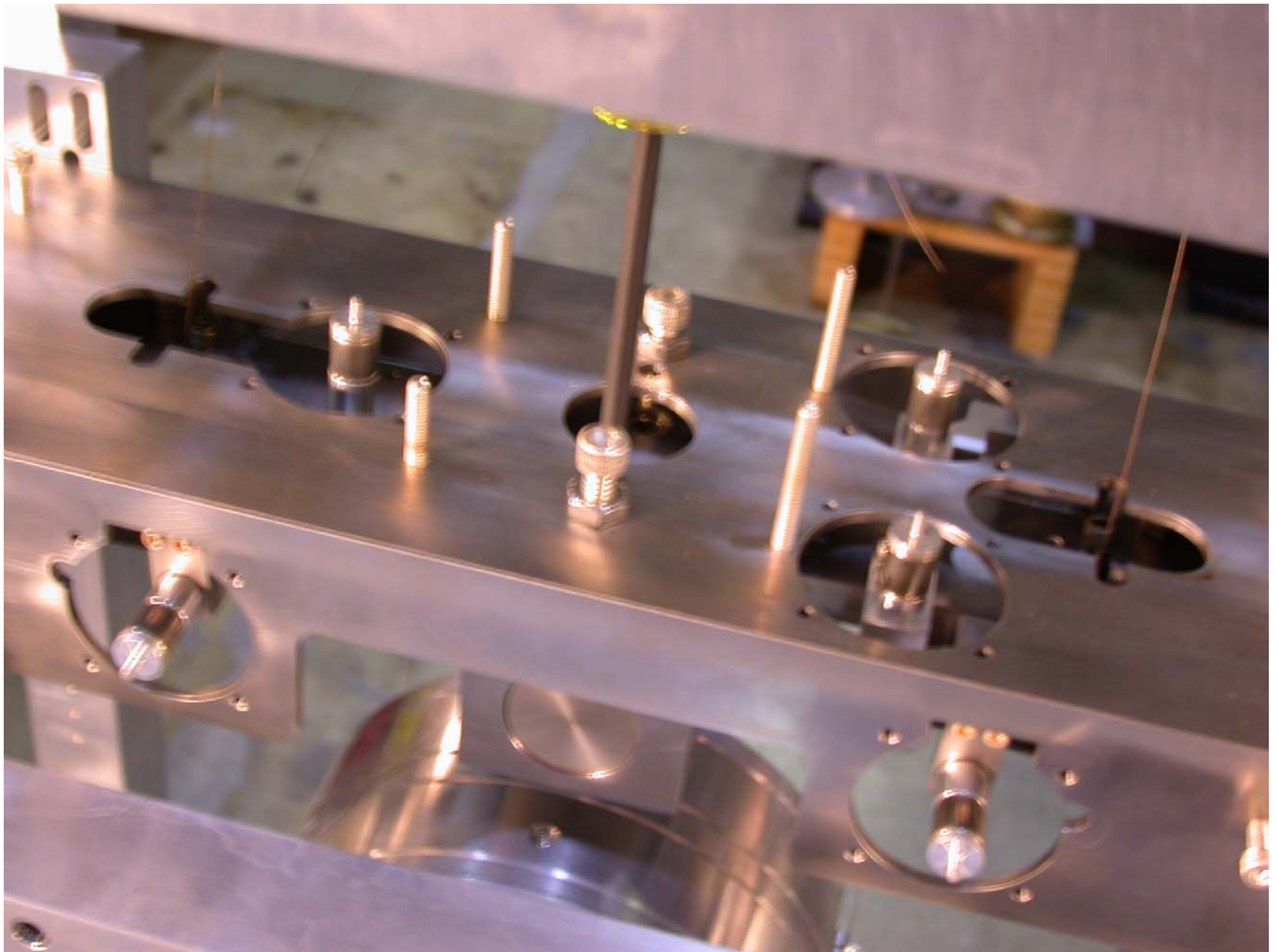

LIGO-G030386-03

ALUKGLA0031aAUG03

24

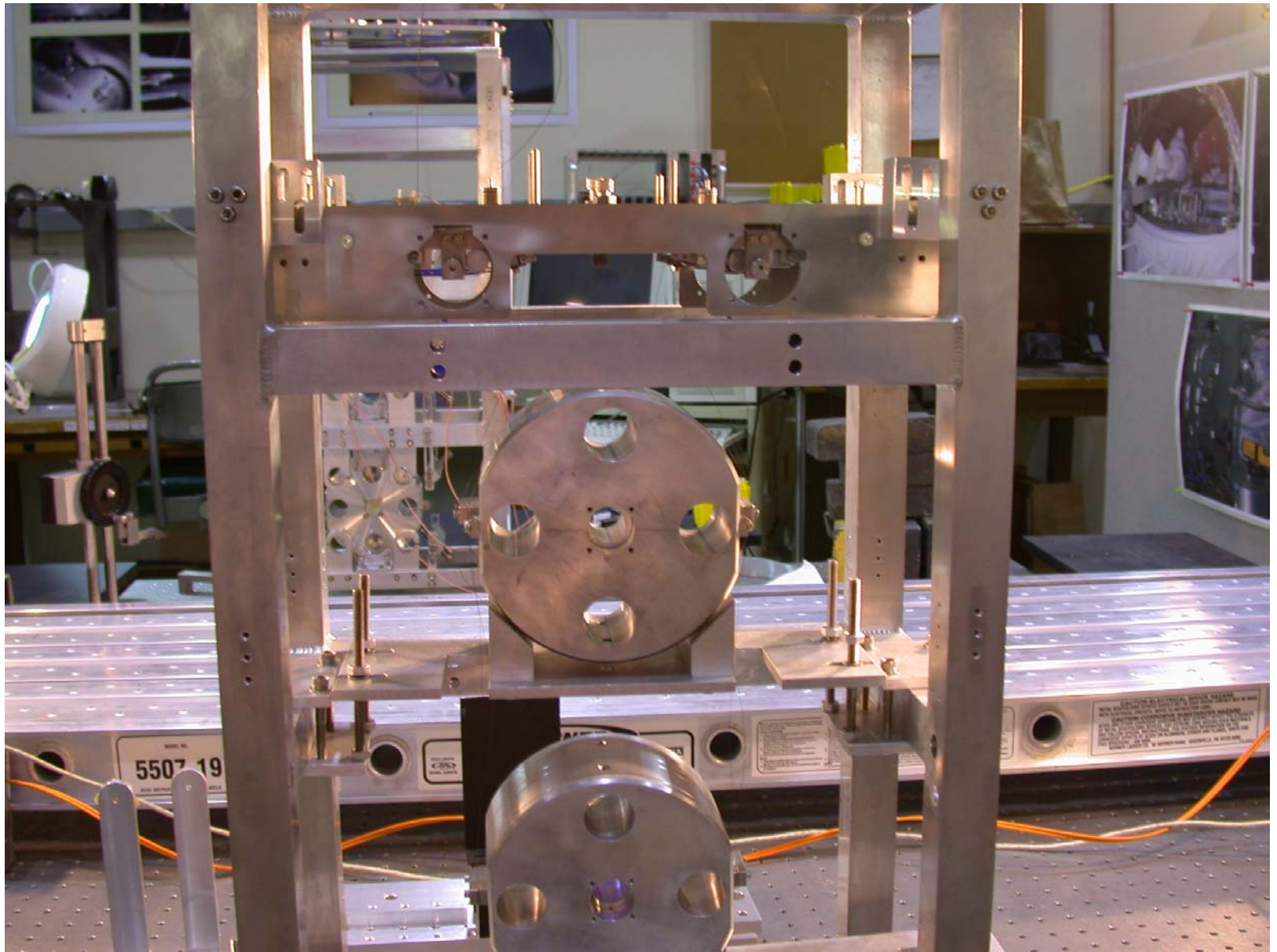



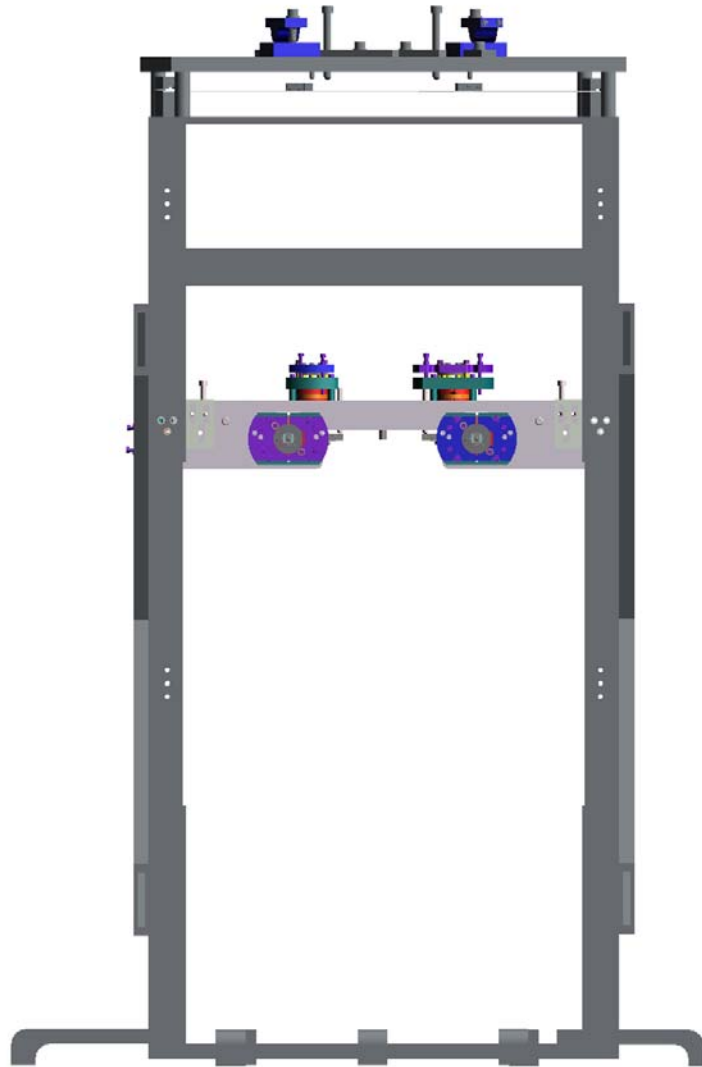





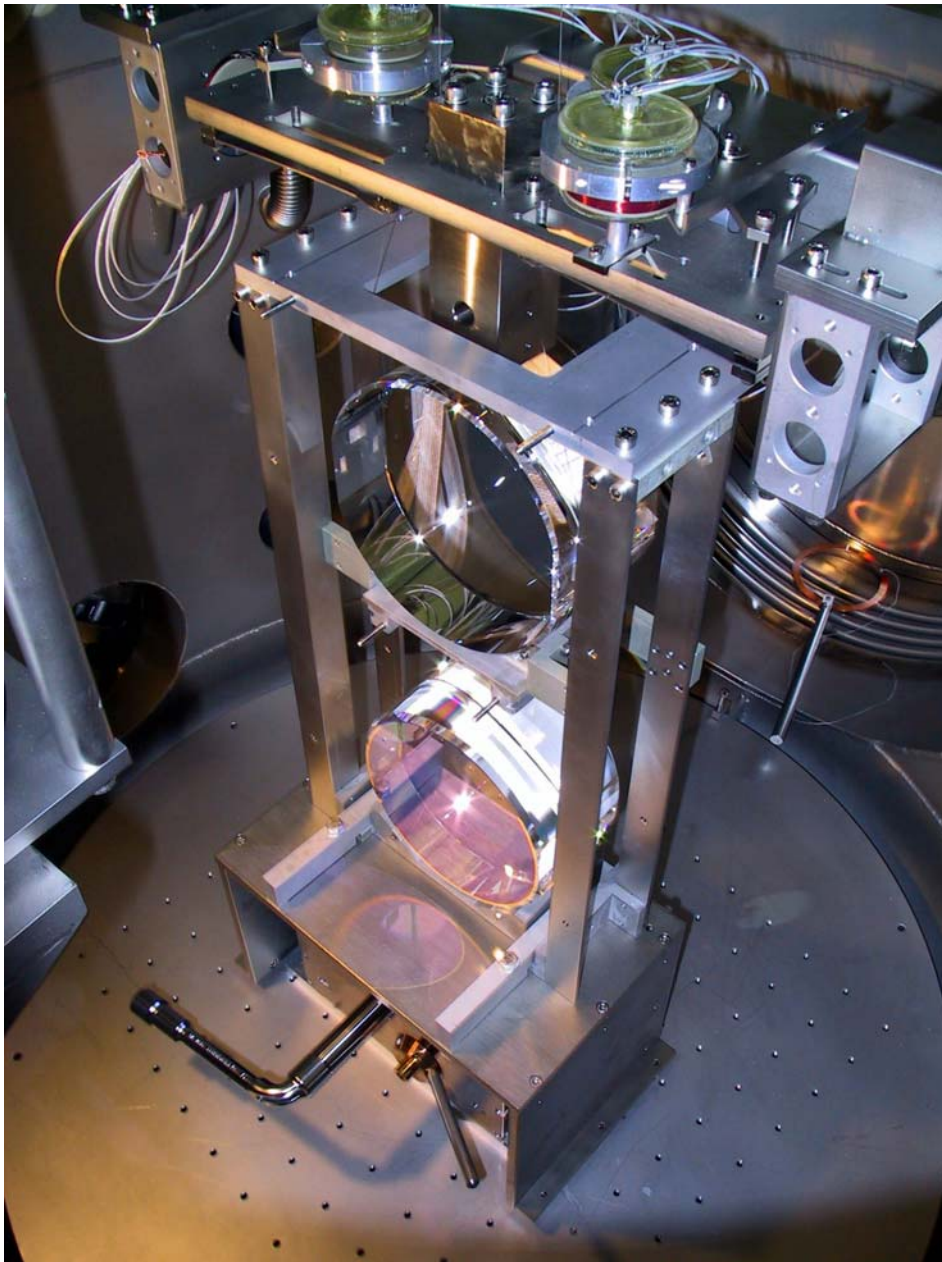

LIGO-G030386-03

ALUKGLA0031aAUG03

28

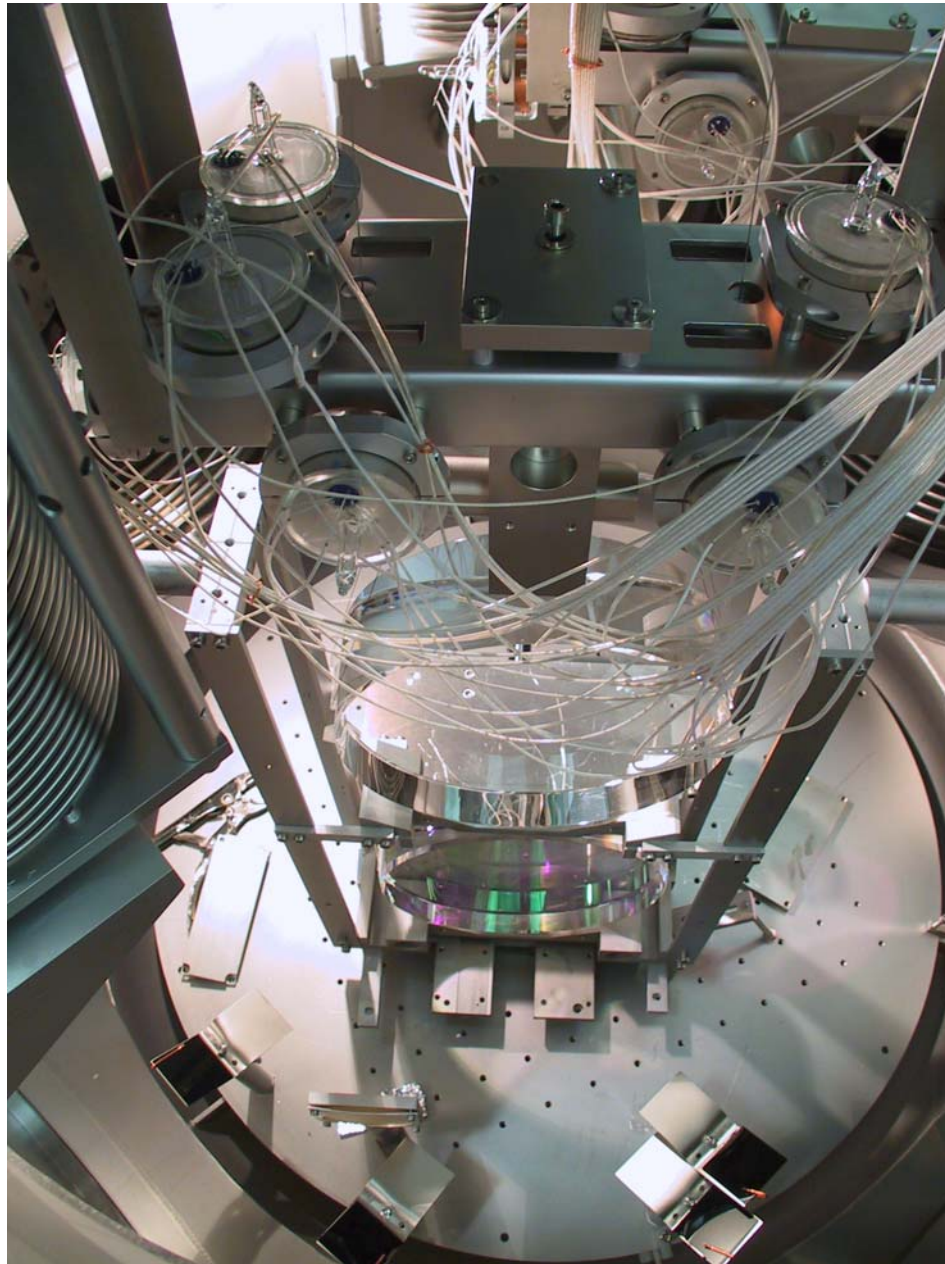

LIGO-G030386-03

ALUKGLA0031aAUG03

29



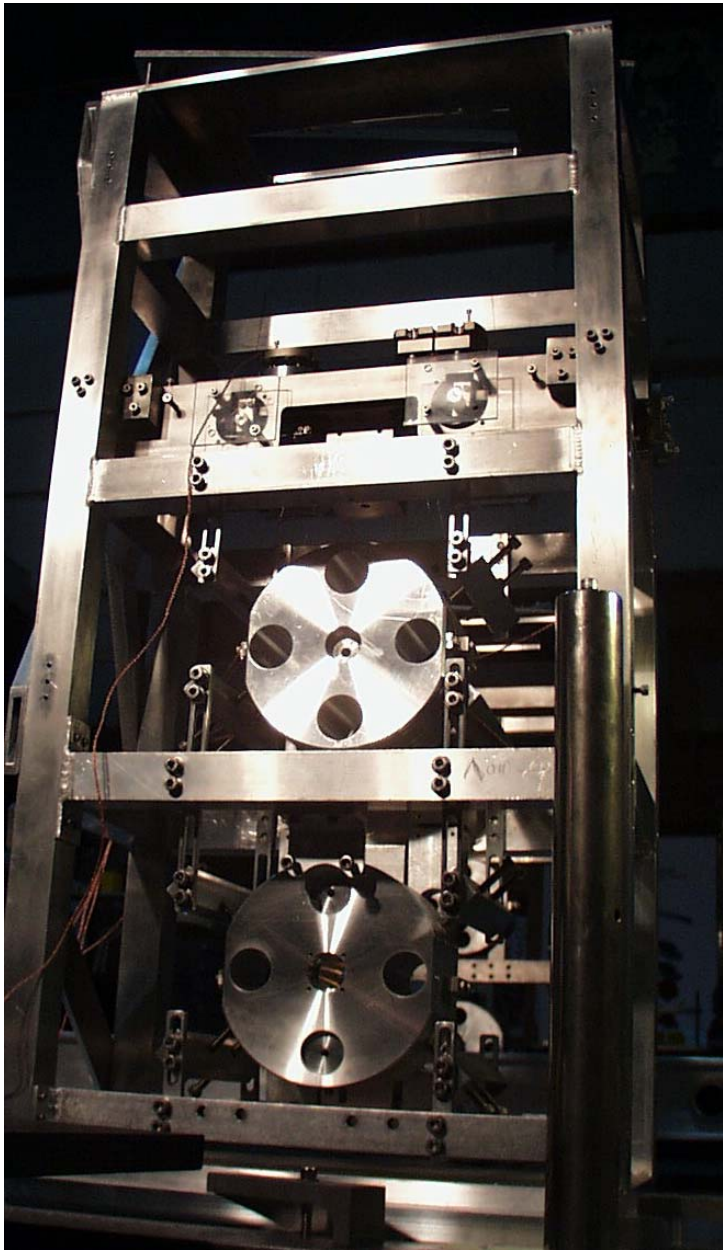

LIGO-G030386-03

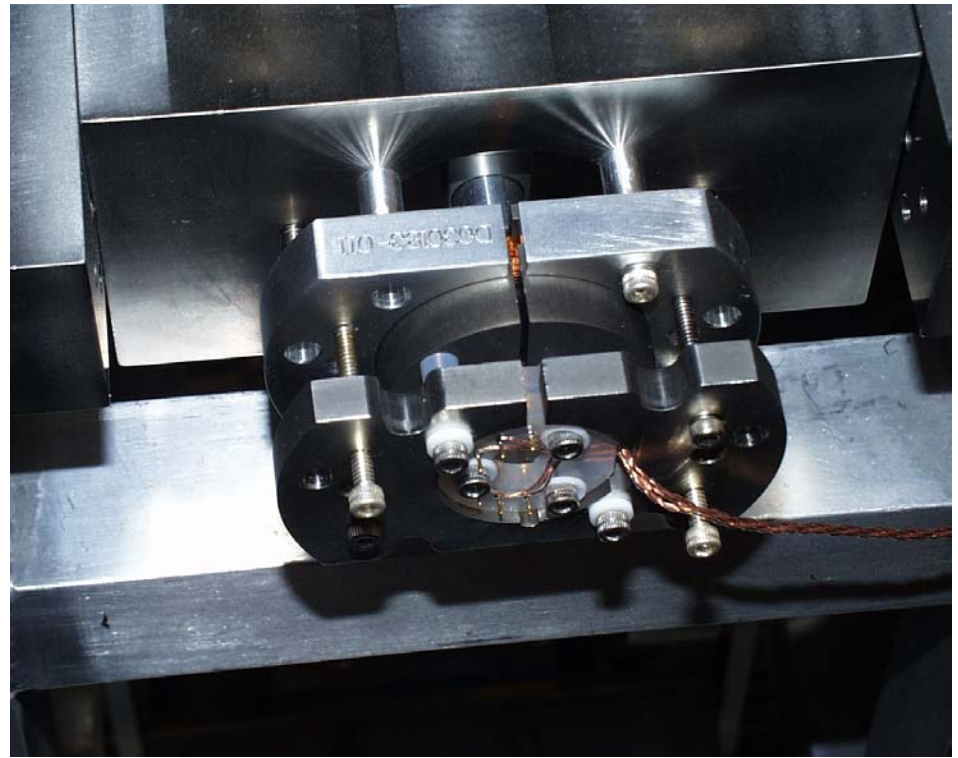

ALUKGLA0031aAUG03

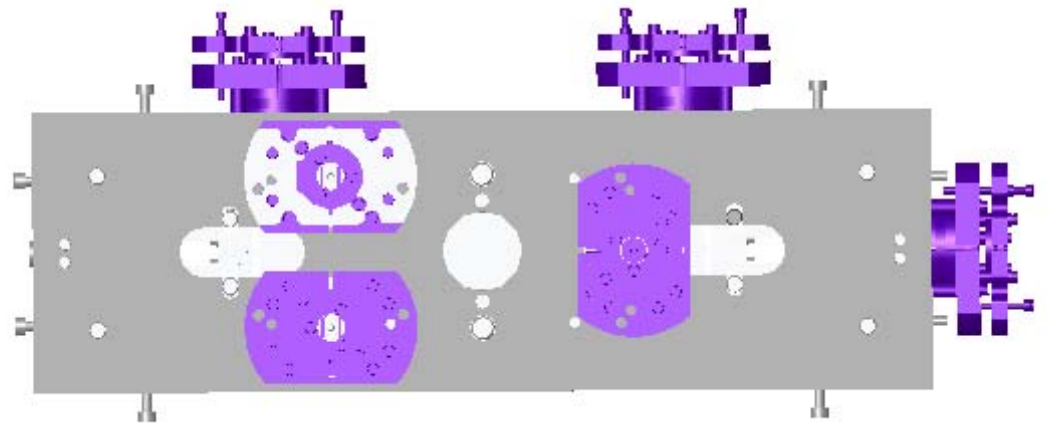
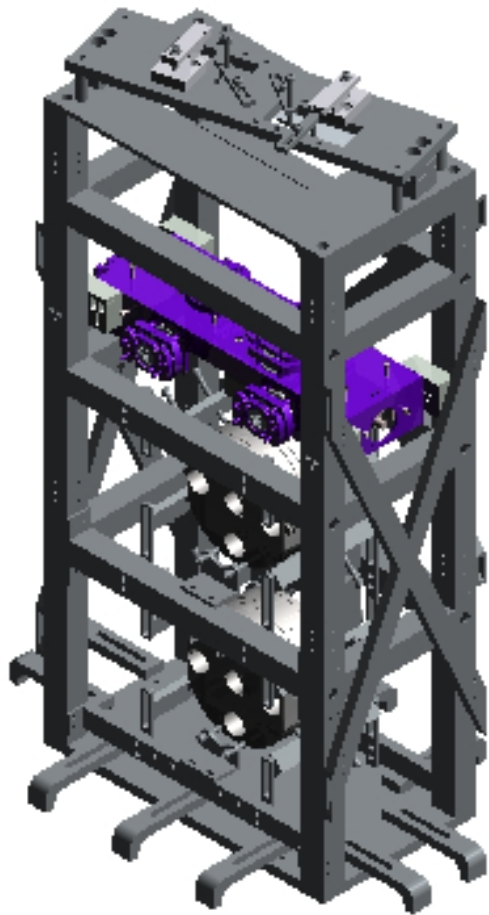

LIGO-G030386-03

SWITCH TO TALK ON COILS & ECDs



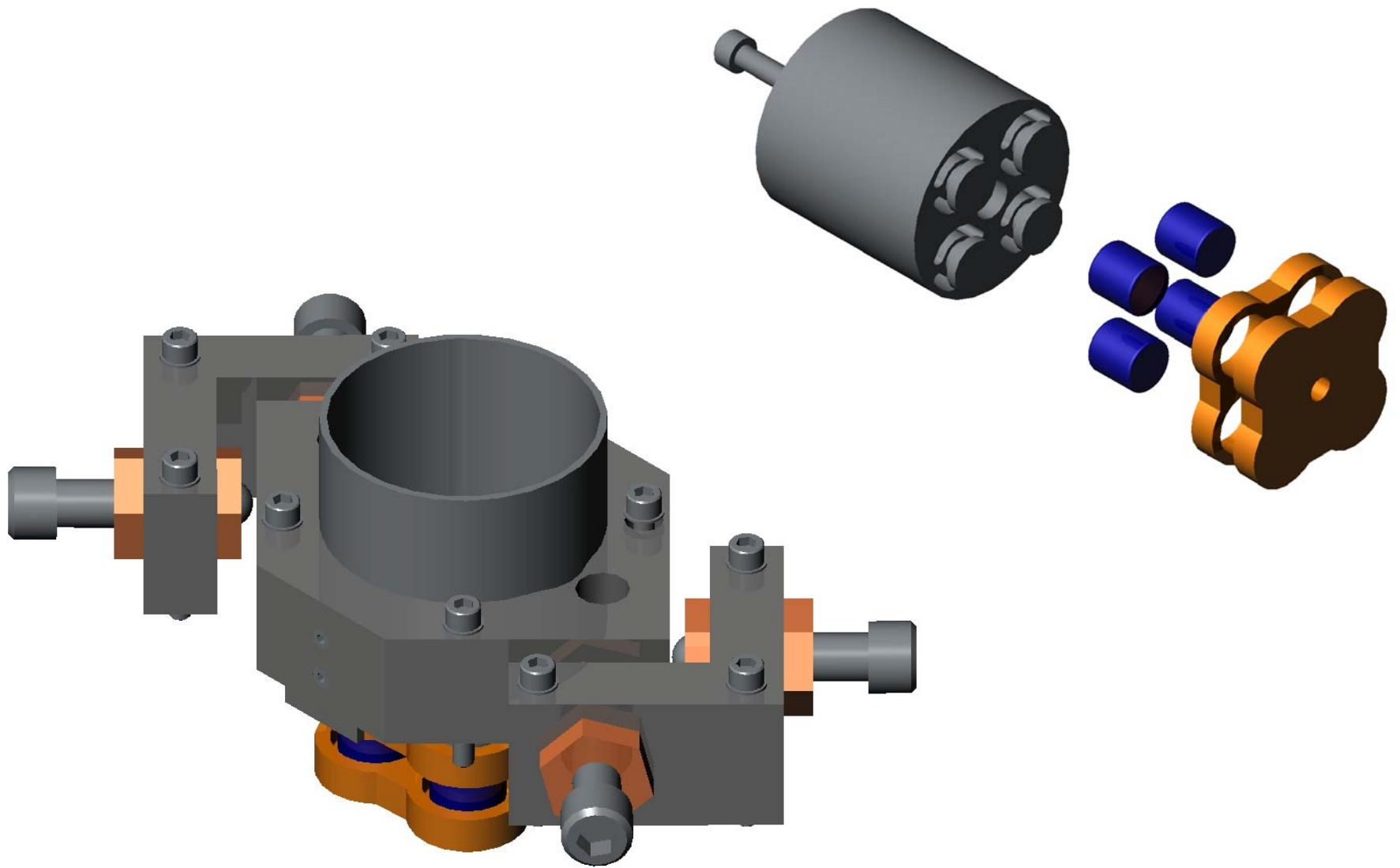

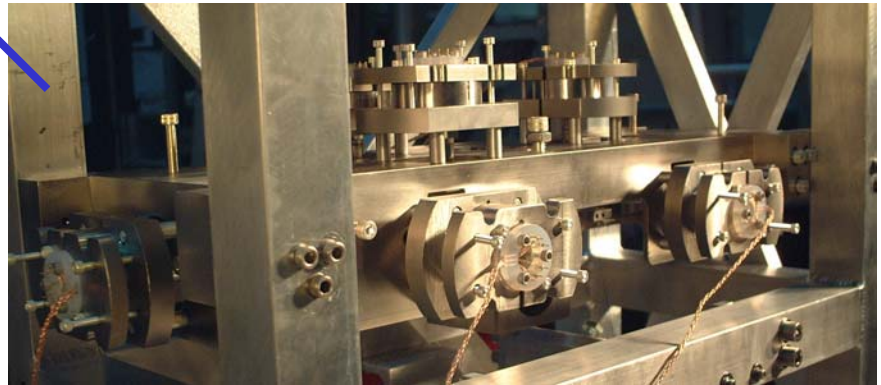
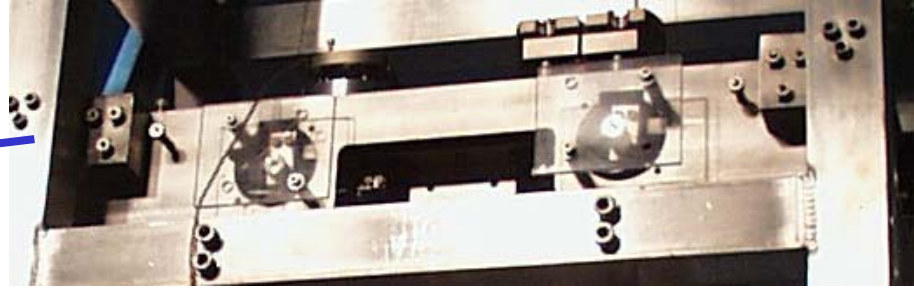
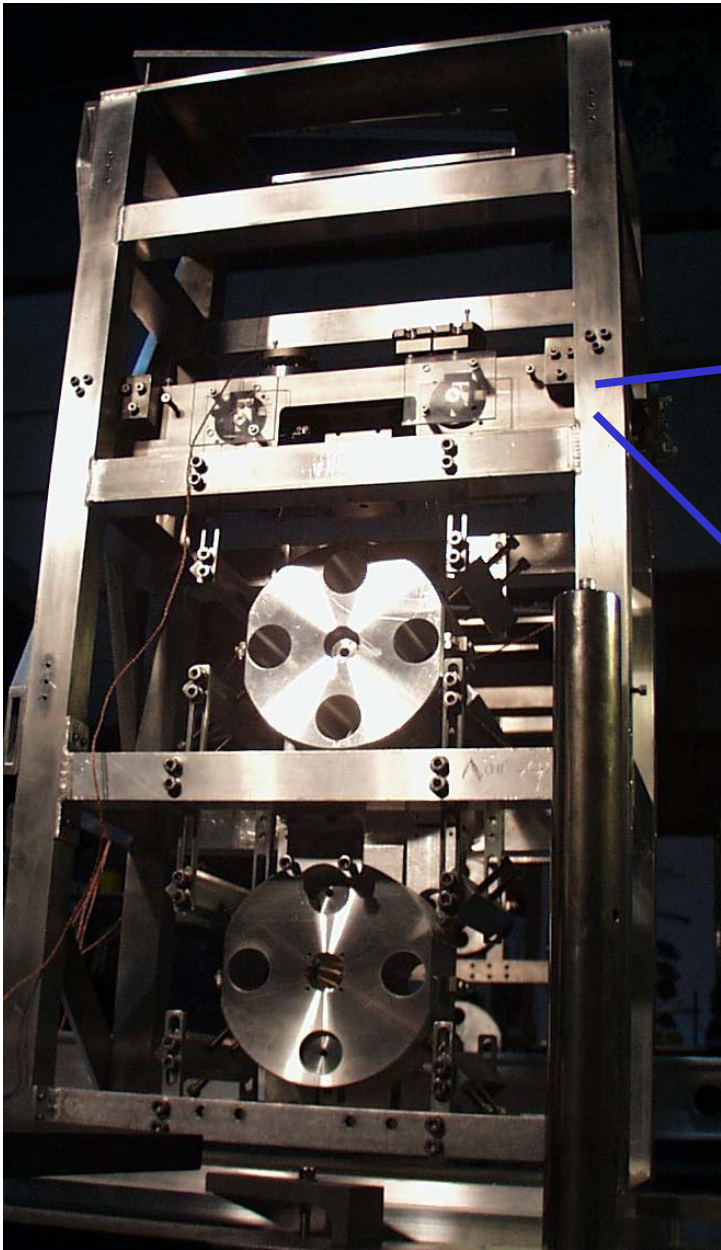

LIGO-G030386-03

ALUKGLA0031aAUG03



