



*LIGO Laboratory*

T030035-00

*ADVANCED LIGO*

Feb. 26, 2003

LASTI PUMP STATION  
Operation Manual  
SD

K. Mailand

Distribution of this document:  
HEPI/SEI Group

This is an internal working note of the LIGO Project.

**California Institute of Technology**  
LIGO Project – MS 18-34  
1200 E. California Blvd.  
Pasadena, CA 91125  
Phone (626) 395-2129  
Fax (626) 304-9834  
E-mail: [info@ligo.caltech.edu](mailto:info@ligo.caltech.edu)

**Massachusetts Institute of Technology**  
LIGO Project – NW17-161  
175 Albany St  
Cambridge, MA 02139  
Phone (617) 253-4824  
Fax (617) 253-7014  
E-mail: [info@ligo.mit.edu](mailto:info@ligo.mit.edu)

**LIGO Hanford Observatory**  
P.O. Box 1970  
Mail Stop S9-02  
Richland WA 99352  
Phone 509-372-8106  
Fax 509-372-8137

**LIGO Livingston Observatory**  
P.O. Box 940  
Livingston, LA 70754  
Phone 225-686-3100  
Fax 225-686-7189

<http://www.ligo.caltech.edu/>

<b>1</b>	<b><i>Introduction.....</i></b>	<b>3</b>
<b>2</b>	<b><i>Major Components (D030051-A LASTI LAYOUT.dwg ).....</i></b>	<b>3</b>
<b>3</b>	<b><i>General operation of system.....</i></b>	<b>4</b>
<b>4</b>	<b><i>List of drawings.....</i></b>	<b>4</b>
<b>5</b>	<b><i>Fluid Pressure Sensors.....</i></b>	<b>4</b>
<b>6</b>	<b><i>Fluid Distribution Manifold (s).....</i></b>	<b>5</b>
<b>7</b>	<b><i>Alignment of Motor and Pump:.....</i></b>	<b>6</b>
<b>8</b>	<b><i>Fluid Reservoir.....</i></b>	<b>7</b>
<b>8.1</b>	<b><i>Fluid Reservoir Level Sensor.....</i></b>	<b>7</b>
<b>8.2</b>	<b><i>Filler Cap.....</i></b>	<b>7</b>
<b>8.3</b>	<b><i>Reservoir Filter.....</i></b>	<b>7</b>
<b>9</b>	<b><i>System Filter.....</i></b>	<b>7</b>
<b>10</b>	<b><i>Accumulator [2] [Bladder Pressurizing].....</i></b>	<b>8</b>
<b>11</b>	<b><i>LASTI: Installation Layout Drawing.....</i></b>	<b>8</b>

# 1 Introduction

This document describes the general operation of the LASTI PUMP STATION. The set up layout is similar to the test CIT layout. The LASTI pump station has two R/C assemblies. The Resistor/Capacitor assemblies are valved in a way that allows one, or both together to operate. These assemblies smooth the flow of the fluid and reduce pressure ripple effects.

## 2 Major Components (D030051-A LASTI LAYOUT.dwg Shown Below)

Reservoir

Motor

Motor Controller

Pump [Screw Type]

Filters [2]

Accumulator / Resistor Assemblies[2]

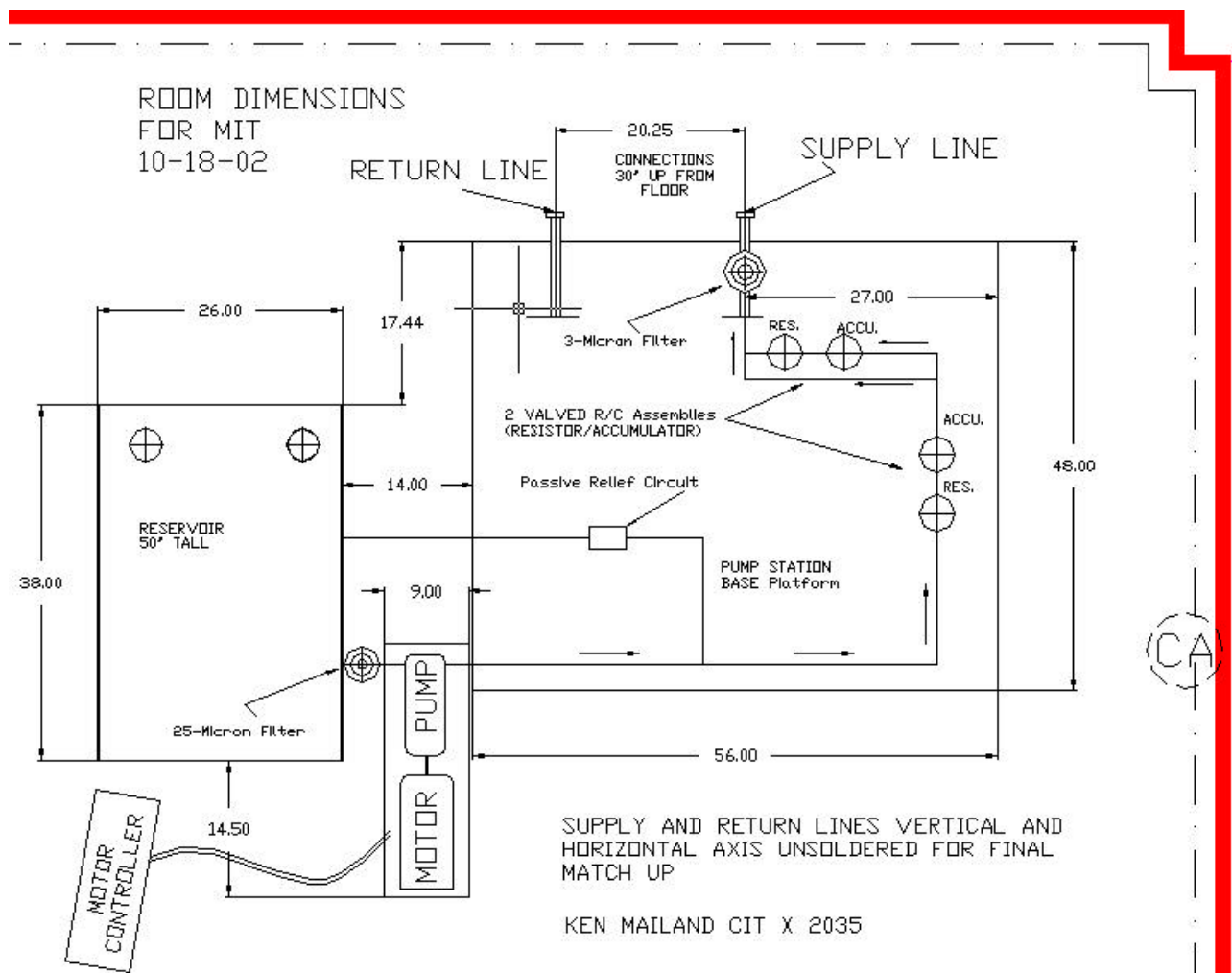

Figure 1 The Pump Room Layout at LASTI

### 3 General operation of system



































At start up a check of the valve positions should be made to be sure the desired flow path is correct. The motor has a speed control regulating the current frequency that will control the pump speed and the system pressure. The psi sensors will feed into a control box and then to the motor speed controller to provide a constant pressure thru a range of fluid temperature/viscosity changes.

There is a passive fluid bypass circuit, which is preset to a pressure just above the highest operational pressure requirement. The bypass reroutes the fluid back to the reservoir if there is a blockage some were in the system.

There is a small bleed valve located on the top of each resistor housing [2] the purpose is to allow the trapped air which will rise to this 'high point' to be released out of the system.

### 4 List of drawings

The following is a list of PUMP STATION component shop drawing, with some assemblies and layouts is in the DCC.

 D030098-A SECONDARY MANIFOLD ASSEMBLY.dwg	 D030057-A TEST LOAD ASSEMBLY.dwg
 D030097-A PUMP STATION LAYOUT.dwg	 D030056-A PUMP GUIDE SLEEVE CIG AND SCR.dwg
 D030093-A RESISTOR CAP.DWG	 D030055-A PUMP ALIGNMENT TOOL.dwg
 D030090-A MOTOR BASE, LEG & FOOT.DWG	 D030054-A SCREW PUMP SPACER.dwg
 D030088-A COVER, TEMP., MANIFOLD HOLES.dwg	 D030053-A BRACKET LEVEL SENSOR ROD.dwg
 D030074-A MAIN MANIFOLD ASSEMBLY.dwg	 D030052-A ROD, LEVEL SENSOR.dwg
 D030072-A RESISTOR ASSEMBLY.dwg	 D030051-A LASTI PUMP ROOM LAYOUT.dwg
 D030071-A VALVE MANIFOLD, SERVO VALVE.dwg	 D030050-A RESERVOIR, FLUID.dwg
 D030070-A KNOB MODIFICATION.dwg	 D020430-A ADAPTOR, SENSOR ISOLATING.dwg
 D030069-A RESISTOR WASHER.dwg	 D020388-A HYDRAULIC MANIFOLD, MOUNT MAIN.dwg
 D030068-A COVER MANIFOLD VALVE HOLES TEMP.dwg	 D020387-A HYDRAULIC MANIFOLD, CONNECTORS.dwg
 D030067-A PUMP MOUNT ADAPTOR MODIFICATION.dwg	 D020386-A HYDRAULIC MANIFOLD MOUNT, SECONDARY.dwg
 D030066-A RESERVOIR AND MOTOR BASE.dwg	 D020385-A MANIFOLD ATTACHMENT FITTING [ACCUMULATOR].dwg
 D030064-A RUN, TUBING FRAME.dwg	 D020349-A -MAIN HYDRAULIC MANIFOLD, CHAMBER.dwg
 D030063-A BASE, RESISTOR INTERNAL.dwg	 D020348-A HYDRAULIC MANIFOLD, CHAMBER, SECONDARY new.dwg
 D030059-A SLEEVE, RESISTOR.dwg	 D030087-A HEPI FLOAT LEVEL SENSOR SPEC.pdf
 D030058-A PUMP ADAPTOR LAYOUT WORKSHEET.dwg	 D030086-A HEPI FLOAT LEVEL SENSOR INSTALLATION.pdf

### 5 Fluid Pressure Sensors

There are fluid pressure sensors located at the pump station [3] and in the main distribution manifold [2]. The electrical pressure sensors at the pump station are 0-300psi range. One is located near the pump two others are just after the R/C stages. The main distribution manifold has two sensors 0-500 psi range. The two at the manifold are 'O' ring seal type the pump station sensors are NPT type.

## 6 Fluid Distribution Manifold (s)

There is a main manifold. (Fig 2) and a secondary manifold (Fig 3) [2] to distribute the fluid to the actuator system.

The manifolds are made of stainless steel and are of welded construction. The main manifold has two accumulators one in both the supply side and the return side. The secondary manifolds are just splitters for the fluid flow. The manifolds are on mount brackets and are secured to the adjacent structure by one 1/2" threaded bolt.

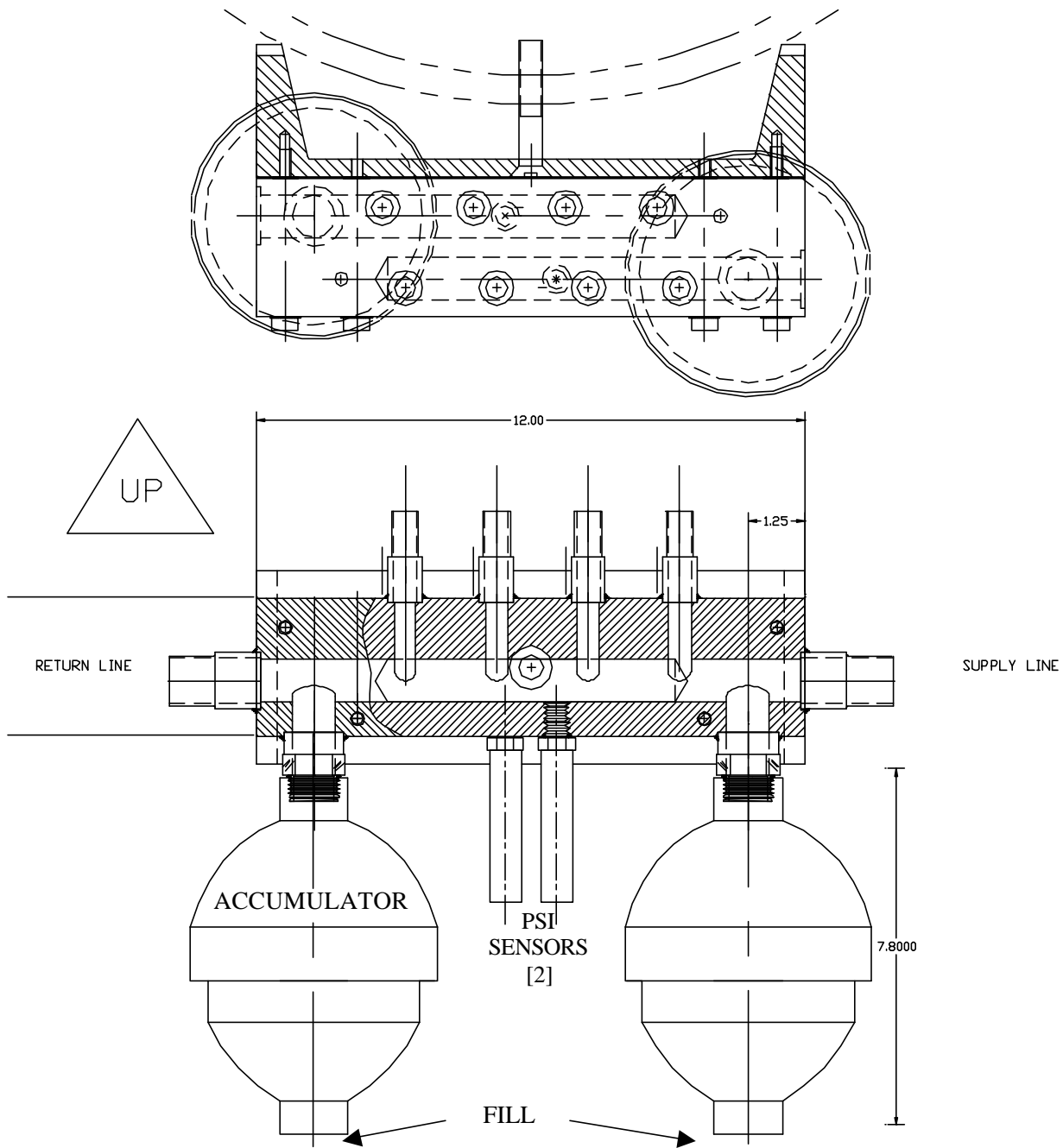

**Figure 4** Front and Top view of Manifold Assembly

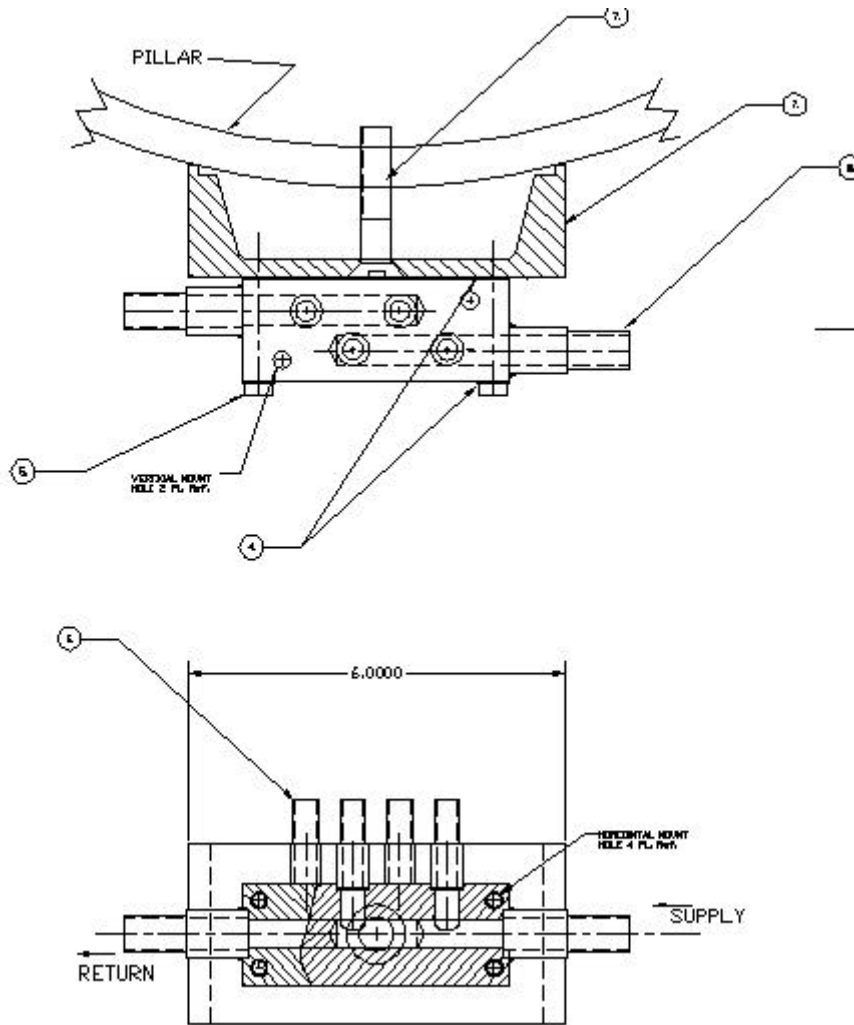

**Figure 5** Front and Top view of Manifold Assembly

## 7 Alignment of Motor and Pump:

The motor and pump are individually mounted on a base plate. The base plate is adjustable in height and level. The motor is driving the pump thru a 'Lovejoy' jaw type coupling. The motor has been precision balanced and also the coupling. The alignment of the pump to the motor is important and should not exceed the tolerance of the coupling. The angular alignment should not exceed  $\frac{1}{2}$  degree and the vertical and horizontal center not be offset more than .012 inch.

There is an alignment tool to do the initial alignment the tool is used as a guide on the external portion of the pump and motor a follow-up with a dial indicator should be done.

## 8 Fluid Reservoir

### 8.1 Fluid Reservoir Level Sensor

The fluid reservoir has a fluid level sensor built in at the top adjacent to the filler cap location. The level sensors purpose is to shut down the motor [pump] in the event of a low fluid condition [possible leak].

The level sensor is a float type and should be adjusted following the instructions on engineering documents: D030086-A and D030087-A, which are on file in the DCC.

### 8.2 Filler Cap

The reservoir has a filler cap which is 'non breathing' and a desiccant breather filter, which will remove water from the air. The filter is a screw on type and is located on the top of the reservoir opposite the filler cap.

The filter color will change from blue to red/pink color when the maximum amount of water is trapped in the filter, at this point the filter should be changed.

### 8.3 Reservoir Filter

In addition there is a fine mesh filter in the reservoir filler and one each in the supply and return line internally mounted. The flow capacity of the fine mesh internal filters is 20 gpm, so these will not affect the free flow of the fluid.

## 9 System Filter

The fluid is good for thousands of hours of continuous operation of the system. The fluid is filtered by a 25-micron spin on filter in before the pump inlet and a 3-micron filter at the exit of the pump station. The filters have internal bypass valves that allow fluid to cross thru the filter head if there is an internal blockage of the fluid. The capacity of the filters is large and should last at least two years of normal continuous operation.

## 10 Accumulator [2] [Bladder Pressurizing]

There is an accumulator at each of the r/c assemblies, these are screwed on, and have an 'O' ring seal at the neck. The accumulators should be pressurized with the system turned off and set at approximately .60 to .90 of the operating pressure in the line adjacent to the accumulator. The accumulators are pressurized with nitrogen and use a standard bike tire tube fitting. A special filler assembly with a gage and pressure release button is used for this purpose. The accumulator is filled just a few psi over the required level and psi is released to the desired level with the release button. Note the volume is small in the accumulator bladder and removing the pressure gage should be done so as not to allow any pressure to escape, or the internal psi will not be accurately set. See in (FIG 1) 'Fill' above.

## 11 LASTI: Installation Layout Drawing

DCC Drawing Number - D030051-A LASTI PUMP ROOM LAYOUT.dwg

Ken Mailand CIT –LIGO 1-626-395-2035