

of PARSONS, they are issued only with the borrower's expressed written agreement that they will copy other notes, except by written consent from PARSONS to the borrower.

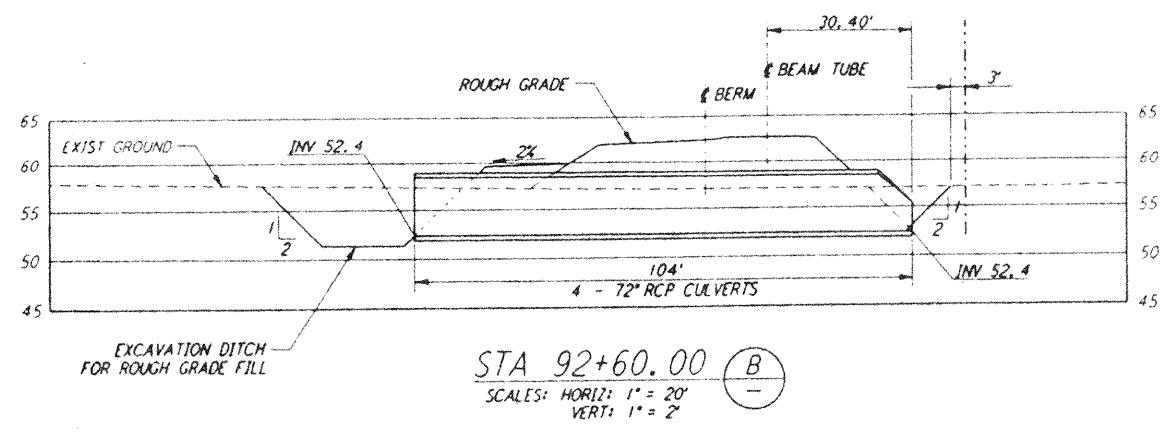

**NOTES:**  
 1. SEE SHEET RG-C-002 FOR GENERAL NOTES, LEGEND AND ABBREVIATIONS.  
 2. SEE SHEET RG-C-004 FOR TYPICAL SECTIONS AND DETAILS.

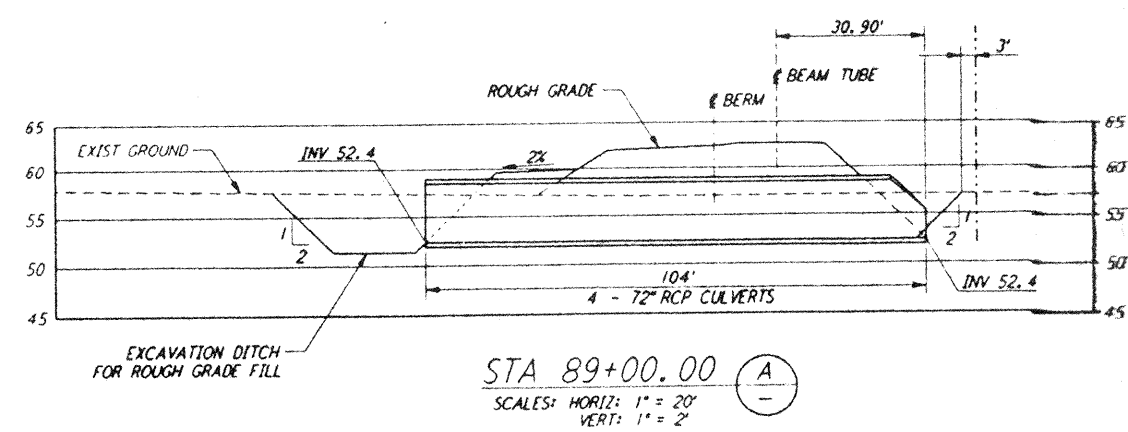
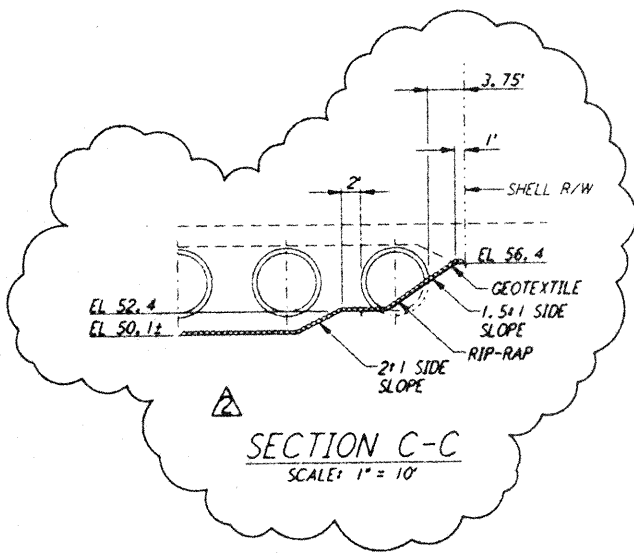
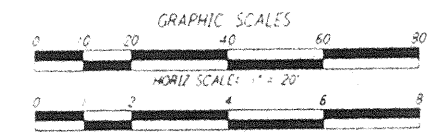
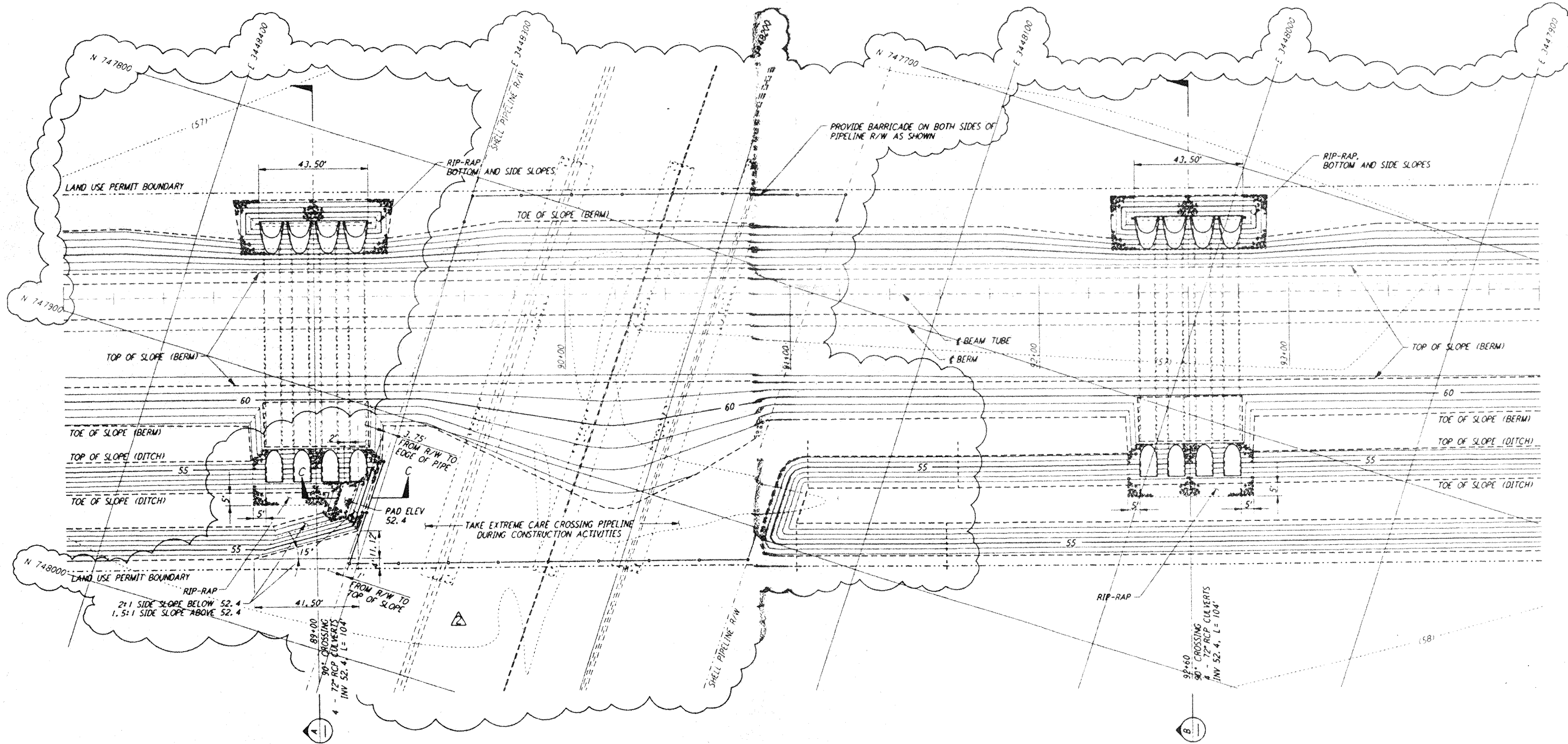

**LIGO-0961734-02-0**

NO.	DATE	APPRO BY	DESCRIPTION OF REVISION	NO.	DATE	APPRO BY	ISSUED FOR
9				9			
8				8			
7				7			
6				6			
5				5			
4				4			
3				3	5/24/98	TM	CHANGE ORDER NO. 6
2	5/24/98	TM	REVISED GRADING & PIPELINE R/W LOCATION ADDED SECTION, REVISOR GRID COORDINATES	2	11/1/95	TM	ISSUED FOR CONSTRUCTION
1	11/1/95	TM	NO REVISIONS	1	8/28/95	TM	ISSUED FOR BID

DATE	BY
8/11/95	
8/95	WFB
8/28/95	MCP
8/28/95	WFB
8/28/95	WFB

**PARSONS**  
 100 WEST WALNUT STREET  
 PASADENA, CALIFORNIA

**LIGO**  
 CALIFORNIA INSTITUTE OF TECHNOLOGY  
 MASSACHUSETTS INSTITUTE OF TECHNOLOGY

**LASER INTERFEROMETER  
 GRAVITATIONAL-WAVE OBSERVATORY  
 ROUGH GRADING - LIVINGSTON, LA**

TITLE	ROUGH GRADING SOUTHWEST ARM CULVERT GENERAL ARRANGEMENTS	SCALE	AS NOTED	CONTRACT NUMBER	PP150969	PROJECT NUMBER	8094
SHEET NUMBER	<b>RG-C-028</b>	REVISIONS					