

MC3

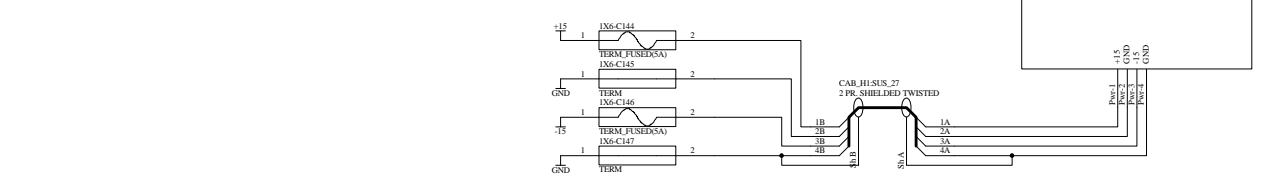

SM1

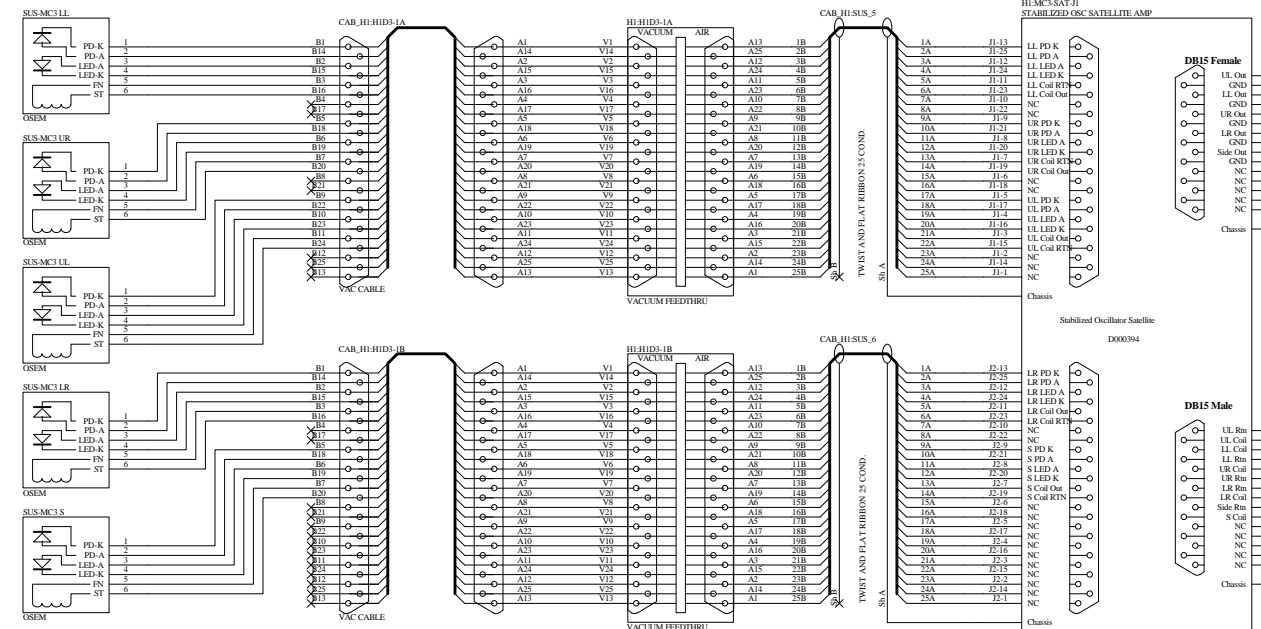
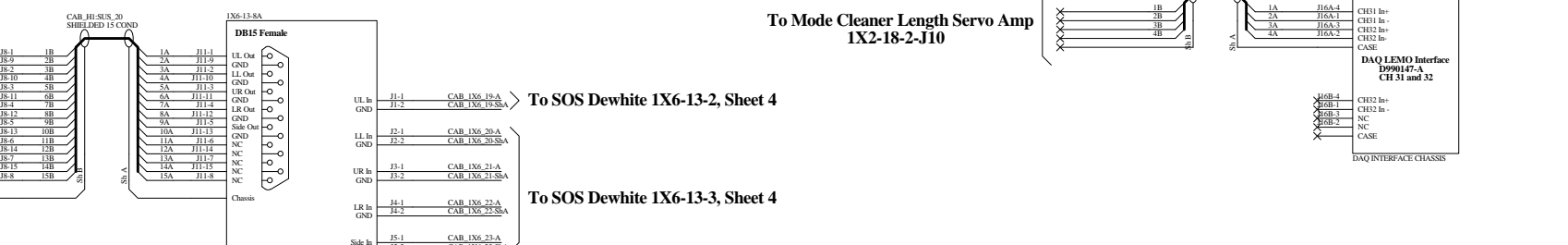
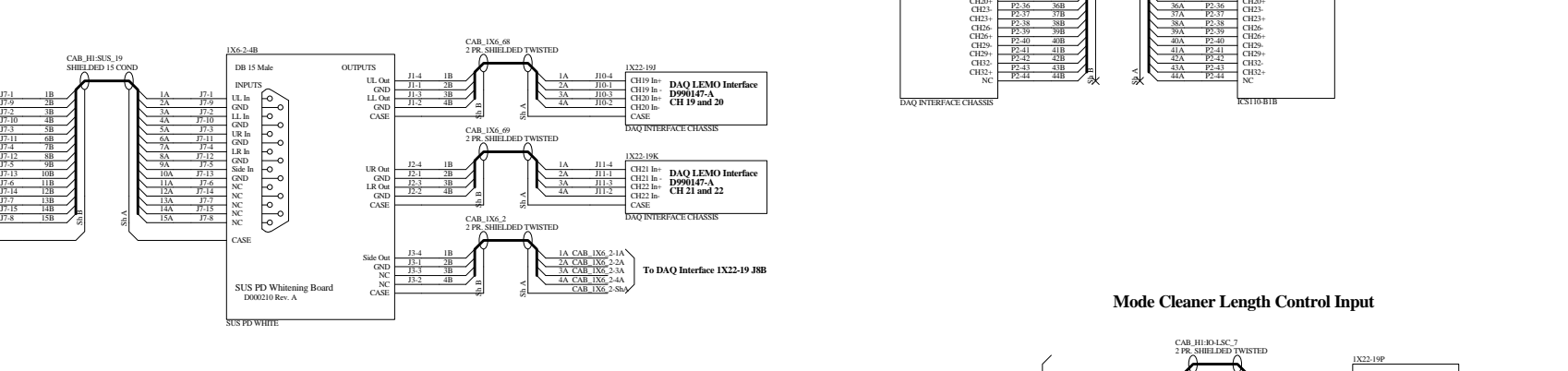
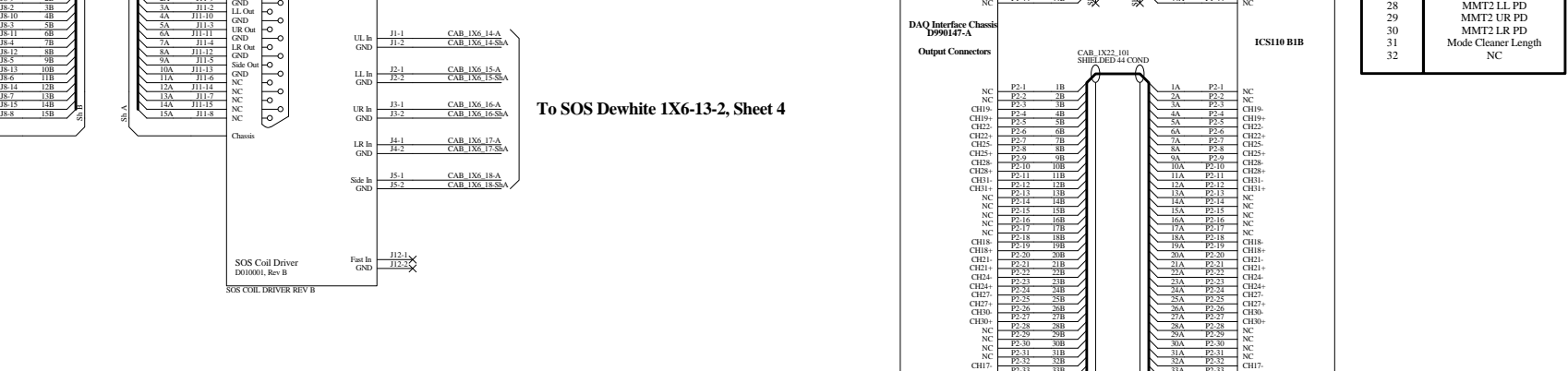
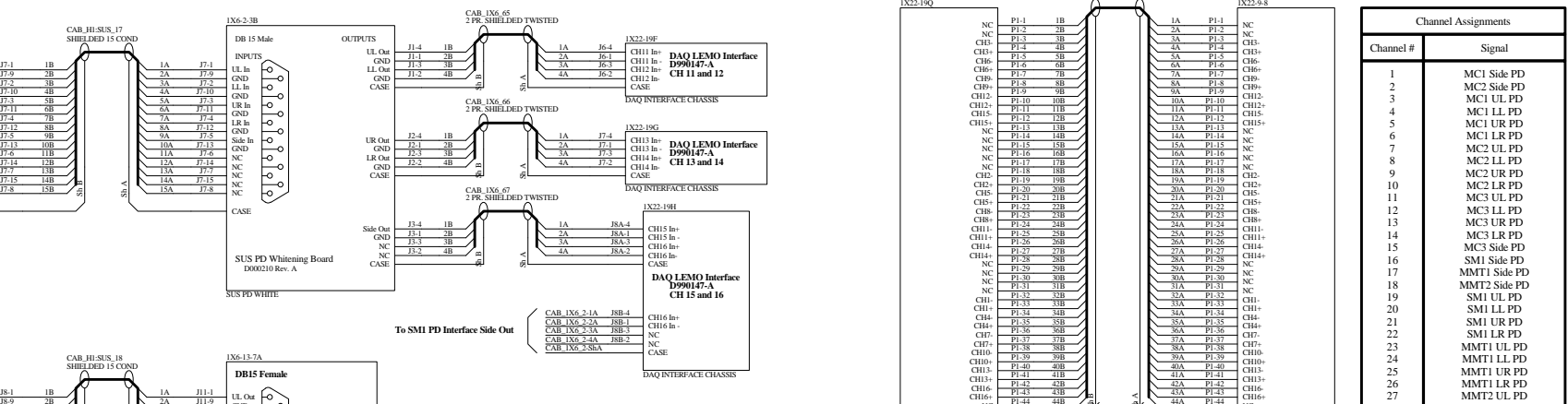
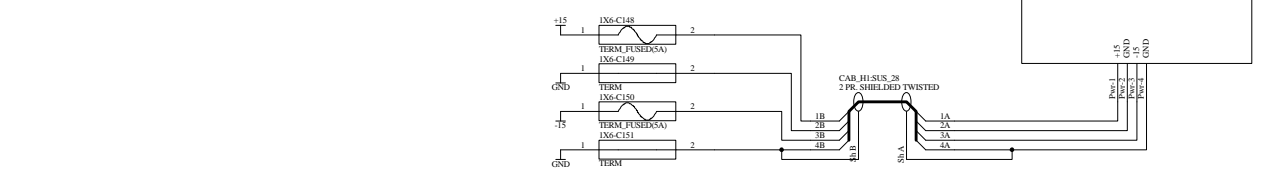
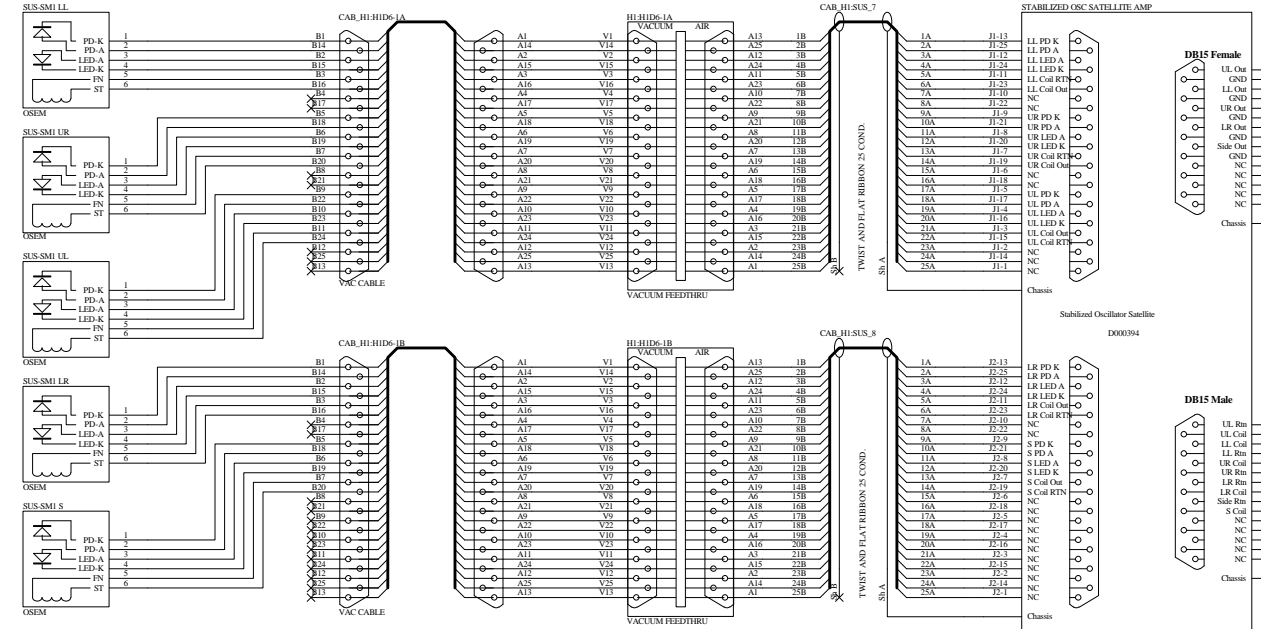

Channel #	Signal
1	MC1 Side PD
2	MC2 Side PD
3	MC1 UL PD
4	MC1 LL PD
5	MC1 UR PD
6	MC1 LR PD
7	MC2 UL PD
8	MC2 LL PD
9	MC2 UR PD
10	MC2 LR PD
11	MC3 UL PD
12	MC3 LL PD
13	MC3 UR PD
14	MC3 LR PD
15	MC3 Side PD
16	MMT1 Side PD
17	MMT1 UL PD
18	MMT1 LL PD
19	SM1 UL PD
20	SM1 LL PD
21	SM1 UR PD
22	SM1 LR PD
23	MMT2 UL PD
24	MMT2 LL PD
25	MMT2 UR PD
26	MMT2 LR PD
27	MMT2 Side PD
28	MMT2 UL PD
29	MMT2 LL PD
30	MMT2 UR PD
31	MMT2 LR PD
32	Mode Cleaner Length NC

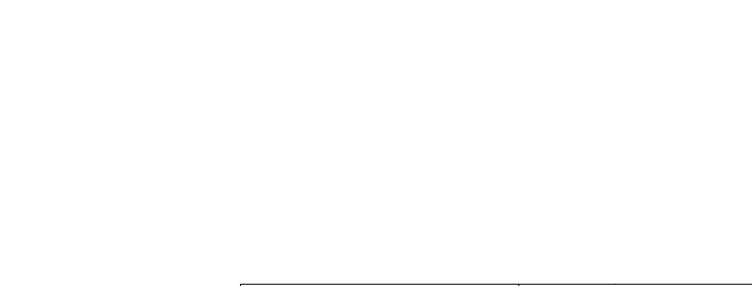
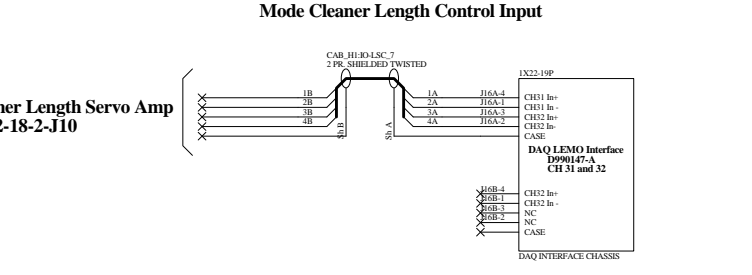
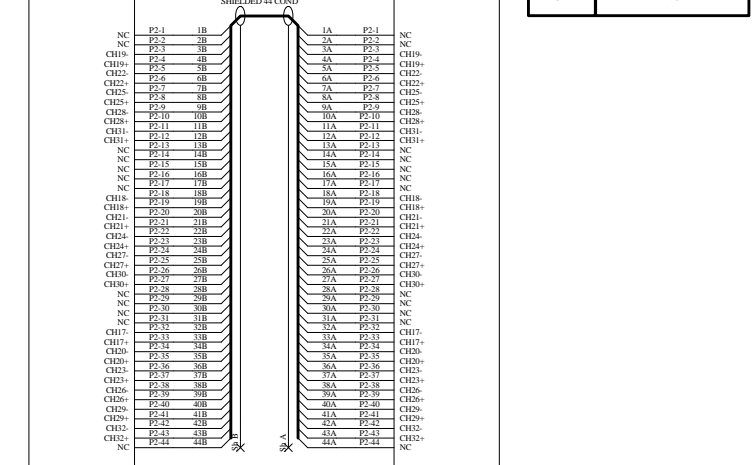

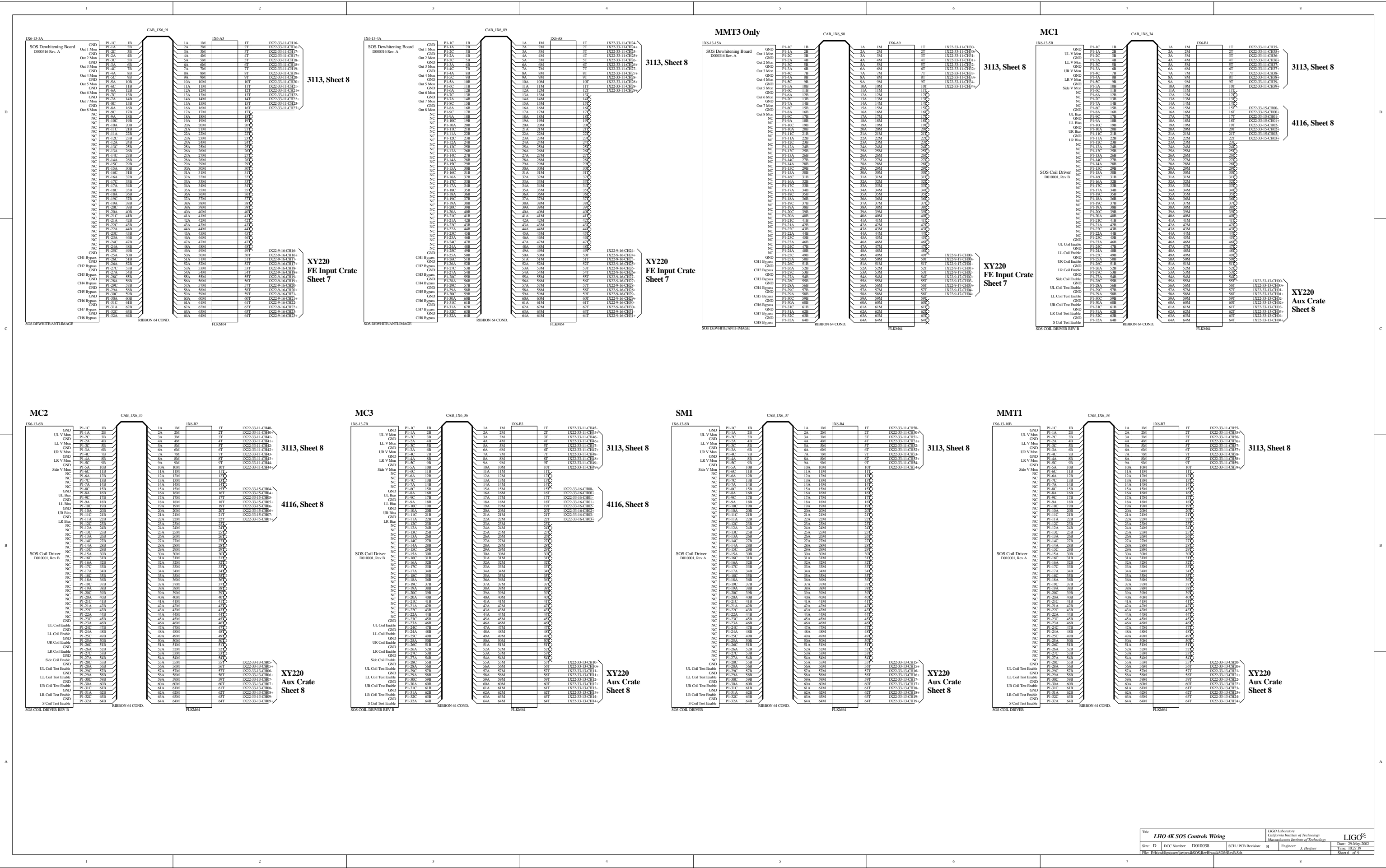

3113, Sheet 8

3113, Sheet 8

3113, Sheet 8

3113, Sheet 8

4116, Sheet 8

XY220 FE Input Crate Sheet 7

XY220 FE Input Crate Sheet 7

XY220 FE Input Crate Sheet 7

XY220 Aux Crate Sheet 8

3113, Sheet 8

3113, Sheet 8

3113, Sheet 8

3113, Sheet 8

4116, Sheet 8

4116, Sheet 8

4116, Sheet 8

4116, Sheet 8

XY220 Aux Crate Sheet 8

XY220 Aux Crate Sheet 8

XY220 Aux Crate Sheet 8

XY220 Aux Crate Sheet 8

MMT2

1X6-11.14B	CAB_1X6_39	1A	1M	1B	1T	1X22-33-11-CH00
UL V Main	PI-1C	1B	2A	3M	4T	1X22-33-11-CH00
UL V Main	PI-1A	2B	3A	4M	5T	1X22-33-11-CH00
UL V Main	PI-2A	4B	5A	6M	7T	1X22-33-11-CH00
UL V Main	PI-3C	7B	8A	9M	10T	1X22-33-11-CH00
UL V Main	PI-3A	6B	7A	8M	9T	1X22-33-11-CH00
UL V Main	PI-4C	7B	8A	9M	10T	1X22-33-11-CH00
UL V Main	PI-4A	6B	7A	8M	9T	1X22-33-11-CH00
LR V Main	PI-5C	9B	10A	11M	12T	1X22-33-11-CH00
LR V Main	PI-5A	8B	9A	10M	11T	1X22-33-11-CH00
Side V Main	PI-6C	11B	12A	13M	14T	1X22-33-11-CH00
Side V Main	PI-6A	10B	11A	12M	13T	1X22-33-11-CH00
NC	PI-7A	14B	15A	16M	17T	1X22-33-11-CH00
NC	PI-7C	15B	16A	17M	18T	1X22-33-11-CH00
NC	PI-8A	16B	17A	18M	19T	1X22-33-11-CH00
NC	PI-8C	17B	18A	19M	20T	1X22-33-11-CH00
NC	PI-9A	18B	19A	20M	21T	1X22-33-11-CH00
NC	PI-9C	19B	20A	21M	22T	1X22-33-11-CH00
NC	PI-10A	20B	21A	22M	23T	1X22-33-11-CH00
NC	PI-10C	21B	22A	23M	24T	1X22-33-11-CH00
NC	PI-11A	22B	23A	24M	25T	1X22-33-11-CH00
NC	PI-11C	23B	24A	25M	26T	1X22-33-11-CH00
NC	PI-12A	24B	25A	26M	27T	1X22-33-11-CH00
NC	PI-12C	25B	26A	27M	28T	1X22-33-11-CH00
NC	PI-13A	26B	27A	28M	29T	1X22-33-11-CH00
NC	PI-13C	27B	28A	29M	30T	1X22-33-11-CH00
NC	PI-14A	28B	29A	30M	31T	1X22-33-11-CH00
NC	PI-14C	29B	30A	31M	32T	1X22-33-11-CH00
NC	PI-15A	30B	31A	32M	33T	1X22-33-11-CH00
NC	PI-15C	31B	32A	33M	34T	1X22-33-11-CH00
NC	PI-16A	32B	33A	34M	35T	1X22-33-11-CH00
NC	PI-16C	33B	34A	35M	36T	1X22-33-11-CH00
NC	PI-17A	34B	35A	36M	37T	1X22-33-11-CH00
NC	PI-17C	35B	36A	37M	38T	1X22-33-11-CH00
NC	PI-18A	36B	37A	38M	39T	1X22-33-11-CH00
NC	PI-18C	37B	38A	39M	40T	1X22-33-11-CH00
NC	PI-19A	38B	39A	40M	41T	1X22-33-11-CH00
NC	PI-19C	39B	40A	41M	42T	1X22-33-11-CH00
NC	PI-20A	40B	41A	42M	43T	1X22-33-11-CH00
NC	PI-20C	41B	42A	43M	44T	1X22-33-11-CH00
NC	PI-21A	42B	43A	44M	45T	1X22-33-11-CH00
NC	PI-21C	43B	44A	45M	46T	1X22-33-11-CH00
NC	PI-22A	44B	45A	46M	47T	1X22-33-11-CH00
NC	PI-22C	45B	46A	47M	48T	1X22-33-11-CH00
NC	PI-23A	46B	47A	48M	49T	1X22-33-11-CH00
NC	PI-23C	47B	48A	49M	50T	1X22-33-11-CH00
NC	PI-24A	48B	49A	50M	51T	1X22-33-11-CH00
NC	PI-24C	49B	50A	51M	52T	1X22-33-11-CH00
NC	PI-25A	50B	51A	52M	53T	1X22-33-11-CH00
NC	PI-25C	51B	52A	53M	54T	1X22-33-11-CH00
NC	PI-26A	52B	53A	54M	55T	1X22-33-11-CH00
NC	PI-26C	53B	54A	55M	56T	1X22-33-11-CH00
NC	PI-27A	54B	55A	56M	57T	1X22-33-11-CH00
NC	PI-27C	55B	56A	57M	58T	1X22-33-11-CH00
NC	PI-28A	56B	57A	58M	59T	1X22-33-11-CH00
NC	PI-28C	57B	58A	59M	60T	1X22-33-11-CH00
NC	PI-29A	58B	59A	60M	61T	1X22-33-11-CH00
NC	PI-29C	59B	60A	61M	62T	1X22-33-11-CH00
NC	PI-30A	60B	61A	62M	63T	1X22-33-11-CH00
NC	PI-30C	61B	62A	63M	64T	1X22-33-11-CH00
NC	PI-31A	62B	63A	64M	65T	1X22-33-11-CH00
NC	PI-31C	63B	64A	65M	66T	1X22-33-11-CH00
NC	PI-32A	64B	65A	66M	67T	1X22-33-11-CH00
NC	PI-32C	65B	66A	67M	68T	1X22-33-11-CH00
NC	PI-33A	66B	67A	68M	69T	1X22-33-11-CH00
NC	PI-33C	67B	68A	69M	70T	1X22-33-11-CH00
NC	PI-34A	68B	69A	70M	71T	1X22-33-11-CH00
NC	PI-34C	69B	70A	71M	72T	1X22-33-11-CH00
NC	PI-35A	70B	71A	72M	73T	1X22-33-11-CH00
NC	PI-35C	71B	72A	73M	74T	1X22-33-11-CH00
NC	PI-36A	72B	73A	74M	75T	1X22-33-11-CH00
NC	PI-36C	73B	74A	75M	76T	1X22-33-11-CH00
NC	PI-37A	74B	75A	76M	77T	1X22-33-11-CH00
NC	PI-37C	75B	76A	77M	78T	1X22-33-11-CH00
NC	PI-38A	76B	77A	78M	79T	1X22-33-11-CH00
NC	PI-38C	77B	78A	79M	80T	1X22-33-11-CH00
NC	PI-39A	78B	79A	80M	81T	1X22-33-11-CH00
NC	PI-39C	79B	80A	81M	82T	1X22-33-11-CH00
NC	PI-40A	80B	81A	82M	83T	1X22-33-11-CH00
NC	PI-40C	81B	82A	83M	84T	1X22-33-11-CH00
NC	PI-41A	82B	83A	84M	85T	1X22-33-11-CH00
NC	PI-41C	83B	84A	85M	86T	1X22-33-11-CH00
NC	PI-42A	84B	85A	86M	87T	1X22-33-11-CH00
NC	PI-42C	85B	86A	87M	88T	1X22-33-11-CH00
NC	PI-43A	86B	87A	88M	89T	1X22-33-11-CH00
NC	PI-43C	87B	88A	89M	90T	1X22-33-11-CH00
NC	PI-44A	88B	89A	90M	91T	1X22-33-11-CH00
NC	PI-44C	89B	90A	91M	92T	1X22-33-11-CH00
NC	PI-45A	90B	91A	92M	93T	1X22-33-11-CH00
NC	PI-45C	91B	92A	93M	94T	1X22-33-11-CH00
NC	PI-46A	92B	93A	94M	95T	1X22-33-11-CH00
NC	PI-46C	93B	94A	95M	96T	1X22-33-11-CH00
NC	PI-47A	94B	95A	96M	97T	1X22-33-11-CH00
NC	PI-47C	95B	96A	97M	98T	1X22-33-11-CH00
NC	PI-48A	96B	97A	98M	99T	1X22-33-11-CH00
NC	PI-48C	97B	98A	99M	100T	1X22-33-11-CH00
NC	PI-49A	98B	99A	100M	101T	1X22-33-11-CH00
NC	PI-49C	99B	100A	101M	102T	1X22-33-11-CH00
NC	PI-50A	100B	101A	102M	103T	1X22-33-11-CH00
NC	PI-50C	101B	102A	103M	104T	1X22-33-11-CH00
NC	PI-51A	102B	103A	104M	105T	1X22-33-11-CH00
NC	PI-51C	103B	104A	105M	106T	1X22-33-11-CH00
NC	PI-52A	104B	105A	106M	107T	1X22-33-11-CH00
NC	PI-52C	105B	106A	107M	108T	1X22-33-11-CH00
NC	PI-53A	106B	107A	108M	109T	1X22-33-11-CH00
NC	PI-53C	107B	108A	109M	110T	1X22-33-11-CH00
NC	PI-54A	108B	109A	110M	111T	1X22-33-11-CH00
NC	PI-54C	109B	110A	111M	112T	1X22-33-11-CH00
NC	PI-55A	110B	111A	112M	113T	1X22-33-11-CH00
NC	PI-55C	111B	112A	113M	114T	1X22-33-11-CH00
NC	PI-56A	112B	113A	114M	115T	1X22-33-11-CH00
NC	PI-56C	113B	114A	115M	116T	1X22-33-11-CH00
NC	PI-57A	114B	115A	116M	117T	1X22-33-11-CH00
NC	PI-57C	115B	116A	117M	118T	1X22-33-11-CH00
NC	PI-58A	116B	117A	118M	119T	1X22-33-11-CH00
NC	PI-58C	117B	118A	119M	120T	1X22-33-11-CH00
NC	PI-59A	118B	119A	120M	121T	1X22-33-11-CH00
NC	PI-59C	119B	120A	121M	122T	1X22-33-11-CH00
NC	PI-60A	120B	121A	122M	123T	1X22-33-11-CH00
NC	PI-60C	121B	122A	123M	124T	1X22-33-11-CH00
NC	PI-61A	122B	123A	124M	125T	1X22-33-11-CH00
NC	PI-61C	123B	124A	125M	126T	1X22-33-11-CH00
NC	PI-62A	124B	125A	126M	127T	1X22-33-11-CH00
NC	PI-62C	125B	126A	127M	128T	1X22-33-11-CH00
NC	PI-63A	126B	127A	128M	129T	1X22-33-11-CH00
NC	PI-63C	127B	128A	129M	130T	1X22-33-11-CH00
NC	PI-64A	128B	129A	130M	131T	1X22-33-11-CH00
NC	PI-64C	129B	130A	131M	132T	1X22-33-11-CH00
NC	PI-65A	130B	131A	132M	133T	1X22-33-11-CH00
NC	PI-65C	131B	132A	133M	134T	1X22-33-11-CH00
NC	PI-66A	132B	133A	134M	135T	1X22-33-11-CH00
NC	PI-66C	133B	134A	135M	136T	1X22-33-11-CH00
NC	PI-67A	134B	135A	136M	137T	1X22-33-11-CH00
NC	PI-67C	135B	136A	137M	138T	1X22-33-11-CH00
NC	PI-68A	136B	137A	138M	139T	1X22-33-11-CH00
NC	PI-68C	137B	138A	139M	140T	1X22-33-11-CH00
NC	PI-69A	138B	139A	140M	141T	1X22-33-11-CH00
NC	PI-69C	139B	140A	141M	142T	1X22-33-11-CH00
NC	PI-70A	140B	141A	142M	143T	1X22-33-11-CH00
NC	PI-70C	141B	142A	143M	144T	1X22-33-11-CH00
NC	PI-71A	142B	143A	144M	145T	1X22-33-11-CH00
NC	PI-71C	143B	144A	145M	146T	1X22-33-11-CH00
NC	PI-72A	144B	145A	146M	147T	1X22-33-11-CH00
NC	PI-72C	145B	146A	147M	148T	1X22-33-11-CH00
NC	PI-73A	146B	147A	148M	149T	1X22-33-11-CH00
NC	PI-73C	147B	148A	149M	150T	1X22-33-11-CH00
NC	PI-74A	148B	149A	150M	151T	1X22-33-11-CH00
NC	PI-74C	149B	150A	151M	152T	1X22-33-11-CH00
NC	PI-75A	150B	151A	152M	153T	1X22-33-11-CH00
NC	PI-75C	151B	152A	153M	154T	1X22-33-11-CH00
NC	PI-76A	152B	153A	154M	155T	1X22-33-11-CH00
NC	PI-76C	153B	154A	155M	156T	1X22-33-11-CH00
NC	PI-77A	154B	155A	156M	157T	1X22-33-11-CH00
NC	PI-77C	155B	156A	157M	158T	1X22-33-11-CH00
NC	PI-78A	156B	157A	158M	159T	1X22-33-11-CH00
NC	PI-78C	157B	158A	159M	160T	1X22-33-11-CH00
NC	PI-79A	158B	159A	160M	161T	1X22-33-11-CH00
NC	PI-79C	159B	160A	161M	162T	1X22-33-11-CH00
NC	PI-80A	160B	161A	162M	163T	1X22-33-11-CH00
NC	PI-80C	161B	162A	163M	164T	1X22-33-11-CH00
NC	PI-81A	162B	163A	164M	165T	1X22-33-11-CH00
NC	PI-81C	163B	164A	165M	166T	1X22-33-11-CH00
NC	PI-82A	164B	165A	166M	167T	1X22-33-11-CH00
NC	PI-82C	165B	166A	167M	168T	1X22-33-11-CH00
NC	PI-83A	166B	167A	168M	169T	1X22-33-11-CH00
NC	PI-83C	167B	168A	169M	170T	1X22-33-11-CH00
NC	PI-84A	168B	169A	170M	171T	1X22-33-11-CH00
NC	PI-84C	169B				

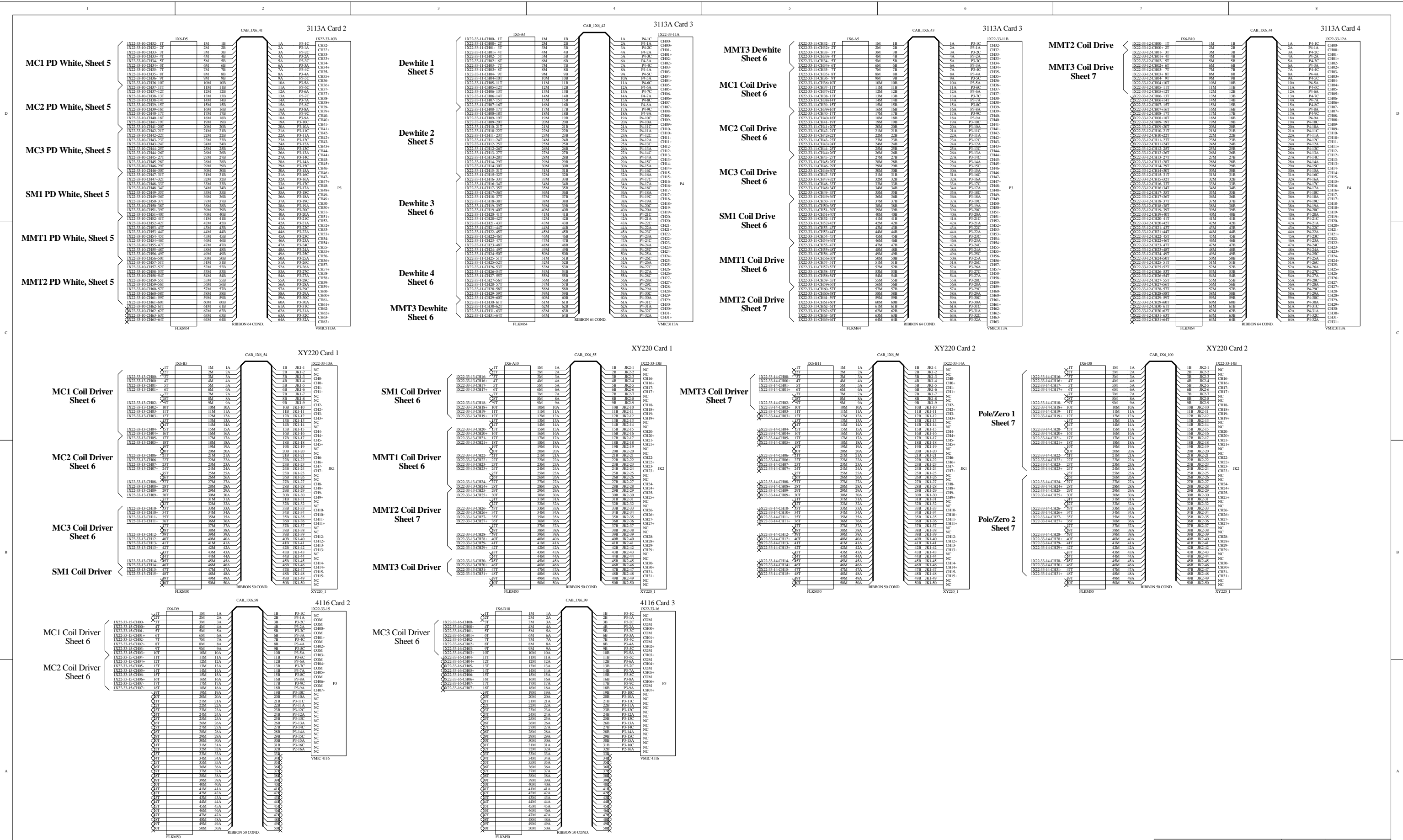

MC1 PD White, Sheet 5

MC2 PD White, Sheet 5

MC3 PD White, Sheet 5

SM1 PD White, Sheet 5

MMT1 PD White, Sheet 5

MMT2 PD White, Sheet 5

Dewhite 1 Sheet 5

Dewhite 2 Sheet 5

Dewhite 3 Sheet 6

Dewhite 4 Sheet 6

MMT3 Dewhite Sheet 6

MMT3 Dewhite Sheet 6

MC1 Coil Drive Sheet 6

MC2 Coil Drive Sheet 6

MC3 Coil Drive Sheet 6

SM1 Coil Drive Sheet 6

MMT1 Coil Drive Sheet 6

MMT2 Coil Drive Sheet 7

MMT2 Coil Drive Sheet 7

MMT3 Coil Drive Sheet 7

MC1 Coil Driver Sheet 6

MC2 Coil Driver Sheet 6

MC3 Coil Driver Sheet 6

SM1 Coil Driver Sheet 6

SM1 Coil Driver Sheet 6

MMT1 Coil Driver Sheet 6

MMT2 Coil Driver Sheet 7

MMT3 Coil Driver Sheet 6

MMT3 Coil Driver Sheet 7

Pole/Zero 1 Sheet 7

Pole/Zero 2 Sheet 7

MC1 Coil Driver Sheet 6

MC2 Coil Driver Sheet 6

MC3 Coil Driver Sheet 6

Eurocard Crate Power Connections for Crate 1X20-5

Note:
Power Connections for Eurocard modules are made through the backplane and are designated as VX6-2-BP1. Bulk power supply connections to the eurocard backplane lugs are designated V in Rack 1X6-2.

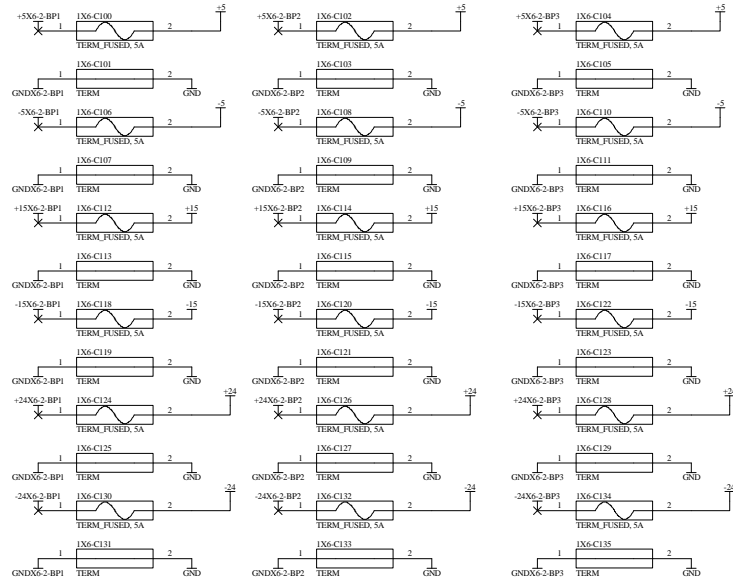

Eurocard Crate Power Connections for Crate 1X20-22

Note:
Power Connections for Eurocard modules are made through the backplane and are designated as VX6-13-BP1. Bulk power supply connections to the eurocard backplane lugs are designated V in Rack 1X6-13.

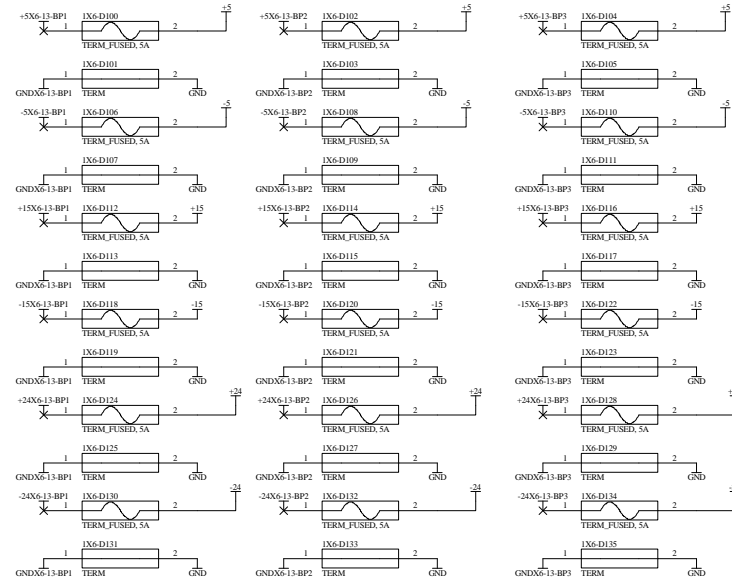

Rev	Description of Change	Date
00	Preliminary Fab Release	2/01
01	Move MMT3 outputs to SOS FE crate 1. Change cables CAB_1X7_23 to 1X7_27 to 1X6_93 to 1X6_97	4/01
02	As built changes to FE XY220 wiring on sheet 7. H/W channels made to match software.	5/01
03	1. Added Pole/Zero modules to MC mirror paths. 2. Changed MC coil drivers to Rev B model. 3. Added XY220 and 4116 channels for Pole/zero and Rev B coil driver additional controls.	2/02
A	Initial Release: Changes to MMT3 Dewhite Enable connections to FE XY220, Sheet 6 and 7 to match software	3/02
B	Changes to MMT3 Dewhite Enable connections to FE XY220, Sheet 6 and 7 to match software	6/02

1

2

3

4

5

6

wa4kSOS1RevB
wa4kSOS1RevB.Sch



wa4kSOS2RevB
wa4kSOS2RevB.Sch



wa4kSOS3RevB
wa4kSOS3RevB.Sch



wa4kSOS4RevB
wa4kSOS4RevB.Sch



wa4kSOS5RevB
wa4kSOS5RevB.Sch



wa4kSOS6RevB
wa4kSOS6RevB.Sch



wa4kSOS7RevB
wa4kSOS7RevB.Sch



wa4kSOS8RevB
wa4kSOS8RevB.Sch



wa4kSOS9RevB
wa4kSOS9RevB.Sch



D

D

C

C

B

B

A

A

Title		<i>LHO 4K SOS Controls Wiring</i>		LIGO Laboratory California Institute of Technology Massachusetts Institute of Technology		LIGO	
Size: B	DCC Number: D010038	SCH / PCB Revision: B	Engineer: J. Heefner	Date: 29-May-2002	Time: 10:26:17		
File: E:\hcad\ligo\users\jay\wa4kSOS\RevB\wa4kSOSRevB.Prj				Sheet 0 of 9			

1

2

3

4

5

6