

HAM ISI Test Stand

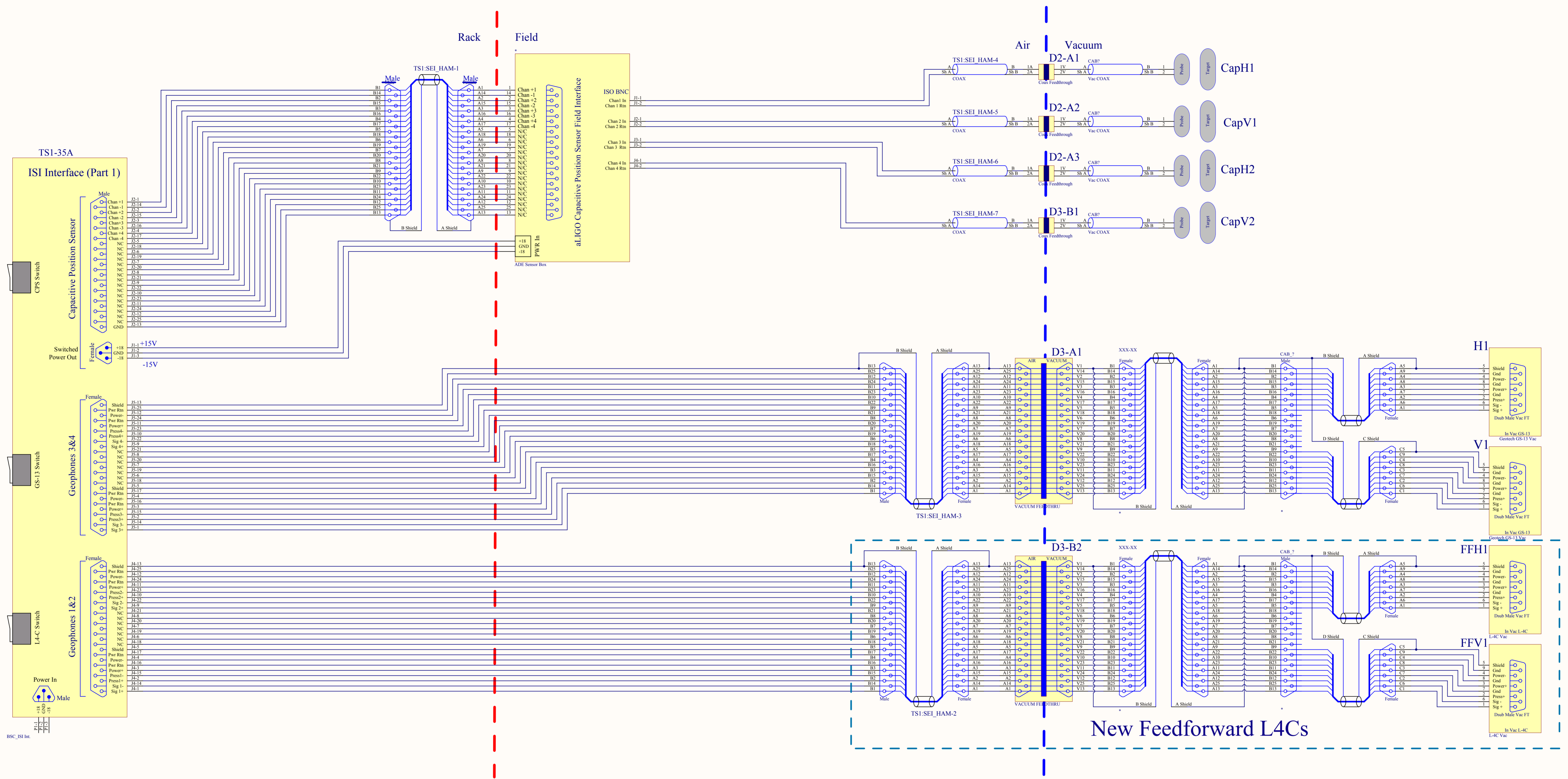

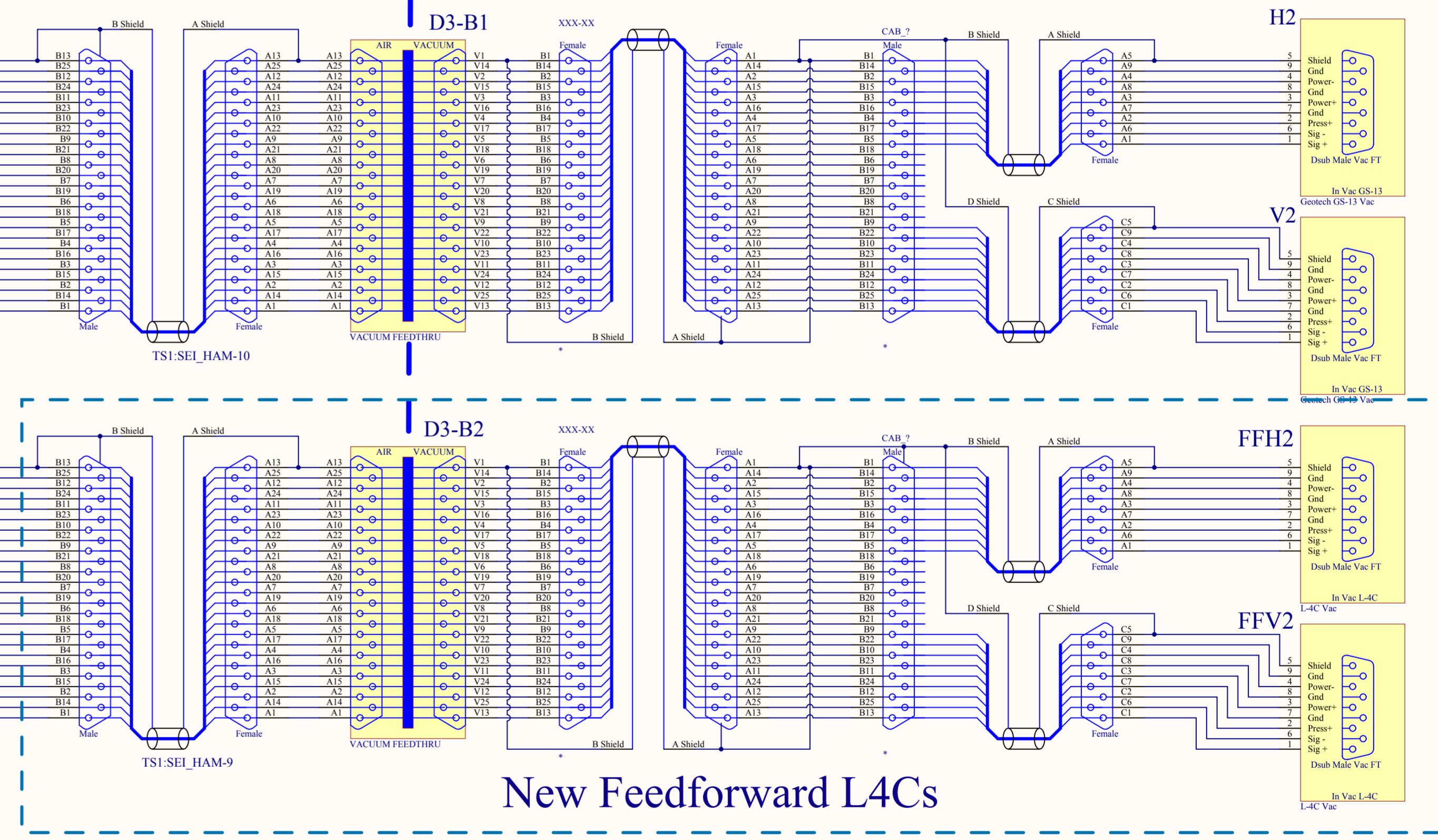

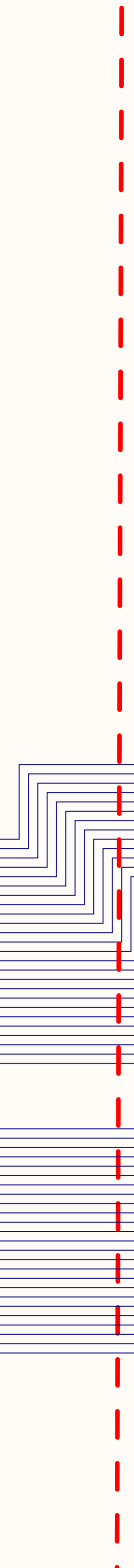
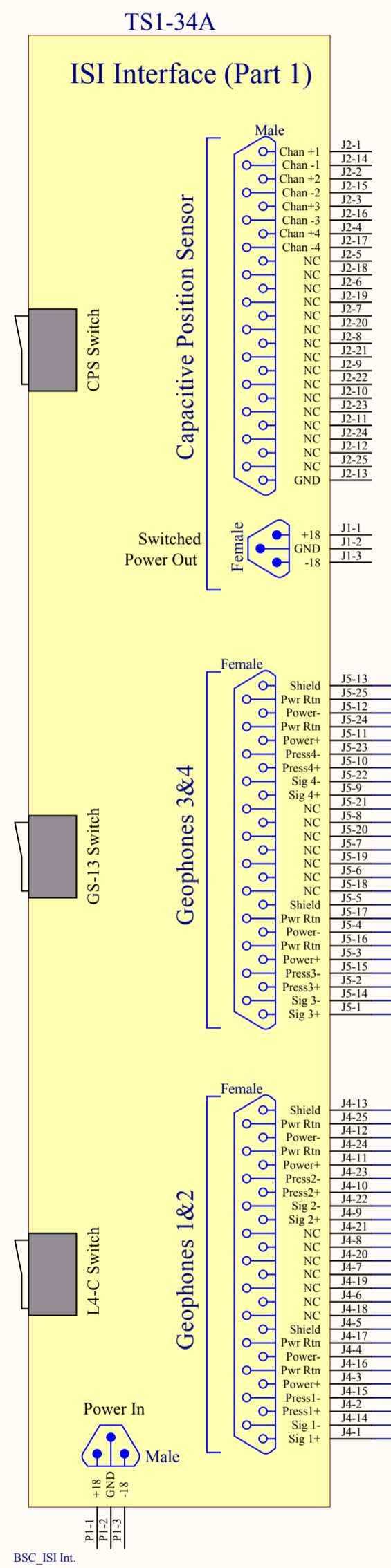
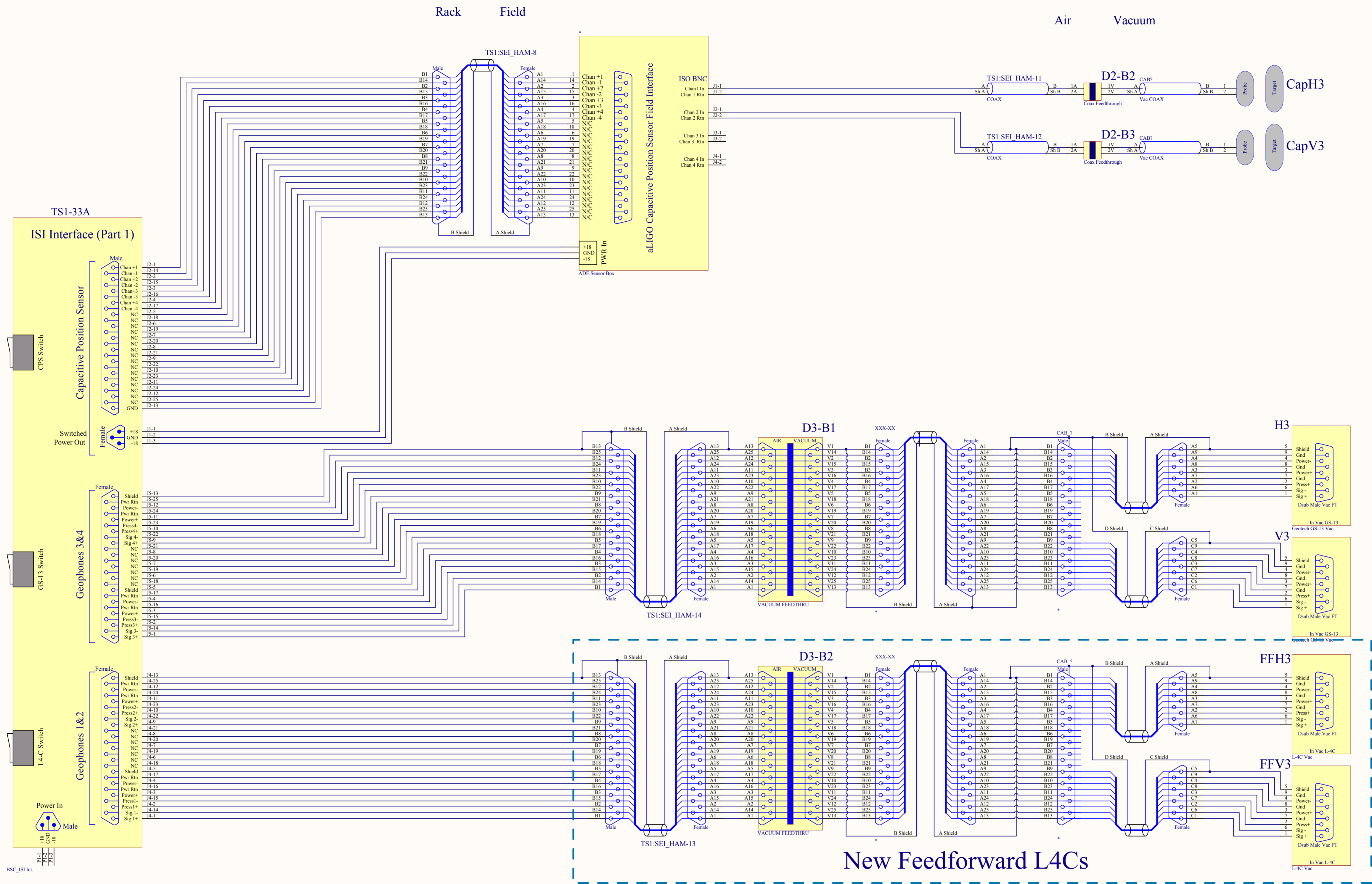

New Feedforward L4Cs

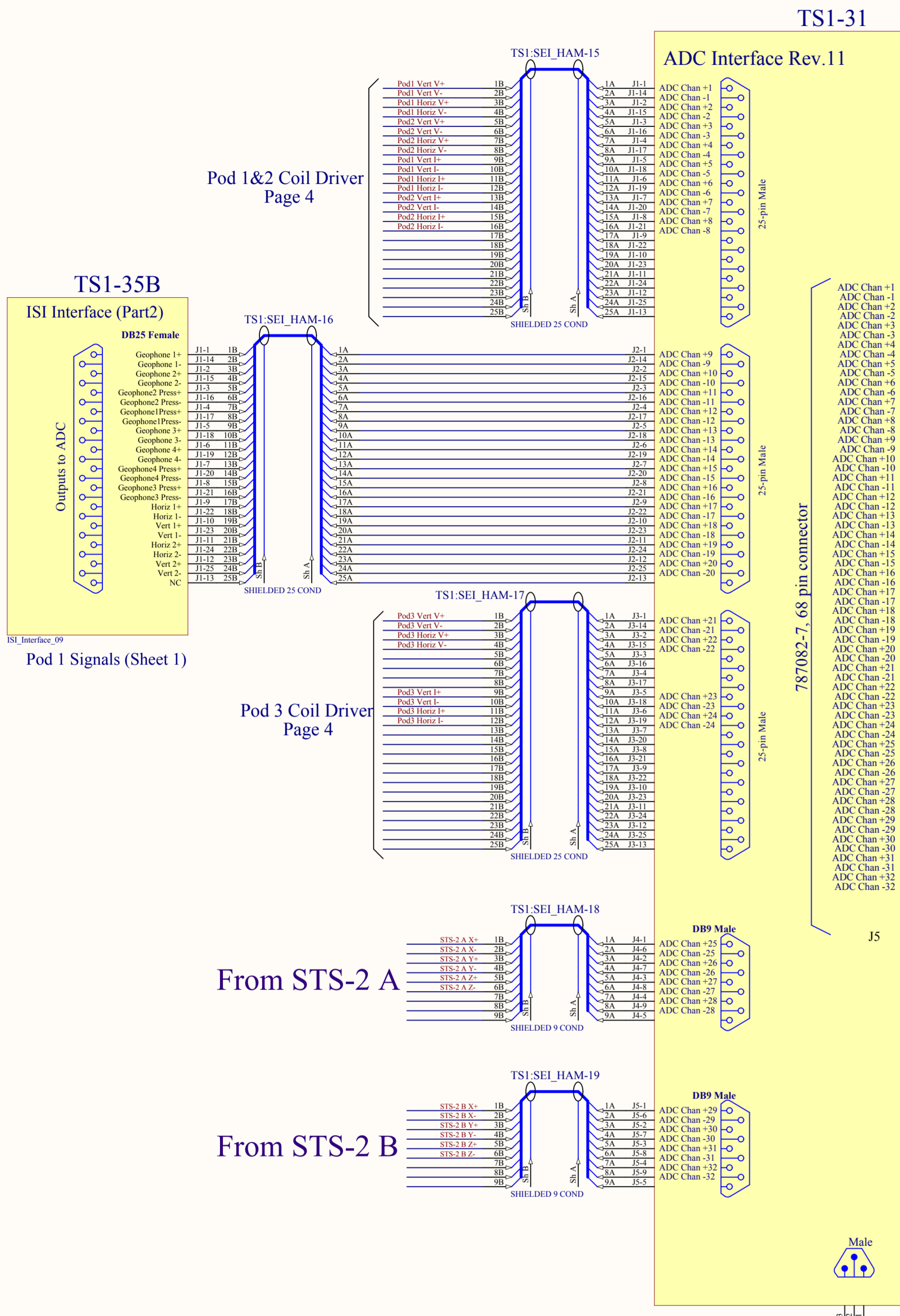

TSI-11-1

General Standards ADC IO Chassis Slot 1

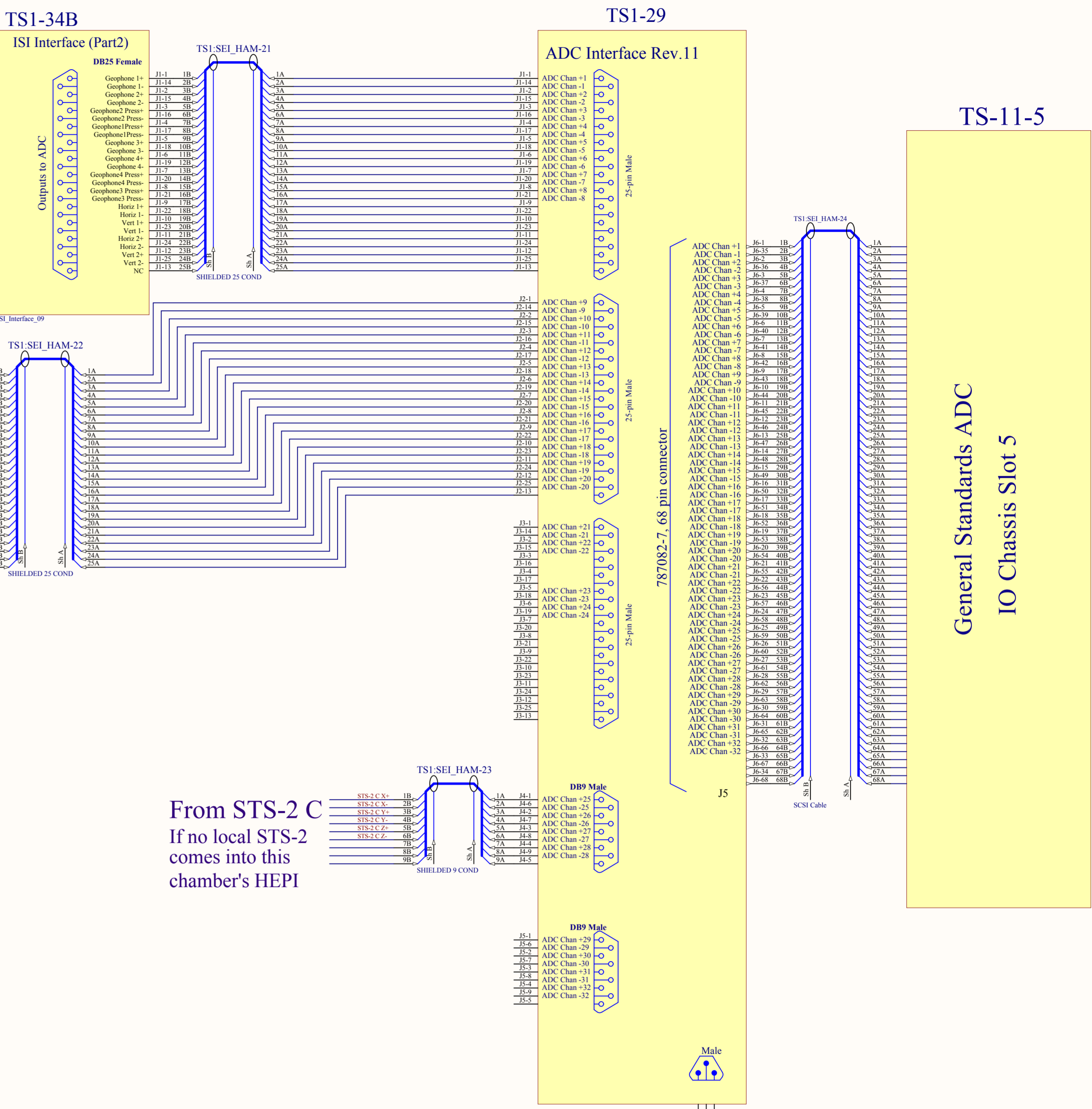
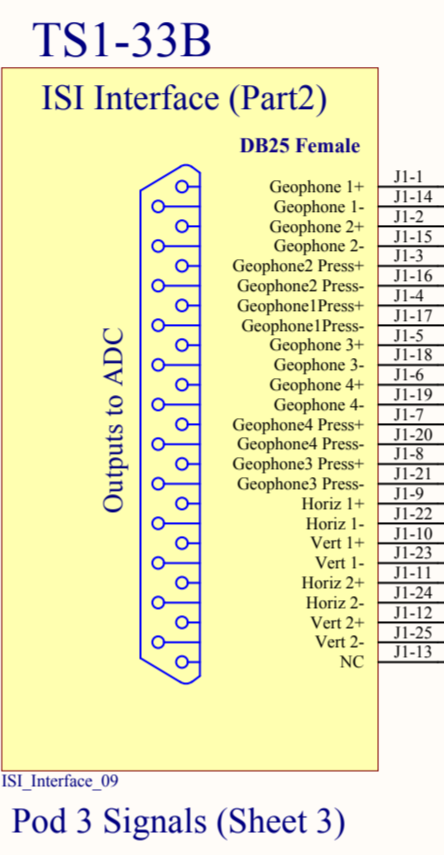

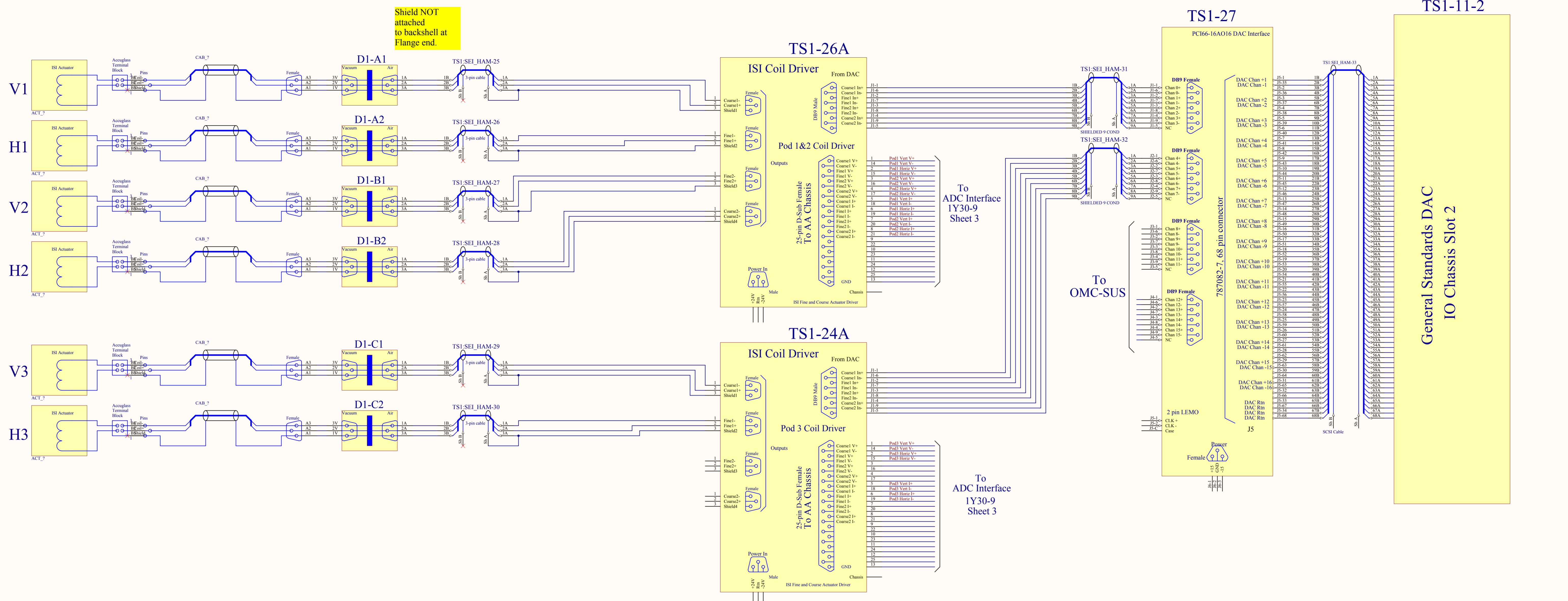

Test Stand 1

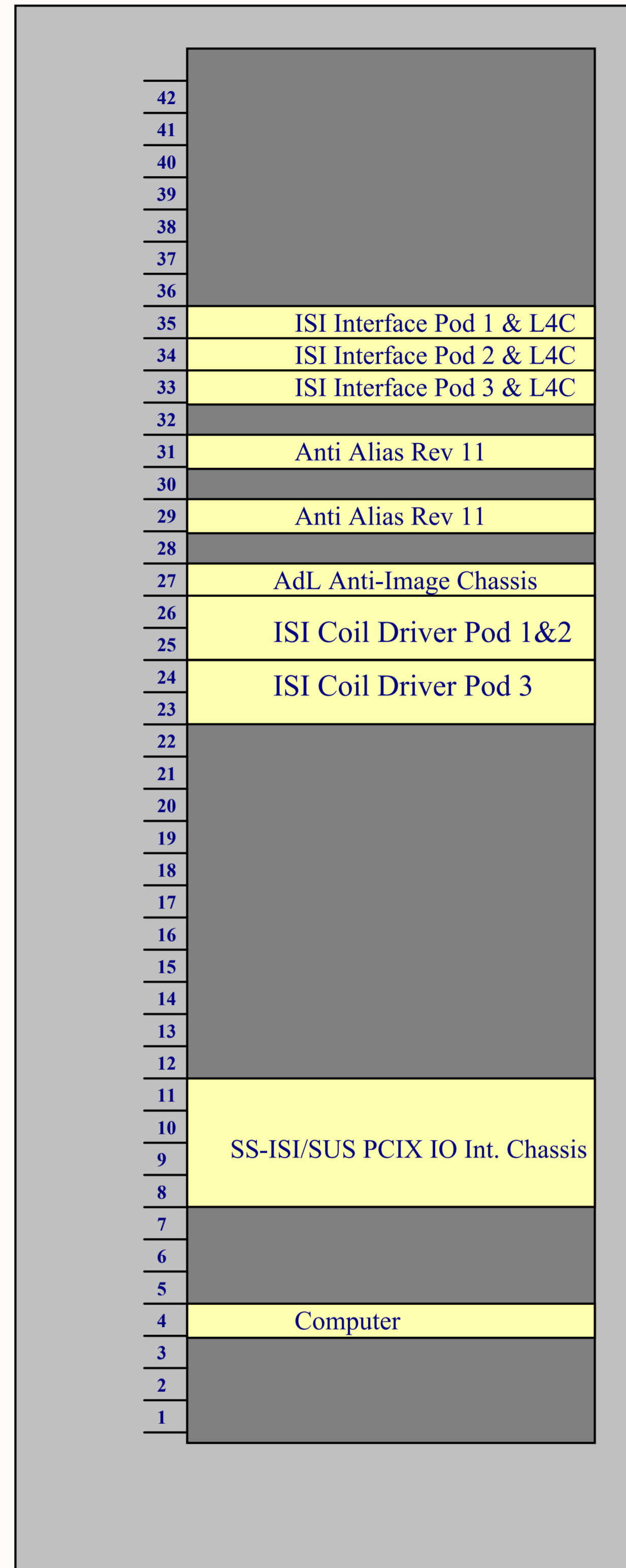

Title <i>HAM ISI Test Stand System Wiring</i>			
Size: B	DCC Number: D1001412		<i>Ligo Project</i> <i>California Institute of Technology</i> <i>Massachusetts Institute of Technology</i> 
Drawn by: Ben Abbott	Date: 7/13/2010	Revision: v4	
File: C:\Ben\Seismic\ISI\Single Stage ISI\TestStands\AdLSEI_Single_Stage\T1\TechDraw\02:22 AM\Sheet 6 of 6			