



LIGO Laboratory / LIGO Scientific Collaboration

LIGO-T1000230-v6

LIGO

1 Feb 2011

Auxiliary Optics System (AOS)
Initial Alignment System (IAS)
Final Design Document

Doug Cook, Dennis Coyne, Eric Gustafson, Eric James, Scott Shankle

Distribution of this document:
LIGO Scientific Collaboration

This is an internal working note
of the LIGO Laboratory.

California Institute of Technology
LIGO Project – MS 18-34
1200 E. California Blvd.
Pasadena, CA 91125
Phone (626) 395-2129
Fax (626) 304-9834
E-mail: info@ligo.caltech.edu

Massachusetts Institute of Technology
LIGO Project – NW22-295
185 Albany St
Cambridge, MA 02139
Phone (617) 253-4824
Fax (617) 253-7014
E-mail: info@ligo.mit.edu

LIGO Hanford Observatory
P.O. Box 159
Richland WA 99352
Phone 509-372-8106
Fax 509-372-8137

LIGO Livingston Observatory
P.O. Box 940
Livingston, LA 70754
Phone 225-686-3100
Fax 225-686-7189

<http://www.ligo.caltech.edu/>

Table of Contents

1	<i>Purpose</i>	6
2	<i>Scope</i>	6
3	<i>Terminology</i>	6
4	<i>Overview</i>	7
5	<i>Requirements</i>	8
6	<i>Alignment References</i>	9
6.1	X and Y	9
6.2	Z	13
7	<i>Comparison to Initial LIGO</i>	15
8	<i>Equipment</i>	16
8.1	Optical Level	17
8.2	Optical Transit Square	17
8.3	Total Station	18
8.4	Electronic Visible Laser Autocollimator	19
8.5	Infrared Laser Autocollimator	20
8.6	Coordinate Measuring Machine (CMM)	21
8.7	Lateral Transfer Retroreflectors	21
9	<i>Characteristics of the Primary Optics</i>	22
9.1	Optical Layout	22
9.2	Locations and Orientations	22
9.3	Optical coating reflectance and transmission	23
9.4	Chromatic error	30
10	<i>Basic Alignment Sequence</i>	31
10.1	HAM Chamber Payloads	31
10.1.1	Establish the Optical Alignment Axis	33
10.1.2	Optics Table Alignment.....	33
10.1.3	Approximate Alignment with Templates	35
10.1.4	Precise Alignment.....	36
10.2	BSC Chamber Payloads	39
10.2.1	Test Mass Alignment within the quadruple pendulum assembly	40
10.2.2	Establish an Offset Optical Alignment Axis for the Test Stand.....	41
10.2.3	Optics Table Alignment on the Test Stand.....	42
10.2.4	Approximate Template Alignment	43
10.2.5	Co-Alignment of the Cartridge Assembly Elements	43

10.2.6	Establish an Offset Optical Alignment Axis for the Chamber	47
10.2.7	Align the Cartridge within the Chamber.....	48
11	<i>Alignment Check</i>	49
12	<i>Alignment Sequence</i>	50
12.1	Alignment Sequence Constraints	50
12.2	Planned Sequence	52
13	<i>Other alignment notes</i>	53
13.1	Reflective Targets	53
13.2	Temporary Recycling Cavity Septum Plates	53
14	<i>Safety</i>	53
15	<i>Cleanliness</i>	53
16	<i>Interface Requirements</i>	53
17	<i>Alignment Error Budget</i>	54
17.1	Yaw	54
17.2	Pitch	54
18	<i>Final Design Review Checklist</i>	55
19	<i>References</i>	57

List of Figures

<i>Figure 1: Basic Monument Reference Approach for LLO</i>	11
<i>Figure 2: Basic Monument Reference Approach for LHO</i>	12
<i>Figure 3 LHO Elevation Reference Scribe Mark Designations</i>	14
<i>Figure 4 LLO Elevation Reference Scribe Mark Designations</i>	15
<i>Figure 5 Precision Optical Level</i>	17
<i>Figure 6 Brunson Optical Transit Square (model 75-H)</i>	18
<i>Figure 7 Total Stations to be used for aLIGO</i>	19
<i>Figure 8 Visible Laser Autocollimator mounted on the Total Station Gimbal</i>	20
<i>Figure 9 CMMs for aLIGO</i>	21
<i>Figure 10 Use of a lateral transfer retroreflectors</i>	22
<i>Figure 11: ITM HR Transmittance vs wavelength (design)</i>	25
<i>Figure 12: ETM HR Reflectance vs Wavelength (design)</i>	26
<i>Figure 13: PR2 and F-PR2 HR Reflectance Spectra</i>	27
<i>Figure 14: PRM & F-PRM HR Reflectance Spectra</i>	28
<i>Figure 15: SRM & F-SRM HR Reflectance Spectra</i>	28
<i>Figure 16: SR2 & F-SR2 Reflectance Spectra</i>	29
<i>Figure 17: BS, FM, PR3 and SR3 Reflectance vs Wavelength (design)</i>	30
<i>Figure 18 Establishing the Optical Alignment Axis for the input HAM-ISI tables</i>	33
<i>Figure 19 Setting the HAM Optics Table Height and Level</i>	34
<i>Figure 20 Setting the HAM Optics Table Yaw and Position within a Horizontal Plane (WHAM5 chamber assembly is shown as an example.)</i>	35
<i>Figure 21 Example use of an Alignment Template (approximate alignment of the SR3, SRM and OFI in HAM5)</i>	36
<i>Figure 22 Retroreflector Mounted to a HSTS</i>	38
<i>Figure 23 Suspension Frame Alignment Adjustment</i>	39
<i>Figure 24 Determining the optical alignment references for the Mechanical Test Stand</i>	42
<i>Figure 25 Checking the BSC Optics Table Height</i>	43
<i>Figure 26 Retroreflector mounted to a ITM Suspension</i>	44
<i>Figure 27 Pusher used to adjust the quad suspension position at LASTI</i>	45
<i>Figure 28 Alignment of the FM on the Test Stand</i>	46
<i>Figure 29 Alignment of the FM chamber beam dumps</i>	46
<i>Figure 30 Alignment of the TMS</i>	47
<i>Figure 31 Establishing the Optical Alignment Axis for HI ITMx</i>	48
<i>Figure 32 Setting the BSC Optics Table Height and Level in the Chamber</i>	49
<i>Figure 33 Alignment check of the PRC Optics</i>	50
<i>Figure 34: Possible interferences with IAS Lines Of-Sight</i>	51

List of Tables

<i>Table 1 Elevation Scribe Positions (in meters)</i>	14
<i>Table 2 Global Direction Cosines (microradians)</i>	23
<i>Table 3: Reflectance of Primary Optic Surfaces (at 670 nm and 840 nm)</i>	24
<i>Table 4 Chromatic Error</i>	31
<i>Table 5 Alignment Parameters</i>	32
<i>Table 7 Currently Planned Installation and Alignment Sequence</i>	52
<i>Table 8 Total Yaw Angular Error Accumulation</i>	54
<i>Table 9 Total Pitch Angular Error Accumulation</i>	55

1 Purpose

The final design for the Initial Alignment System (IAS) is described in this document. IAS is a component of the Auxiliary Optics System (AOS) for Advanced LIGO (aLIGO). The Initial Alignment System (IAS) comprises the necessary equipment and procedures for setting the initial positions and the angular alignments of all suspended optics, optic tables and for establishing the input laser beam propagation.

2 Scope

The principal scope of the IAS system is to align the primary optics of the aLIGO system (see terminology in section 3). This task includes preliminary alignment support for optical payloads as they are integrated onto the seismically isolated tables. It also includes alignment of beam dumps and baffles associated with the primary optics.

In addition to this principal role, IAS is responsible for enabling alignment of all other optical systems to the primary optics. This task involves providing targets or pre-aligned optics which allows the non-primary optics to be aligned to the primary optics.

All tooling, alignment instruments and alignment procedures are the responsibility of the IAS subsystem. All alignment activities are performed under the direction of the Installation team.

The following alignment tasks are not part of the IAS scope:

- 1) Pre-Stabilized Laser (PSL) alignment: The PSL group is responsible for alignment of its optical elements and for optical alignment to its interface with the Input Optics (IO) group.
- 2) Input Optics (IO) alignment: The IO subsystem defines their alignment procedures and tooling to enable the IO elements to direct the PSL beam into the Mode Cleaner and to deliver the beam from the Mode Cleaner to the power recycling cavity.
- 3) IO optics table alignment: The IO group is responsible for alignment to, and within, its diagnostic beam optics table(s).
- 4) Interferometer Sensing and Control (ISC) alignment: The ISC subsystem has optical elements and detectors within the HAM1 and HAM6 chambers (HAM7 and HAM12 for the H2 interferometer), the Transmission Monitor (TransMon) and the Arm Length Stabilization (ALS) systems. The procedures and tooling for alignment of these optical elements are ISC's responsibility.
- 5) Optical Levers (OptLev): Optical levers monitor the core optics and the optical tables of HAM chambers 2, 3, 4 and 5 (8, 9, 10 and 11 for H2). The procedures and tooling for the alignment of the optical levers are the responsibility of the OptLev group.
- 6) Thermal Compensation System (TCS) Laser: the procedures and tooling for the alignment of the CO2 laser used for the TCS system is a TCS responsibility.
- 7) Hartmann Wavefront Sensor (HWS): the procedures and tooling for the alignment of the CO2 laser used for the TCS system is a TCS responsibility.

3 Terminology

Alignment refers to both positional and angular alignment

Core Optic a subset of the "primary optics" that are the responsibility of the Core Optics subsystem, generally those optics which are both large and have

demanding performance requirements. The core optics are the primary optics less the PR2, PRM, SR2 and SRM.

Derived Monument	Monuments which are created by extension from, or reference to, the primary monuments. Many derived monuments (or marks) were created during the initial alignment of initial LIGO, but the documentation is only in personal note form. These monuments will only be used if there is high confidence in their position. Primary monuments are the preferred alignment references.
Primary Monuments	We define the primary monuments as those defined in: D970210 , ASC Monument Locations – Washington Site D980499 , ASC Equipment Locations – Louisiana Site They are comprised of monuments designated IAM and PSI.
Primary Optics	those optics which form the basic interferometer configuration (a dual recycled, Michelson interferometer with Fabry-Pérot arm cavities). All other optics, as well as the laser beams injected into the system, are aligned to the primary optics. The primary optics consists of the following: ETMs, ITMs, BS, FM, PR3, PR2, PRM, SR3, SR2 and SRM.

4 Overview

The aLIGO IAS design combines the elements of the iLIGO IAS design, as described in the final design document [T980019-00](#), ASC Initial Alignment Subsystem Final Design; and the IR autocollimator alignment techniques described in [T980072-01](#), COS IR Autocollimator Alignment System and [T000065-05](#), COS 4K IFO Alignment Procedure making necessary or recommended changes to adopt to the aLIGO requirements.

The alignment can be viewed as occurring in four basic steps:

- 1) Sub-Assembly Alignment: Co-align optical elements to one another within an assembly (e.g. the telescope and optical train of the Transmission Monitor). This is generally the responsibility of each subsystem; The one exception is alignment of the test mass optics (ETM and ITM) within the quadruple suspension when the fiber suspension is welded to the mating horns of the ear which is bonded to each test mass optic. IAS defines within this document the alignment approach for this monolithic suspension assembly.
- 2) Cartridge Alignment: Co-align major payload elements sharing the same BSC optics table as an assembly before installation into the BSC chamber (this is not possible for HAM chamber payload elements). This is known as the “cartridge assembly”.
- 3) In Situ, Individual Assembly Alignment: Align optical elements in situ. For BSC chambers, this means moving the cartridge assembly as a rigid body, using HEPI as the actuator. For HAM chambers this means aligning each individual assembly on a HAM optics table.
- 4) Relative Alignment/Check: Once the optical elements have each been aligned to their theoretically ideal positions/orientations based on survey monuments, we check, and adjust, so that the optics are aligned properly relative to one another. In this case the optical reference is not derived from the survey monuments, but from the test mass high reflectance (HR) face(s).

Ideally we would proceed sequentially through each of these steps. In addition it is best to install the test mass optics first and thereby establish the best references (short of having the long arms open) for co-aligning all other primary optics. However we need to support an installation sequence which may not be optimal for initial alignment but allows for commissioning of subsets of the full interferometer (e.g. H2 Y long arm test, L1 mode cleaner test, L1 near Michelson test, etc.). For the planned L1 interferometer installation, we need to accommodate installation of the input optics section first and then be able to match the input optics to the balance of the near Michelson optics and the arm cavities. In addition, if problems arise during the installation it may be necessary to accommodate changes in the alignment sequence. So we need an alignment approach which is flexible and can accommodate piecemeal installation in a sequence which may not be optimal.

Rather than start by describing the exact sequence of alignment steps which are consistent with the current installation schedules, we will first describe the ideal sequence of alignment steps. In the next section the alignment sequence is described separately for the HAM chamber optical payloads and for the BSC chamber optical payloads. Then a description of the relative (or co-alignment) check is given. Finally a description of the alignment is given for the likely/planned installation sequence. We give reference to detailed flow charts which describe how the initial alignment accommodates the installation sequence constraints.

The IAS will position and angularly orient the primary optics and associated optical elements (beam dumps, baffles, etc.) by reference to the alignment survey monuments within the corner and end station buildings (as was done for initial LIGO). Standard optical surveying equipment (e.g. a total station theodolite, optical square) is used to derive/transfer the optical axes for the equipment to be aligned. Laser autocollimators are used to orient the reflective surfaces of optics to the desired optical axis. Electronic distance measurement (EDM with a total station capability) is used with optical retroreflectors to set the longitudinal position. The lateral position is set with the theodolite using a target with crosshairs placed on the optical element to be positioned.

5 Requirements

The IAS design is consistent with the requirements defined in [T080307](#). The requirements are similar to those for initial LIGO, but with tighter positional tolerances on the recycling cavity optics. Since the initial LIGO alignment was successful, there is little risk for advanced LIGO IAS.

The basic alignment requirements are:

- Axial positioning to within ± 3 mm
- Transverse positioning to within ± 1 mm for the ITMs and ETMs,
- Transverse positioning to within ± 1 mm vertically and ± 2 mm horizontally for the PRM, PR2, SRM and SR2,
- Transverse positioning to within ± 3 mm for the BS, FM, PR3 and SR3 optics.
- Angular pointing to within 10% of the actuator dynamic range, which corresponds to $\pm \sim 100$ microradians generally.

The transverse positioning accuracies called out above are relative to the common beam line (chief ray of the 1064 main beam path). Since the alignment reference monuments have a positional accuracy of ± 3 mm we must take care to use common references (see section 6.1).

6 Alignment References

Although many of the original monuments are brass plugs in the floor, many of the added monuments are scribe or punch marks in the cement floor. In order to achieve the accuracy needed in the aLIGO survey better, more permanent, means of creating precise monument references (marks) on the floor are required. We wish to avoid drilling and cementing into the concrete floor. We have in mind epoxying brass markers to the floor. The precise details are TBD.

While we will retain the monuments created to date, including their numbering/naming, we wish to standardize all monuments by creating a database of monument coordinates in an excel spreadsheet that will be maintained in the DCC (many of the iLIGO monuments are not in the DCC archives). In addition, in order to minimize confusion monuments will be labeled with an “H” or “L” to indicate the site. All new aLIGO surveyed monuments will start with 500, ie. H5xx and L5xx.

6.1 X and Y

The beam tubes axes are the ideal alignment references. However the beam tubes are inaccessible (due to bakeout) for the duration of initial alignment. Long-distance parallels will instead be established by sighting through a port in the LVEA/VEA wall to a point ~200m down the beamtube, in order to establish an axis parallel to the beamtube centerline.

Just as in the case for iLIGO, aLIGO elevation views from the HAM1 or HAM7 endcap, with suspensions and other internal components in their final positions, reveal that the aperture is fully occluded. The installation alignment procedure involves removal of access connector sections from the vacuum envelope, to obtain a view of each primary optic for installation.

Each LVEA/VEA station is provided with alignment monuments (“brass plugs”) bonded to the facility technical foundation, originally installed to aid vacuum equipment installation. These have been (and will be further) augmented by additional reference monuments (see [D970210](#) and [D980499](#)). These monuments are placed to permit convenient sighting and measurement of primary optics. Briefly, the layout provides convenient axial and transverse position references which are referred to the fundamental station coordinate references (i.e., LIGO global coordinate system origin and the beam tube termination gate valve centerlines). However, unlike these fundamental references, the chosen monuments are visible from key positions on each primary optic’s normal vector, placed near removable spools of the vacuum envelope.

The other primary function of the monuments is to permit precision alignment (primarily in azimuth) to the global coordinates set by the beam tube axes. Successive surveys by CB&I and Rogers Surveying indicate probable azimuthal errors in setting of beam tube alignment of approximately ± 3 mm (note that, due to atmospheric effects, vertical errors are generally greater; IAS will use precision levels for altitude, with calibrated correction for the curvature of the earth). A special window is provided through the LVEA/VEA wall which permits direct line-of-sight approximately 200 m down one side of the beam tube enclosure. There a monument is laid outside with reference to the previously surveyed beam tube alignment marks. By spreading the ± 6 mm total error of two monuments over a baseline of 200 m, we expect to parallel the true beam tube axis to an accuracy of ± 15 microradian. As explained in section 17, accumulation of errors from instrumentation and from intermediate transfer and reading steps is expected to yield a total error budget within the ± 100 microradian requirement and within the 50 microradian goal in a root sum square sense.

In order for the tight horizontal (transverse) relative positional requirements to be met, we must reference the same set of monuments and not introduce more error by referencing from multiple derived monuments. We intend to use the monuments and baselines in the LVEA (corner station) as indicated in Figure 1 and Figure 2 for LLO and LHO respectively. At LLO the monuments for long baselines parallel to the X and Y arms (and which base through the removable vacuum equipment spools adjacent to BSC2) already exist. On each baseline there is a monument 220 m from the vertex within the beam tube enclosure which is visible through a hole in the LVEA wall. At LHO similarly placed, new monuments will have to be established for the H1 interferometer, as indicated in Figure 2. For H2, it is not possible to get as long of a baseline as for the H1 interferometer. In this case the H2 monuments must be derived from the H1 X and Y arm baselines and the monuments should be placed to an accuracy of ± 1 mm.

Figure 1: Basic Monument Reference Approach for LLO

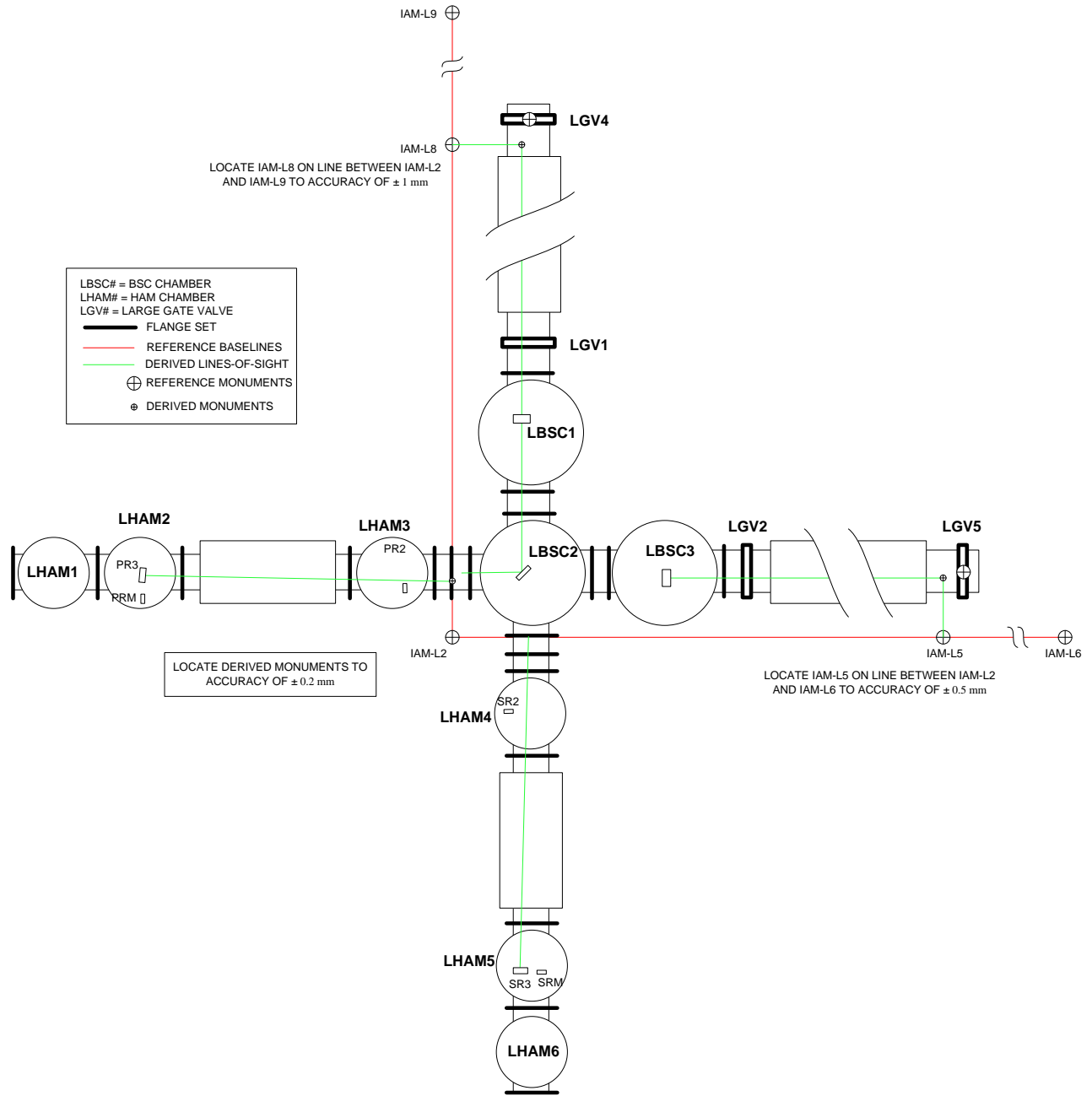
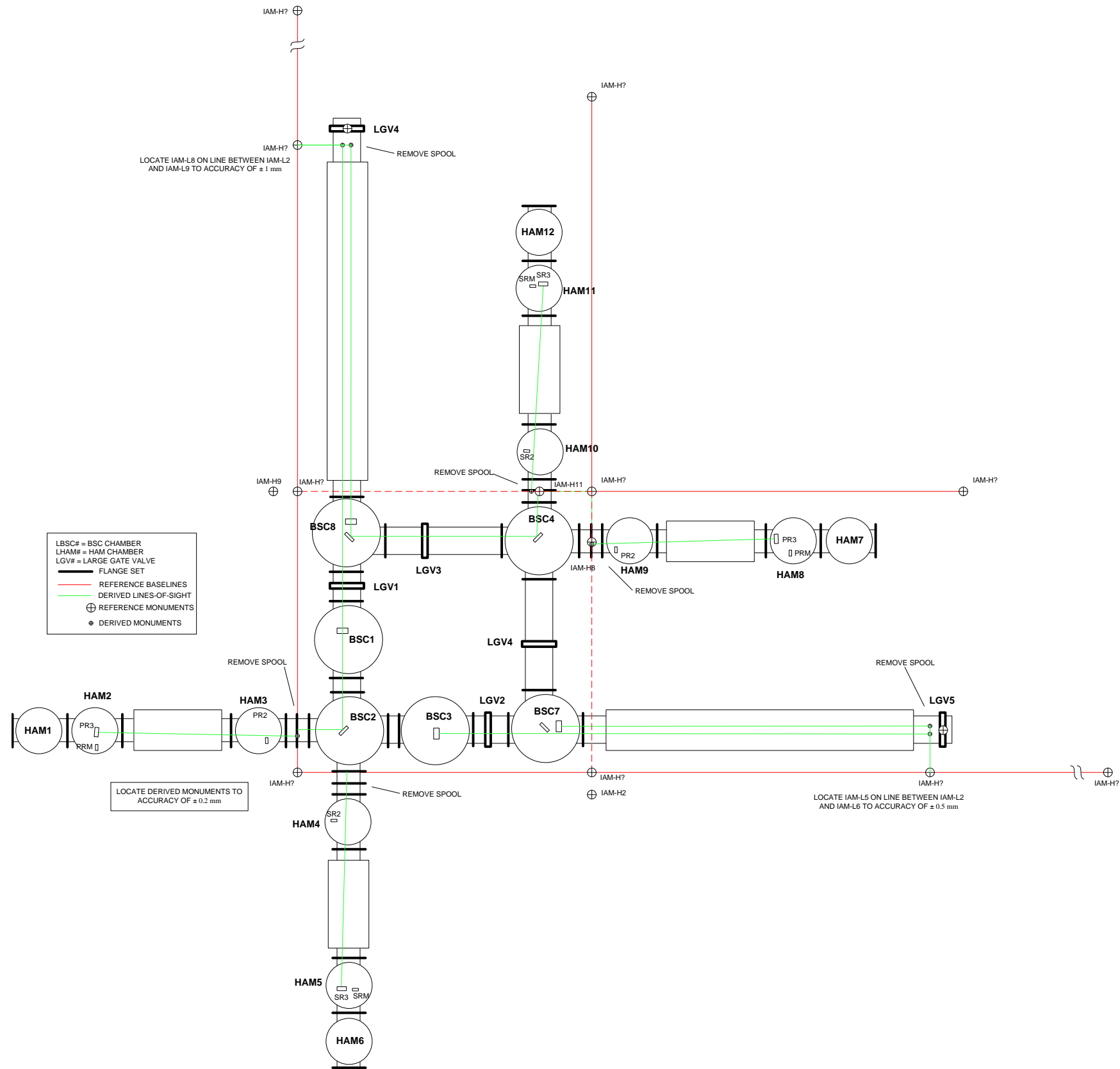

Figure 2: Basic Monument Reference Approach for LHO



6.2 Z

The vertical (Z) position is determined from actual positions of vacuum equipment flange centerlines. Reference scribe marks are located on, or near, the horizontal centerline of each flange, such as each HAM and BSC door flange. The positions of these scribe marks are measured relative to a control point. For LHO this control point was 1.0572 meters above BTVE1. Table 1 contains scribe positions in local coordinates¹. The parameter Z_{offset} in Table 1 is the difference between the calculated design values and the actual locations of the scribes. A scale is placed on the door flange such that the theodolite, or transit, can measure the Z height directly. The location of the height reference scribe marks are indicated in Figure 1 and Figure 2 for LHO and LLO respectively.

In practice, one cannot always cite one of these elevation references with the theodolite (total station) at all of the positions required. In these instances, the elevation is transferred, via an optical level or the transit, to a mark on the wall which is within view of the theodolite (total station).

¹ Taken from [T970151-x0\(C\)](#). Need to find original source to get the locations of scribe marks on flanges for LHO. The source document for the heights of the LLO vacuum equipment appears to be C990033.

Table 1 Elevation Scribe Positions (in meters)

<i>Site</i>	<i>Station</i>	<i>Scribe</i>	<i>Elevation</i>	<i>Zactual (m)</i>	<i>Zdesign (m)</i>	<i>Z(offset) (m)</i>
LHO	Corner	WGV-6	100.0000	0.0033	0.0000	0.0033
LHO	Corner	WGV-8	99.9719	-0.0248	-0.0282	0.0034
LHO	Corner	WHAM-1	99.9128	-0.0839	-0.0870	0.0031
LHO	Corner	WHAM-2	99.9028	-0.0939	-0.0955	0.0016
LHO	Corner	WHAM-4	99.9014	-0.0953	-0.0994	0.0041
LHO	Corner	WHAM-6	99.9004	-0.0963	-0.0993	0.0030
LHO	Corner	WHAM-7	99.8823	-0.1144	-0.1177	0.0033
LHO	Corner	WHAM-9	99.8931	-0.1036	-0.1076	0.0040
LHO	Corner	WHAM-10	99.8933	-0.1034	-0.1054	0.0020
LHO	Corner	WHAM-12	99.8952	-0.1015	-0.1055	0.0040
LHO	Corner	WBSC-2	99.9996	0.0029	0.0006	0.0023
LHO	Corner	WBSC-4	99.9937	-0.0030	-0.0053	0.0023
LHO	Corner	WBSC-7	99.9935	-0.0032	-0.0052	0.0020
LHO	Corner	WBSC-8	99.9993	0.0026	0.0005	0.0021
LHO	Corner	WBSC-8 SW	99.9975	0.0008	0.0005	0.0003
LHO	X-End	TBD				
LHO	Y-End	TBD				
LLO	Corner	LBSC-1	-	-0.0070	-0.0010	-0.0060
LLO	Corner	LBSC-2	-	-0.0140	-0.0010	-0.0130
LLO	Corner	LBSC1-1	-	-0.0110	-0.0020	-0.0090
LLO	Corner	LBSC1-2	-	-0.0120	-0.0020	-0.0100
LLO	Corner	LBSC1-3	-	-0.0140	-0.0040	-0.0100
LLO	Corner	LBSC1-4*	-	-0.0100	-0.0040	-0.0060
LLO	Corner	LBSC3-1*	-	-0.0130	-0.0030	-0.0100
LLO	X-End	TBD				
LLO	Y-End	TBD				

(*) indicates preferred reference scribe marks

TBD Figure

Figure 3 LHO Elevation Reference Scribe Mark Designations

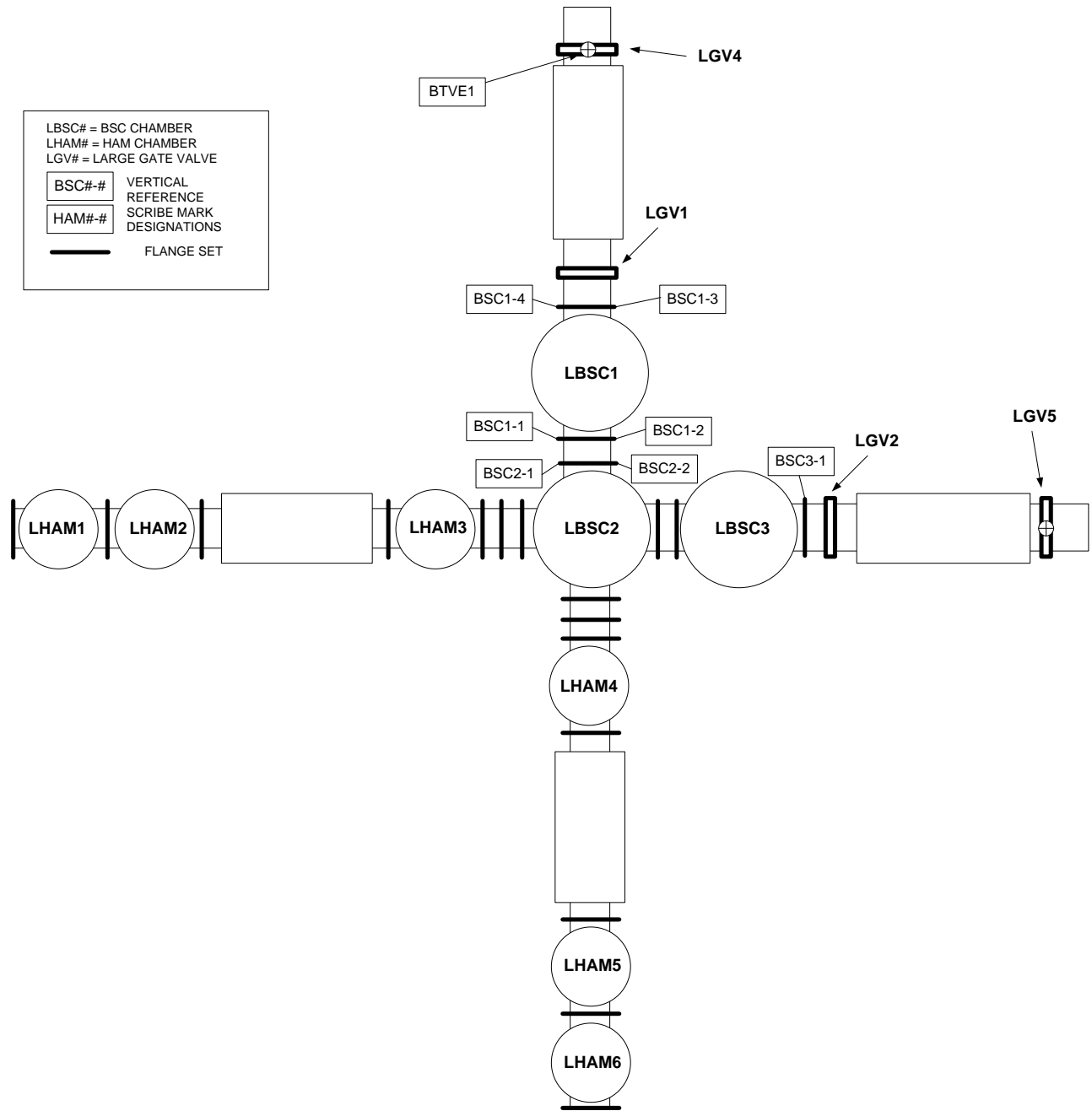

Figure 4 LLO Elevation Reference Scribe Mark Designations

The elevation reference locations & designations is taken from T970151-x0(C), which in turn was taken from an early version of [D000216-x0](#). The original source may be C990033. Note that elevation references will need to be added from the survey data records for LHAM3 and LHAM4. Once the LHAM1 and LHAM6 chambers have been relocated for aLIGO, elevations for the centerlines of their flanges will be added to the elevation reference set as well.

7 Comparison to Initial LIGO

Although the iLIGO IAS effort was successful, there are some lessons learned from initial LIGO that are addressed in the aLIGO IAS design:

- 1) The parallel, but shifted, axes of the visible autocollimator and the Total Station in iLIGO required the Total Station height to be changed when switching from one instrument to the other. This caused decreased accuracy in the alignment accuracy. For aLIGO, we have added a periscope which makes the autocollimator optical axis coincident with the Total Station. However it is not a shared aperture; the periscope blocks the Total Station aperture. Nonetheless we think that this will result in a more accurate alignment.
- 2) We are implementing an intermediate check of the co-alignment of the recycling cavities. For iLIGO the co-alignment of the power recycling cavity to the test masses was not very accurate (order of 10 mm decentering error). The co-alignment was accomplished in iLIGO with imprecise targets mounted on the MMT1 and MMT2 suspension structures. The injected MC beam and a back-propagating IR beam aligned to the test mass was checked for overlap on the MMT1 and MMT2 targets. For aLIGO we will perform a check on the co-alignment of the P(S)RM, P(S)R2 and P(S)R3 optics. This check will be performed either with the red Total Station beam, or the IR laser autocollimator beam.
- 3) We will also implement a window and target in a temporary septum plate between HAM3 and BSC2 to check the alignment of the injected beam; see section 13.2.
- 4) The relative alignment of the optics was checked for iLIGO with the COS infrared laser autocollimator. However the power was marginal, even with a 4W source was somewhat marginal. A higher power source will be sought for aLIGO.
- 5) Optic centering for iLIGO was accomplished with targets mounted to the suspension structure which were not well registered to the optic center (or by referencing marks on the structure). For aLIGO the centering target will be embedded in the retroreflector on a mount which can be positioned relative to the optic in a repeatable manner. In addition a CMM will be used to measure the target relative to the optic center.
- 6) Off-center autocollimation of the test masses will be employed in order to keep First Contact™ on the optic to mitigate particulate contamination.
- 7) Optic table leveling was performed with bubble levels for iLIGO. This approach had limited accuracy (~0.3 mrad) due to the need to use UHV foil at the interface with the table, the short baseline available on a crowded table and the difficulty in mounting and reading a level on the inverted BSC optics tables. For aLIGO we will use bubble levels for initial leveling and quick checks, but optical targets and an optical level for precision leveling (~0.05 mrad).
- 8) The fast response time of the visible laser autocollimator (670 nm) digital controller display makes it difficult for the operator to make adjustments to zero the angular error. We plan to display a low pass filtered version of the analog output of the Newport controller to help the operator.

8 Equipment

Much of the instrumentation used for installation alignment is relatively standard in the surveying and millwright trades. Brief descriptions of the key chosen equipment are given below to help the reader understand the methodology and error budget. In addition to this commercial-off-the-shelf instrumentation, there are a number of custom tooling needed for the IAS procedures. This equipment is briefly explained below and in the outline of the alignment procedures in the following sections.

All of the commercial-off-the-shelf and custom equipment needed for initial alignment is listed in [E1000827](#).

8.1 Optical Level

Both observatories have precision optical level instruments which we will use on tripods to set the optical table heights and level the tables in tip and tilt. In addition new optical levels with somewhat better accuracy are being purchased for the aLIGO IAS effort. The new optical levels are Sokkia B2o AutoLevel with micrometer option:

Accuracy 0.5mm (0.02in) (standard deviation for 1km double run leveling)

Resolution: 0.01 mm.

Field of view: 1°,20' (2.3m@100m)

Setting accuracy 0.3" (15 microrad)

see brochure for full details [T1100064](#)



Figure 5 Precision Optical Level

8.2 Optical Transit Square

A transit square is used in concert with a precision theodolite to step off accurate right angles for establishing parallels. We will use a Brunson 75-H optical transit square to establish an axis parallel to the beam tube centerline. This instrument has a 30x telescope (1 degree field of view) and is equipped with a micrometer (for accurate parallel translation) and a coincidence vial level (for sub-arcsecond leveling). An integral precision optical flat is mounted with its surface parallel to the telescope axis, such that a beam retroreflected from this mirror is precisely normal to the transit sight. The plunge axle is hollow (and the mirror has parallel front and back surfaces) such that this mirror is visible from both sides of the instrument.

The transit square is also equipped with an optical plummet, which permits lateral placement of the transit axes directly over a predetermined floor mark.

Each observatory has two Brunson optical transit squares.



Figure 6 Brunson Optical Transit Square (model 75-H)

8.3 Total Station

A distance-measuring theodolite (Total Station) is used to both position and dial in correct angles for each primary optic. The theodolite will be modified to accept and boresight the autocollimator; its built-in autocollimation function is inadequate for the distance, reflectance range and angular accuracy required.

For iLIGO, we used the Sokkia Set2BII electronic total station theodolite to preset pitch and yaw angles of suspended optics and to determine their lateral and axial positions. For aLIGO we will re-use these instruments but in addition use the Sokkia SetX1 Total Station. Both Total Stations incorporate a 30x telescope (1.5 degree field of view), measure distance with a laser rangefinder² with an accuracy of 2 mm, and measure angles to an accuracy of 1 arcsec (5 microrad).

The Sokkia model SetX1 also has a 690nm (red), 5mW (class 3R) pointing beam (~13mm dia.) which is co-axial with the viewing aperture. The deviation of the beam relative to the main beam (1064 nm) is within acceptable error limits (see section 9.4). Depending upon the precise value of the reflectances of the recycling cavity optics at 690 nm, it may be possible to retroreflect the Total Station beam off of the three recycling cavity optics (PR3, PR2 and PRM, as well as SR3, SR2 and SRM). If the reflectance values are all at the upper end of the values given in Table 3, then 3 microW of power returns for the PRC and 7 microW for the SRC. If the reflectances are at the lower range of the expected reflectance band, then this beam may still be useful as a pointing beam, using a target or camera at the P(S)RM optic.

Since the optic will not be aligned normal to the theodolite beam until alignment has been completed, a corner cube retroreflector is mounted to the suspension structure to enable precise axial range determination.

Each observatory will have two total stations (one model Set2BII and one model SetX1). Two Total Stations will permit simultaneous installation alignment and alignment support during assembly of an optic into a suspension. A third SetX1 is shelved as a spare.

² Transverse positions, which need greater accuracy, will be determined by a steel reference tape.



Figure 7 Total Stations to be used for aLIGO

The handles at the top will be removed and a laser autocollimator added.

8.4 Electronic Visible Laser Autocollimator

The theodolite is modified by retrofitting a laser autocollimator and boresighting it to coincide with the theodolite axis. For aLIGO we will use the same visible laser autocollimator used for iLIGO, the Newport LDS Vector and LDS1000 controller. Three additional units were purchased so that all Total Stations have dedicated laser autocollimators (1 as a spare).

The Newport LDSVector operates at 670 nm wavelength with a 31 mm diameter beam, 100 μ rad divergence and 0.9 mW output (class II). It has a ± 2 mrad field of view, a range of 20 m and an accuracy of 1 μ radian.

The autocollimator provides an electronic readout indicating the degree to which a mirror in its view is misaligned to its axis. It is made parallel to the theodolite (total station) axis by setting up a large reference flat mirror with its face vertical. The theodolite is adjusted to autocollimate off of this reference flat. The laser autocollimator is then adjusted with the goniometer mount to set it to also autocollimate off of the reference flat. By adding a periscope (with a length equal to the separation between the laser autocollimator and theodolite apertures) the two instruments have coincide optical axes (although the periscope blocks the theodolite aperture).

We may add the use of Stanford Research System SR 560 Low Noise Preamplifier to slow and amplify (10x Gain) the laser collimator signal response allowing the pointing traces to be followed easier both on a scope traces and the digital display.

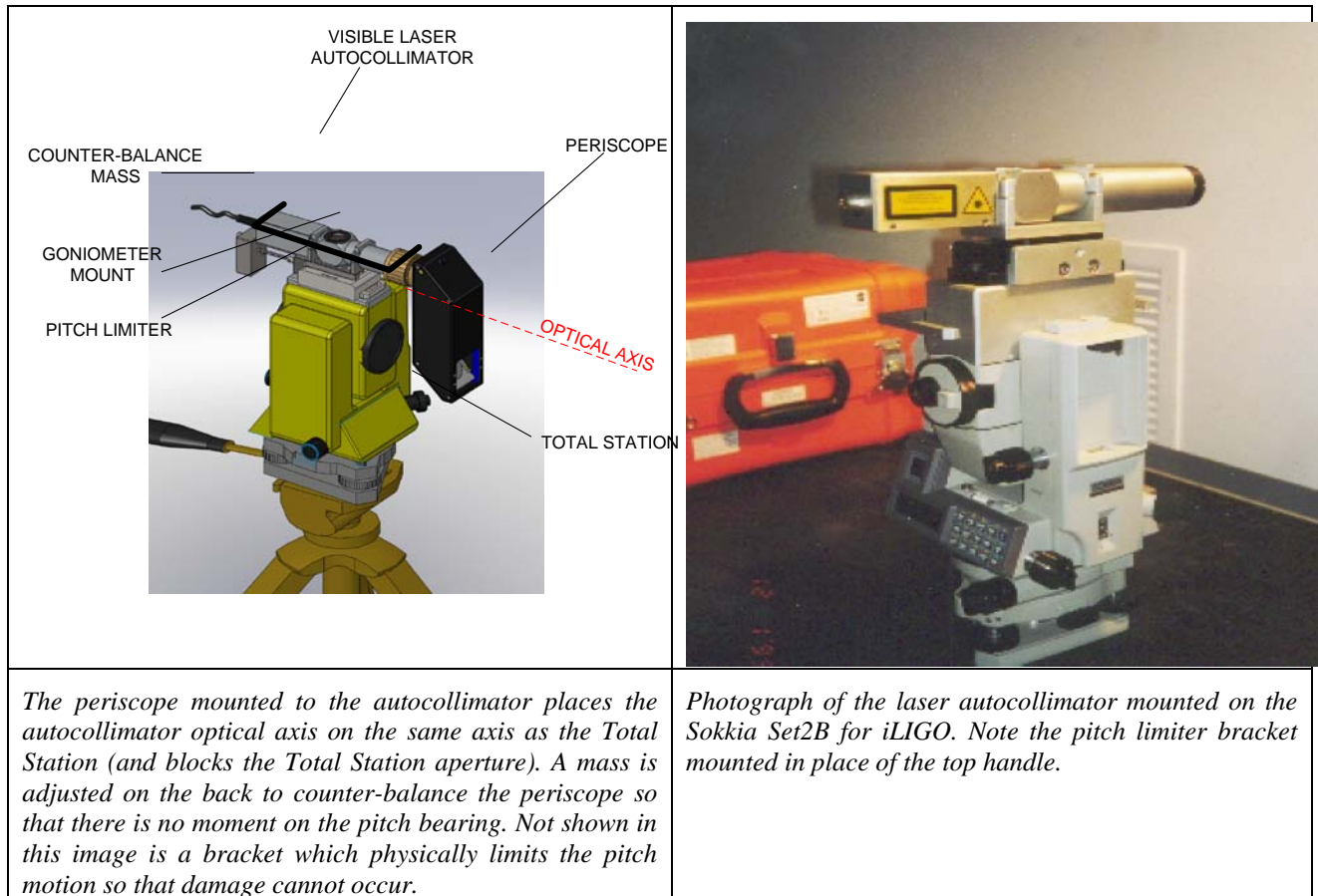

Figure 8 Visible Laser Autocollimator mounted on the Total Station Gimbal

8.5 Infrared Laser Autocollimator

The iLIGO COS infrared laser autocollimator³ will be used in aLIGO to perform a final alignment check by propagating a beam through the optical system to check the relative alignment of the optics and to generate the ghost beams in the system. The COS infrared (IR) autocollimator is based on a Davidson Model D-271-106 alignment telescope used both as a projection alignment telescope and as an autocollimator. The autocollimation feature is used to pick up the alignment from a (previously aligned) optic such as a test mass. The autocollimator minimum scale division is 30" (145 microradians), so the resolution is ~35 microradians (1/4 of a division). Then the projection telescope is used to propagate a beam through the optical train.

A 4 W fiber-coupled infrared laser @ 940 nm from Applied Optonics Corp. is used as the light source for propagating through the system and illuminating the internal reticle. The laser is coupled to a 100 micron diameter fiber with a NA=0.2, which results in a 23 degree full angle light cone. The cone is transformed with a lens to match the NA=0.1 of the alignment telescope and thereby achieve high transmission through the alignment telescope. The collimating optics of the alignment telescope are AR coated at 500nm and 940nm to enable operation both with visible light and

³ M. Smith, COS IR Autocollimator Alignment System, [T980072-v1](#)

infrared light sources. A holographic diffusing screen may be placed in front of the reticle to provide uniform illumination.

For iLIGO the illumination of the IR autocollimator/alignment telescope was sufficient to enable the weakest ghost beam projected reticle to be viewed with a sensitive commercial surveillance camera, such as the Watec WAT-902H with a minimum luminous sensitivity of 0.0003 lux. We expect the same to be true for aLIGO. However, when propagating through the optical system from the input test mass to the PRM, the illumination was a little marginal. As a consequence we will seek a somewhat brighter source.

8.6 Coordinate Measuring Machine (CMM)

Each observatory has two CMM arms, one large and one small. The small CMM is an eMicroScribe model MX with a 25 inch reach and a .002 inch accuracy. The large CMM is a ROMER model Infinite 2.0 with a 9 ft reach and a .0016 inch accuracy. These CMMs are used to measure the positional offsets of targets and retroreflectors to the center of the optic.

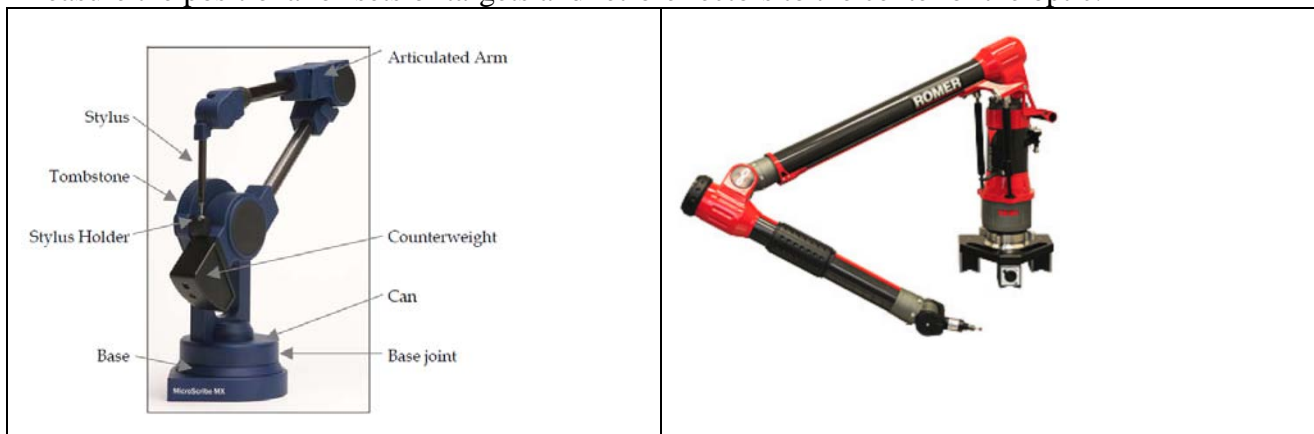

Figure 9 CMMs for aLIGO

8.7 Lateral Transfer Retroreflectors

The preferred approach to aligning an optic is to autocollimate off of the optic's HR face. In some instances this is not possible (or may be difficult due to other constraints). In this case a lateral transfer retroreflector may be employed, as depicted for example in Figure 8 (and [D1002908](#)) for the alignment of H2-PR2. We intend to re-use the PLX lateral transfer retroreflector employed in initial LIGO which has a 15.748 inch (40.0 mm) offset and maintains a parallelism of < 10 microradians between the input and output beams. Each observatory has a single lateral transfer retroreflector.

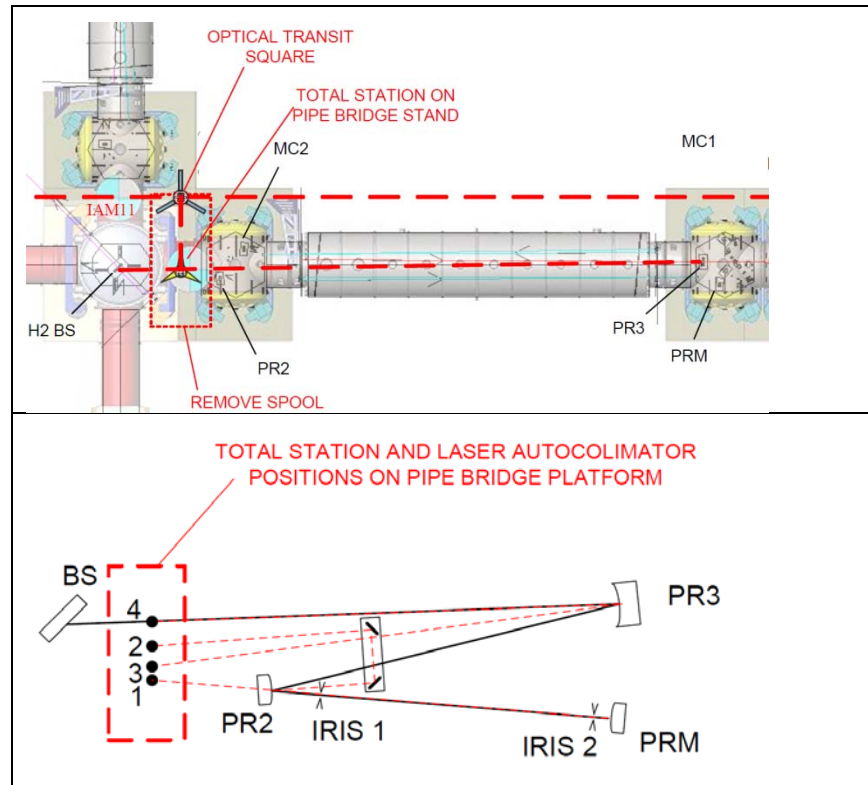

Figure 10 Use of a lateral transfer retroreflectors

The lateral transfer retroreflectors is used to align the PR2 optic from its HR face (shown for H2).

9 Characteristics of the Primary Optics

9.1 Optical Layout

The optical layout (topology) is given in the following documents:

- Optical Layout Schematic: H1 & L1 [D0902838](#), H2 **TBD**
- Key Coordinates and Cavity Lengths (T080078)
- Optical Layout & Parameters [T0900043](#)
- Optical Layout eDrawing⁴ (H1 [D0901920](#), H2 [D0902345](#), L1 [D0902216](#))

9.2 Locations and Orientations

The locations and orientations of the optics are defined in the following references in both global and local coordinates:

- LIGO-D0901920: [Advanced LIGO H1 Optical Layout, ZEMAX](#)
- LIGO-D0902345: [Advanced LIGO H2 Optical Layout, ZEMAX](#)
- LIGO-D0902216: [Advanced LIGO L1 Optical Layout, ZEMAX](#)

⁴ At the time of writing this document the latest versions of these documents do not yet have eDrawings posted. Previous versions are close to the current optical layout. These documents will be updated.

The transformation from global to local coordinates is defined in [T980044-v1](#) (-10). See also the drawing, [D950148-v2](#), depicting the location and orientation of the beam tube centerlines (global X & Y axes) relative to the building floor and local level (local coordinate frame). The direction cosines of the of the global axes in the local coordinate frame (aligned to the local gravity vector) are given in Table 2.

Table 2 Global Direction Cosines (microradians)

	Corner	End
LHO, X-Arm	-619	7.84
LHO, Y-Arm	12.5	639
LLO, X-Arm	-312	315
LLO, Y-Arm	-611	18.8

9.3 Optical coating reflectance and transmission

The reflectance spectra for the recycling cavity optics has been calculated for the CSIRO coating designs, with the exception of the FM. The FM requires a coating redesign to enhance performance at 532 nm (for the Arm Length Stabilization system) and 840 nm (for the Hartmann Wavefront Sensing system). In the interim before we receive a revised FM coating design, a suggested coating design⁵ has been used to estimate the FM reflectance. It has been suggested⁶ that a reasonable estimate of the tolerance on the reflectance can be obtained by shifting the spectra by 1% of the desired frequency. This was done to determine the reflectance from each of the optics at 670 nm (for the IAS visible laser autocollimator) and 940 nm (for the IAS IR laser autocollimator) wavelengths (see table and figures below).

The minimum reflectance required for the Newport LDS1000 autocollimator (@ 670 nm) is 2%. All of the primary optics have reflectances at 670 nm above 2%, with the exception (possibly) of PR2 and F-PR2 (Table 3). The reflectances given in Table 3, and the following figures, are all theoretical. In addition, the range in values is an estimate of the likely range in values when the coating is produced.

⁵ R. Dannenberg, "CSIRO original designs with the 532 and 532+841 nm enhanced FM", [C1001803-v1](#)

⁶ R. Dannenberg suggested 22-Sep-2010 that one can use a $\pm 1\%$ shift in the wavelength (around the frequency of interest) to approximate systematic coating errors as well as random thickness errors. While he did not know what thickness variation this corresponds to, he thought that this was reasonably realistic. A Monte Carlo coating simulation with known parameter/thickness variations would be a better estimate of the reflectance spectra uncertainties, which is what was done for the test mass coatings. Of course doing a series of coatings runs would be best measure of uncertainties in coating performance.

Table 3: Reflectance of Primary Optic Surfaces (at 670 nm and 840 nm)

N.B.: The FM HR coating will be redesigned to optimize reflectivity at 532 nm; this may change the reflectivity at Optical Lever wavelengths.

Optic	surface	Reflectance	
		670 nm	940 nm
ETM	HR	6.0% – 18.4%	38.3 % – 80.9 %
ITM	HR	13.6% – 30.6%	3.9 % – 41.8 %
BS 50/50	50/50	4.8% (p) – 7.6% (p) 20.9% (s) – 27.3% (s)	34.6 % (p) – 38.9 % (p) 71.1 % (s) – 74.4 % (s)
FM	HR	11.9% (p) – 19.9% (p) 17.4% (s) – 41.9 % (s)	2.4 % (p) – 72.6 % (p) 100.0 % (s)
PR3	HR	7.2 % – 25.0 %	3.6 % – 98.0 %
SR3	HR	5.1 % – 15.4 %	0.6 % – 95.4 %
CP, SR3, PR3	AR	19.9 % -- 20.7 %	1.5 % -- 2.0 %
BS, FM	AR	4.7 % (p) – 5.0 % (p) 21.6 % (s) -- 22.3 % (s)	0.3 % (p) – 0.4 % (p) 3.9 % (s) – 4.4 % (s)
ITM	AR	30.3 % -- 34.6 %	5.2 % -- 8.5 %
PR2, F-PR2	HR	1.2% -- 19.7%	13.3% -- 42.2%
SR2, F-SR2	HR	2% -- 50%	TBD
PRM, F-PRM	HR	10.8% -- 24.0%	44.5% -- 75.5%
SRM, F-SRM	HR	21% -- 24%	53% -- 65%
PR2	AR	TBD	TBD

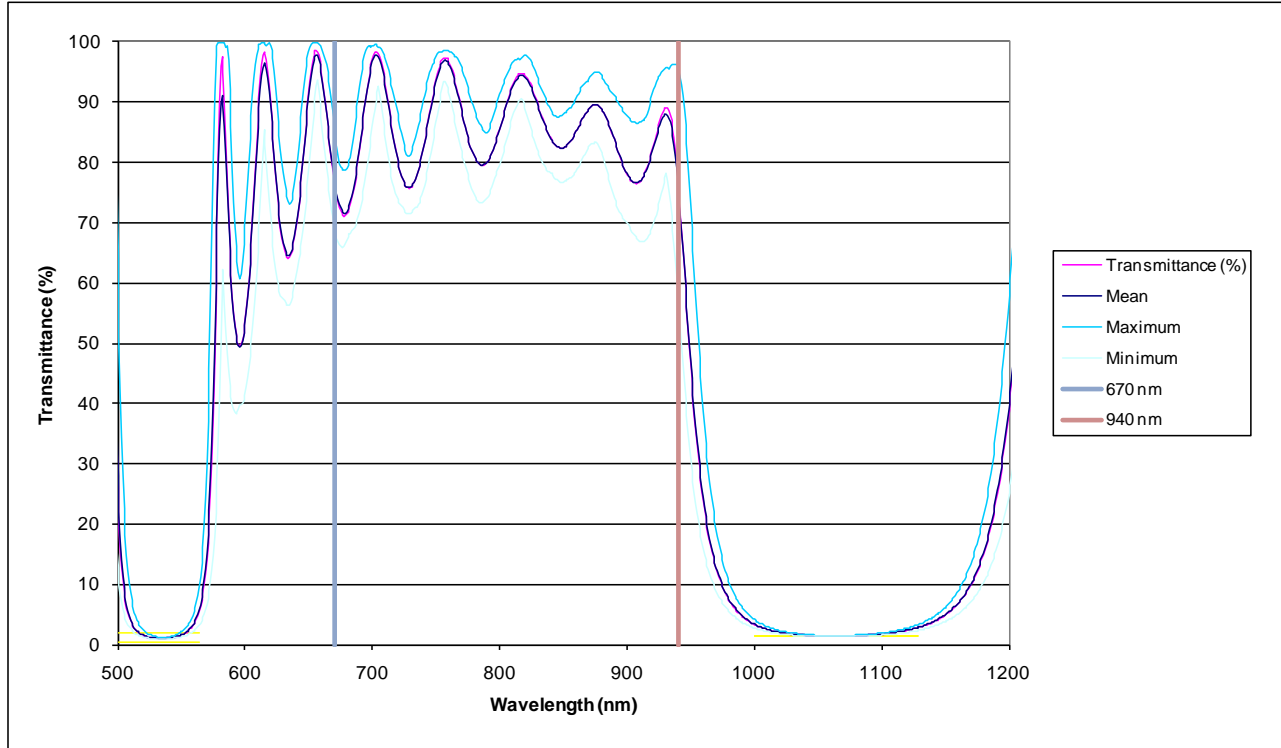

Figure 11: ITM HR Transmittance vs wavelength (design).

(using data from LIGO-C1000029-v1)

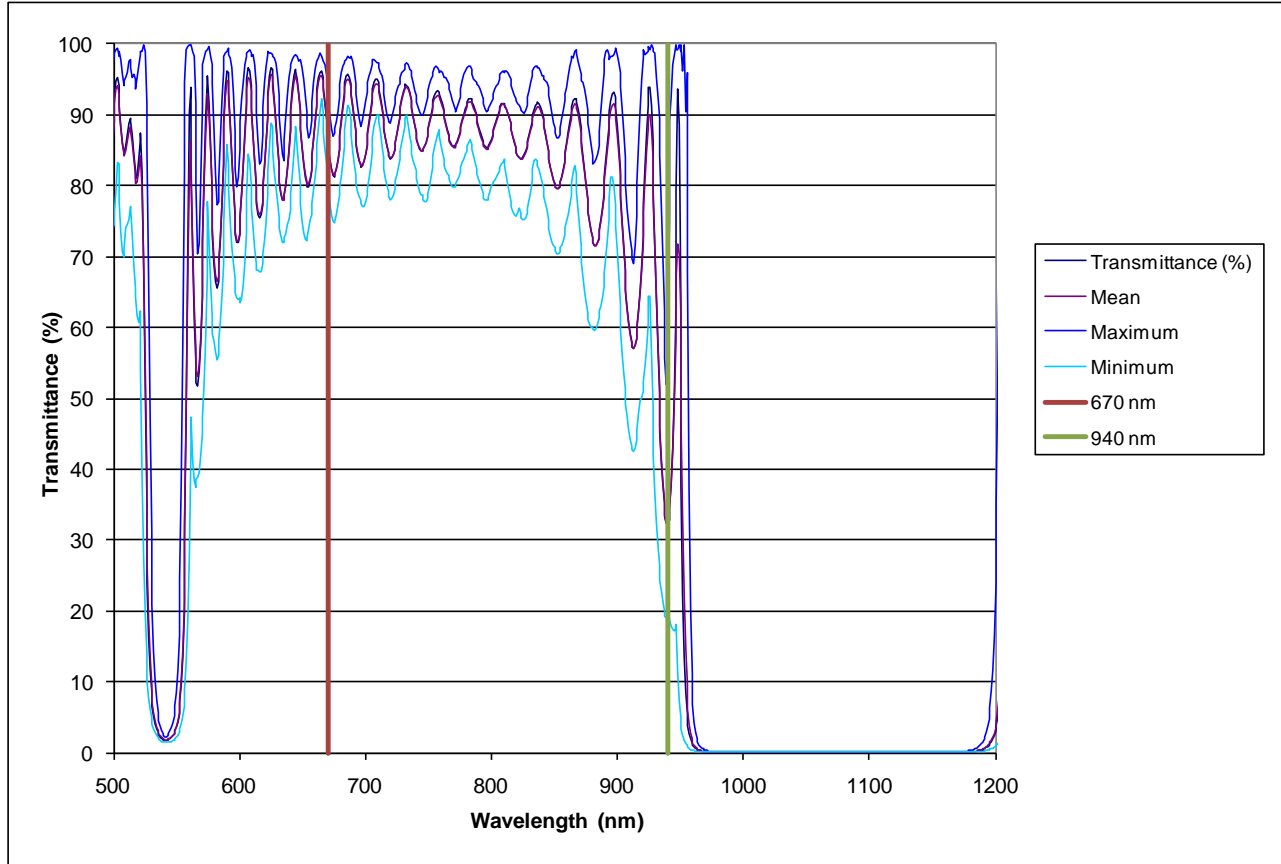

Figure 12: ETM HR Reflectance vs Wavelength (design).
(using data from LIGO-C1000251-v2)

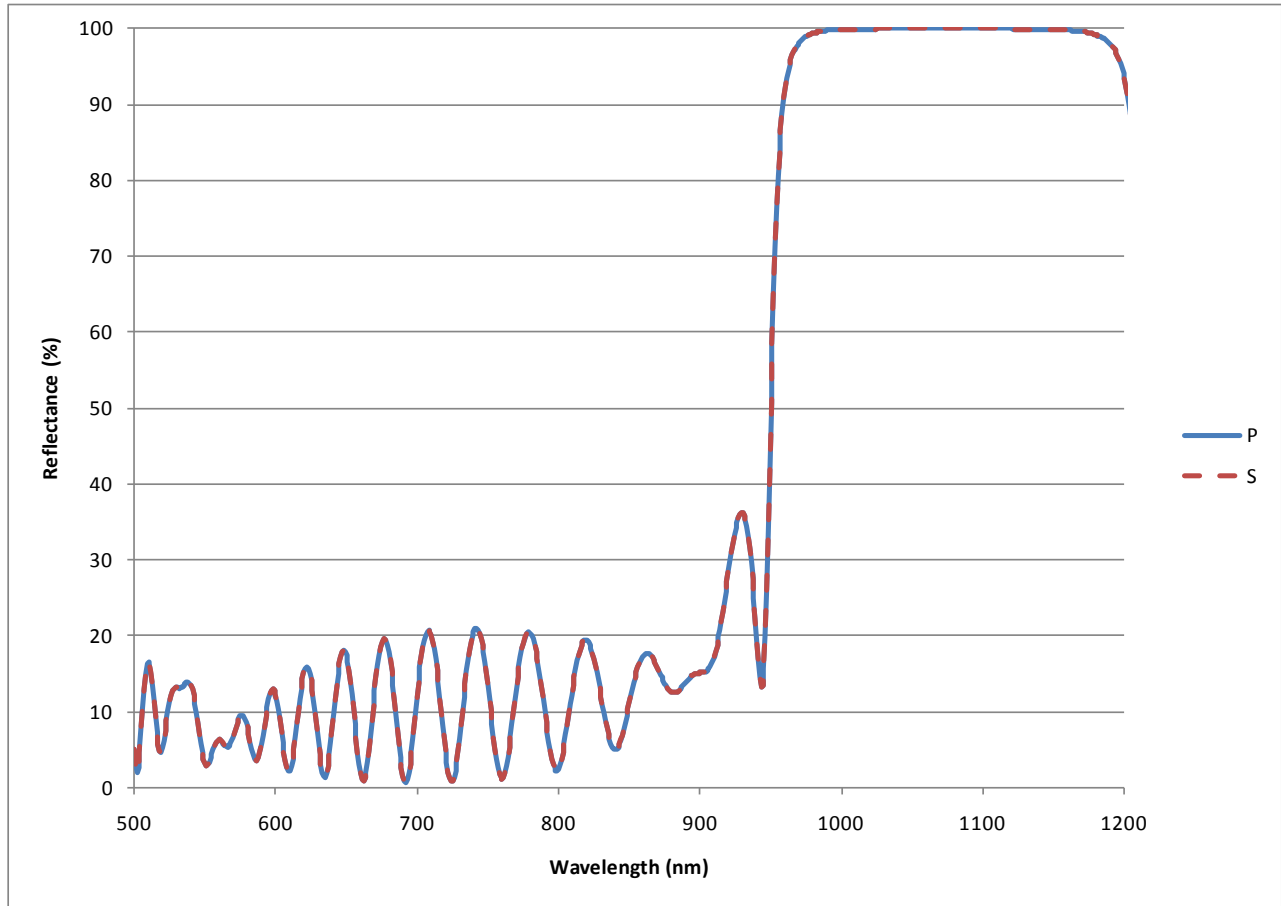

Figure 13: PR2 and F-PR2 HR Reflectance Spectra

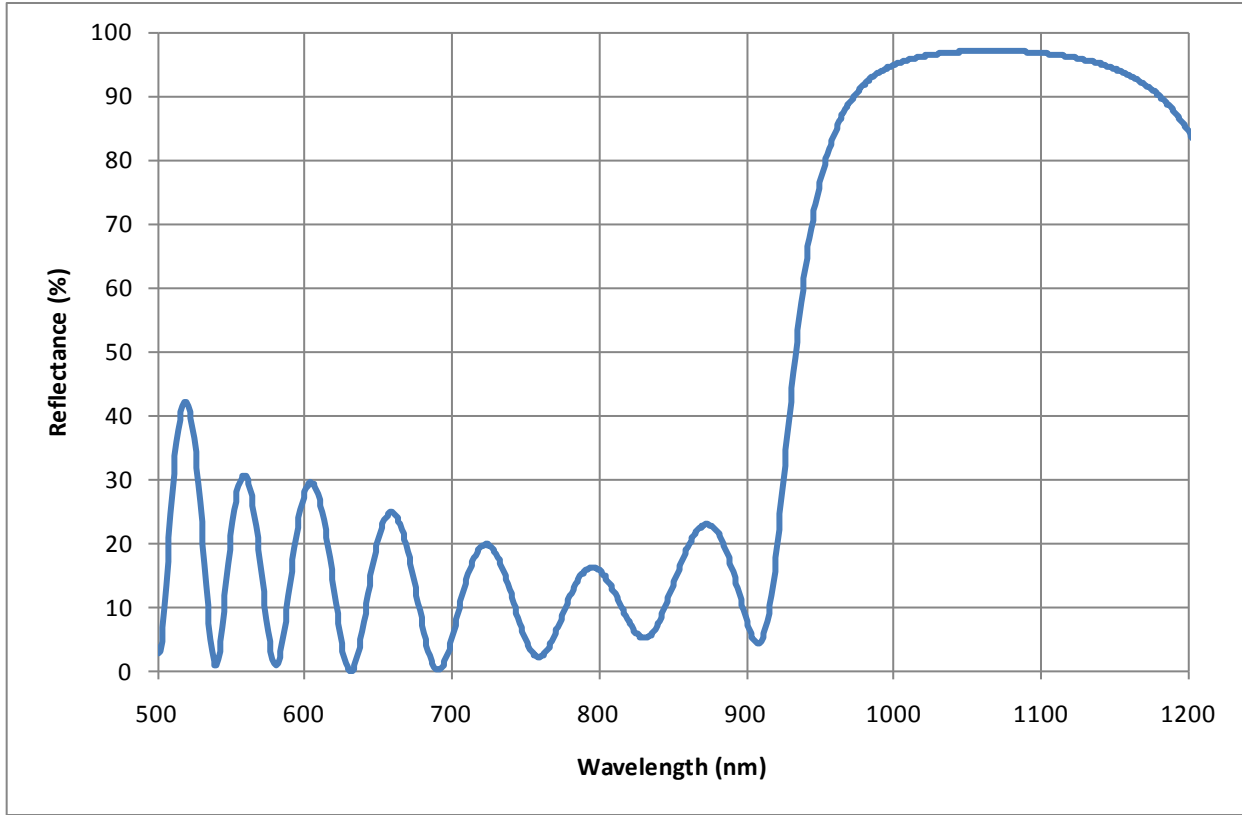

Figure 14: PRM & F-PRM HR Reflectance Spectra

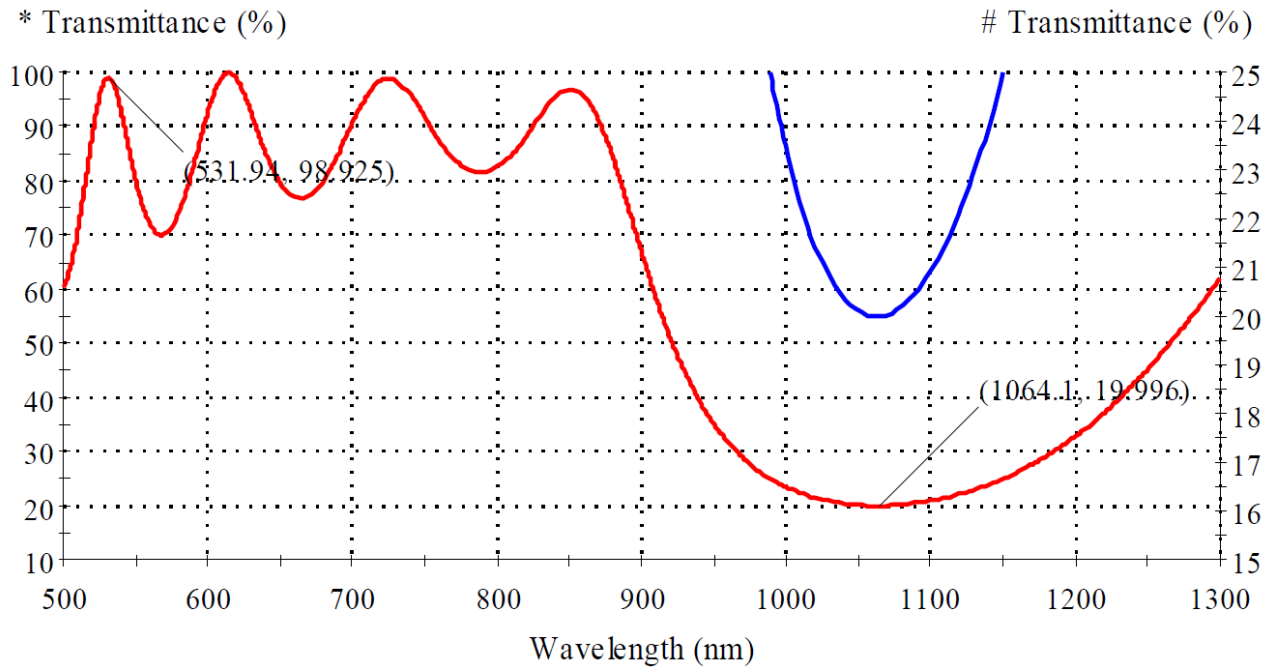

Figure 15: SRM & F-SRM HR Reflectance Spectra

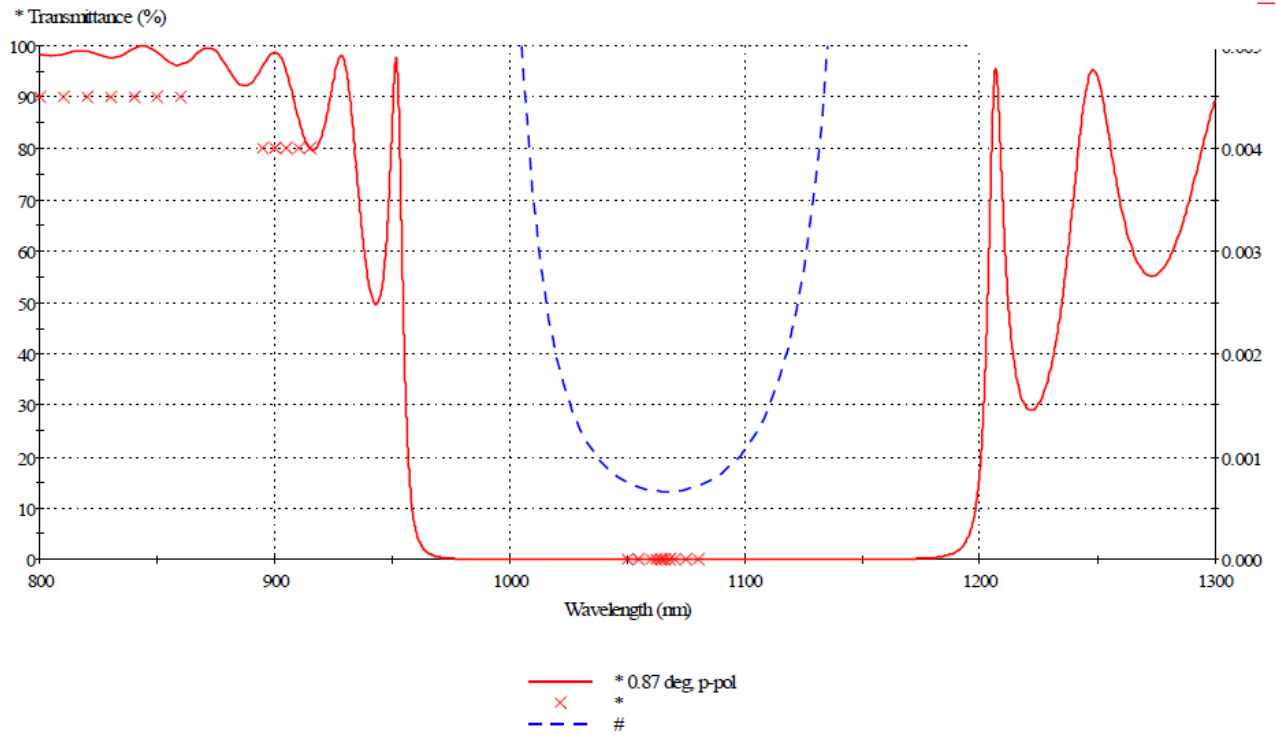

Figure 16: SR2 & F-SR2 Reflectance Spectra

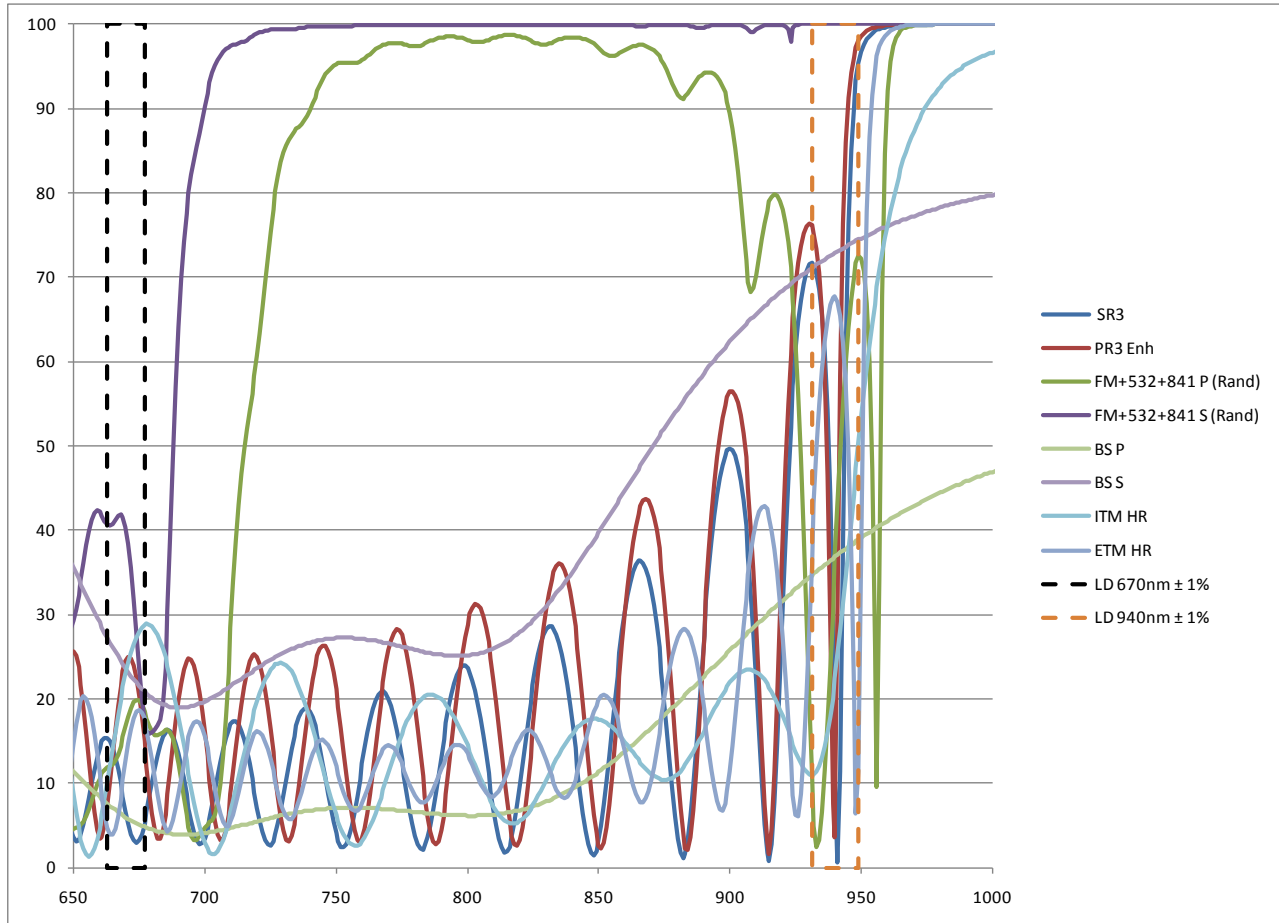

Figure 17: BS, FM, PR3 and SR3 Reflectance vs Wavelength (design).

The reflectance spectra for the SR3, PR3 (enhanced at 532 nm) and BS are from CSIRO designs. The reflectance spectra for the FM is a design by Rand Dannenberg enhanced at 532 nm and 840 nm (using data from LIGO-C1001803-v1); We will receive a CSIRO design soon. The reflectance spectra for the ITM and ETM are for approved designs from LMA.

9.4 Chromatic error

The deviation of the alignment beams relative to the main 1064 nm beam is within the allowable de-centering error, as indicated in Table 4.

Table 4 Chromatic Error

	Mirror coordinate, mm					
Wavelength (nm)	PR3 vert	PR3 horiz	PR2 vert	PR2 horiz	PRM vert	PRM horiz
1064	112.9	9314.8	149.6	9750.5	168.4	8569
670	113.2	9314.9	149.7	9750.4	169.8	8568.4
840	113.1	9314.8	149.6	9750.5	169	8568.7
Error 670 nm	-0.3	-0.1	-0.1	0.1	-1.4	0.6
Error 840 nm	-0.2	0	0	0	-0.6	0.3

The results in the table are for the H2 interferometer along the X-arm. The beams are propagated from the arm cavity to the PRM. Note that the calculation should have been performed for 940 nm, not 840 nm, since this is the wavelength of the IR laser autocollimator. However since the fused silica refractive index varies monotonically with wavelength, the error at 940 nm will be less.

10 Basic Alignment Sequence

10.1 HAM Chamber Payloads

This alignment is done within each HAM chambers. The basic steps are as follows:

- 1) Establish the optical alignment axis
- 2) Align the optics table in 6 degrees of freedom (DOF) without real payload (only weights)
- 3) Approximately align payloads (mostly suspensions) with templates
- 4) Optically align each optic assembly

Each of these steps will be fleshed out into detailed procedures, with written checklist steps. The procedures will reference the following layout drawings for these alignments:

- LIGO-D1002648: [IAS Layout for H1 PR3, PR2, PRM](#)
- LIGO-D1002649: [IAS Layout for H1 SR3, SR2, SRM](#)
- LIGO-D1002908: [IAS Layout for H2 PR3, PR2, PRM](#)
- LIGO-D1002909: [IAS Layout for H2 SR3, SR2, SRM](#)
- LIGO-D1002915: [IAS Layout for L1 PR3, PR2, PRM](#)
- LIGO-D1002916: [IAS Layout for L1 SR3, SR2, SRM](#)

The alignment parameters for the payloads are given in Table 5.

Table 5 Alignment Parameters

IFO	Optic				Transit Square					Total Station										Baseline Distances		Uncertainty	
	Name	Building Coordinates, Gravity Aligned (mm)			Over Monument:			Sights Monument:		Monument			Height Reference		LOS distance (mm)	Retro offset (mm)	EDM (mm)	Yaw (microrad)	Pitch (microrad)	horizontal	vertical	Yaw (microrad)	Pitch (microrad)
		X	Y	Z	Name	X (mm)	Y (mm)	Name	X (mm)	Y (mm)	Name	X (mm)	Y (mm)	Name									
H1	PRM	-20204.8	-653.4	-81.9		-1854.2	-1854.2											-1° 34' 30.6"	26				
	PR2	-3588.1	-530.2	-82.3														0° 25' 22.8"	-1230				
	PR3	-19740.0	-171.9	-82.4														0° 39' 9"	8				
	OFI	#N/A	#N/A	#N/A														#N/A	#N/A				
	SRM	305.3	-19877.2	-113.9														86° 37' 46.8"	22				
	SR2	-594.3	-4160.4	-103.8														87° 33' 5.4"	13				
	SR3	-156.9	-19614.8	-94.6														89° 9' 16.2"	3				
	BS HR	-198.6	-183.6	-82.8														45° 2' 27.6"	-428				
	ITMx	5001.0	-200.0	-83.1														-1° 59' 60"	619				
	ITMy	-200.0	4998.1	-79.8														89° 59' 60"	12				
	ETMx	-498.9	-200.0	-80.0														0° 0' 0"	8				
	ETMy	-200.0	-501.9	-80.0														89° 59' 60"	-326				
H2	F-PRM																						
	F-PR2																						
	F-PR3																						
	OFI																						
	F-SRM																						
	F-SR2																						
	F-SR3																						
	BS HR																						
	FMx																						
	FMy																						
	ITMx																						
	ITMy																						
	ETMx																						
	ETMy																						
L1	PRM																						
	PR2																						
	PR3																						
	OFI																						
	SRM																						
	SR2																						
	SR3																						
	BS HR																						
	ITMx																						
	ITMy																						
	ETMx																						
	ETMy																						

10.1.1 Establish the Optical Alignment Axis

In general one establishes an alignment axis by picking up a parallel axis from some nearby alignment monuments and laterally transferring this axis using an optical square and a theodolite (or total station), as depicted in Figure 12 for the input optics of the H1 interferometer.

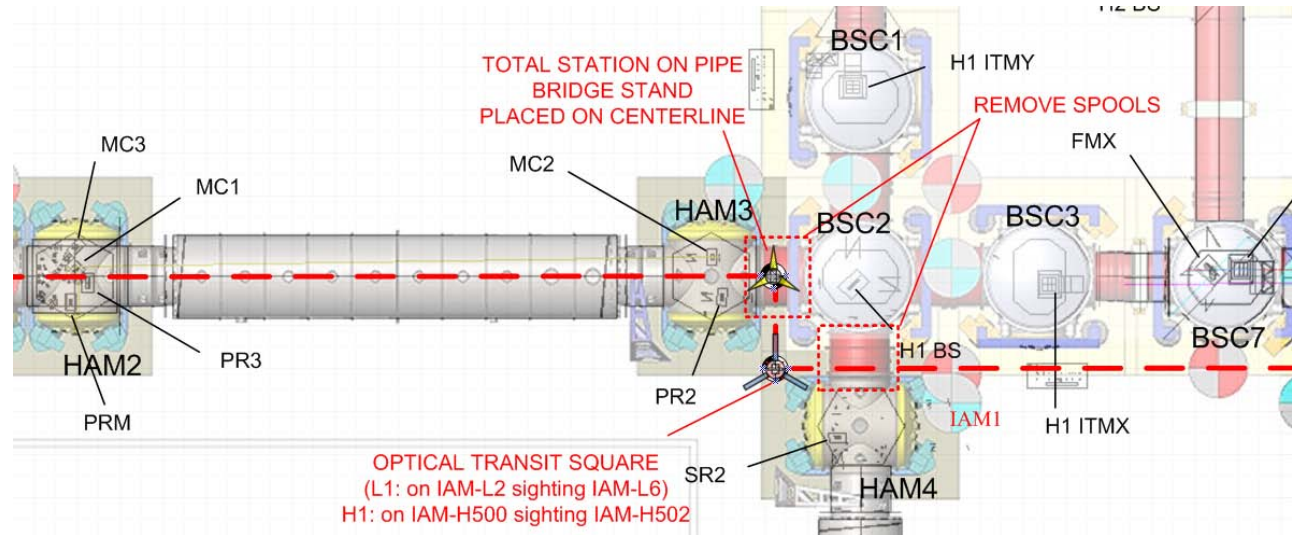

Figure 18 Establishing the Optical Alignment Axis for the input HAM-ISI tables

(IAM denotes Initial Alignment Monument)

For the input HAM-ISI optics tables (HAMs 1, 2, 3) an optical transit square positioned on monument IAM-L2 for interferometer L1 and on IAM-H500 (new) for interferometer H1 and sights a distant monument (IAM-L6 for L1 and IAM-H502 (new) for H1) to establish an optical axis parallel to the global x-axis with high angular accuracy. Note that this requires removal of two vacuum equipment spool pieces (between HAM3 and BSC2 and between HAM4 and BSC2). The Total Station, positioned on a bridge stand spanning the space where a vacuum envelope spool between HAM3 and BSC2 has been removed, serves to transfer the optical axis laterally. If the total station is positioned on the chamber/arm centerline, set to retro-reflect off of the optical transit square, and then turned 90 degrees precisely, then the vertical centerline plane can be established and used to adjust the tables.

To use the Total Station to optically align specific input optics, the Total Station is placed at an appropriate lateral position and turned an appropriate angle, as indicated for example in [D1002908](#).

10.1.2 Optics Table Alignment

The HEPI static positioning capability (using the 8 offload spring adjustments) will be used to adjust all six rigid body degrees of freedom of the optics table. However, it is particularly important to set the table to be level (pitch and tilt) and at the proper elevation. Any residual errors in the HAM table yaw and in-plane translation (x, y) can be accommodated when setting the alignment of each individual optical payload.

The tolerances of the HAM-ISI assembly result in a maximum uncertainty in location and orientation of the HAM optics table, relative to the support tube interface of ± 0.087 in laterally (± 2

mm), ± 1.7 mrad yaw and ± 0.4 mrad tip and tilt. In addition to this tolerance stackup error, there is even greater uncertainty in the positioning of the support tubes.

An optical level will be used to sight the height of the optics table relative to the scribe lines on the chamber flanges using scales mounted vertically to the table. Four scales mounted at the left, right, fore and aft edges of the table will be used to guide the table level (roll & pitch) and to the proper height (z) using the static positioning capability of the HEPI system (see Figure 13). Ideally this alignment of the optics table is performed before the payload has been added to the table (when only weights are on the table). However, this procedure can be performed after the payload has been added as well (as illustrated in Figure 13).

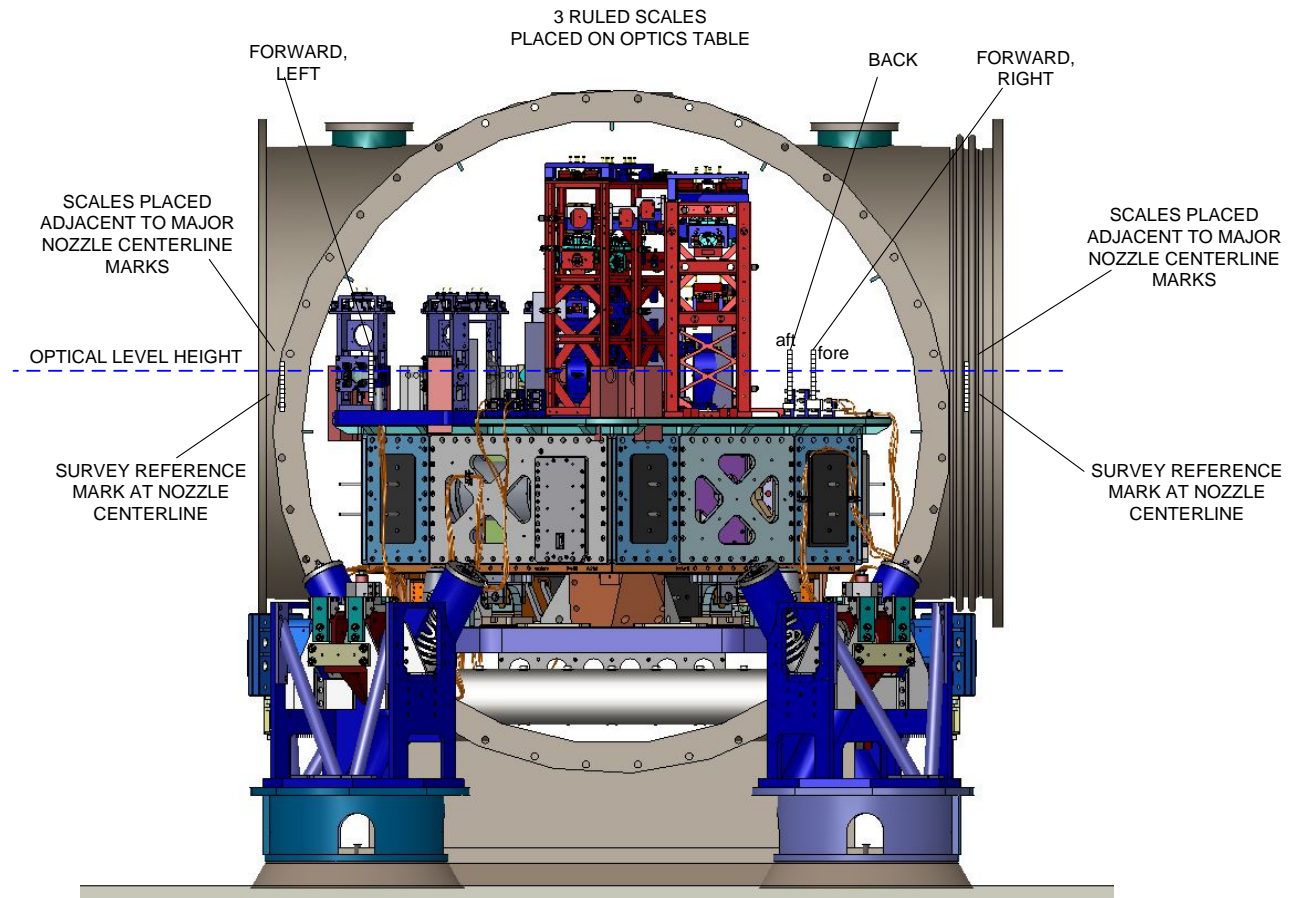

Figure 19 Setting the HAM Optics Table Height and Level

The HAM optics table is leveled and set in elevation through the use of an optical level and targets placed on the table surface, viewed through the large chamber door openings. (The WHAM2 chamber assembly is shown as an example. Note that the spacer between the support tube and the bottom of the ISI Assembly is not shown.)

The longitudinal position (e.g. y) of the optics table can be established with a retro-reflector and electronic distance measurement (EDM) with the Total Station placed along (or parallel to) the beam line axis (see Figure 14).

The optics table lateral positioning within the horizontal plane (e.g. x) is established using the cross-hair target, which is integral with the retroreflector, viewed by the Total Station along the centerline axis (see Figure 14).

The optics table yaw and lateral positioning within the horizontal plane (e.g. x) are established using targets placed on the optics table and viewed by the Total Station along (or parallel to) the beam line axis (see Figure 14). By knowing the location of the targets relative to the optics table hole pattern, the precise Total Station angle at which each target should be located is known. HEPI is used to move the table. Obviously when the table is positioned before the actual payload elements are in place (and only weights are on the table), then one can make the yaw and laterally positioning easier by placing 2 targets on the centerline and another 2 targets equally displaced laterally from the centerline.

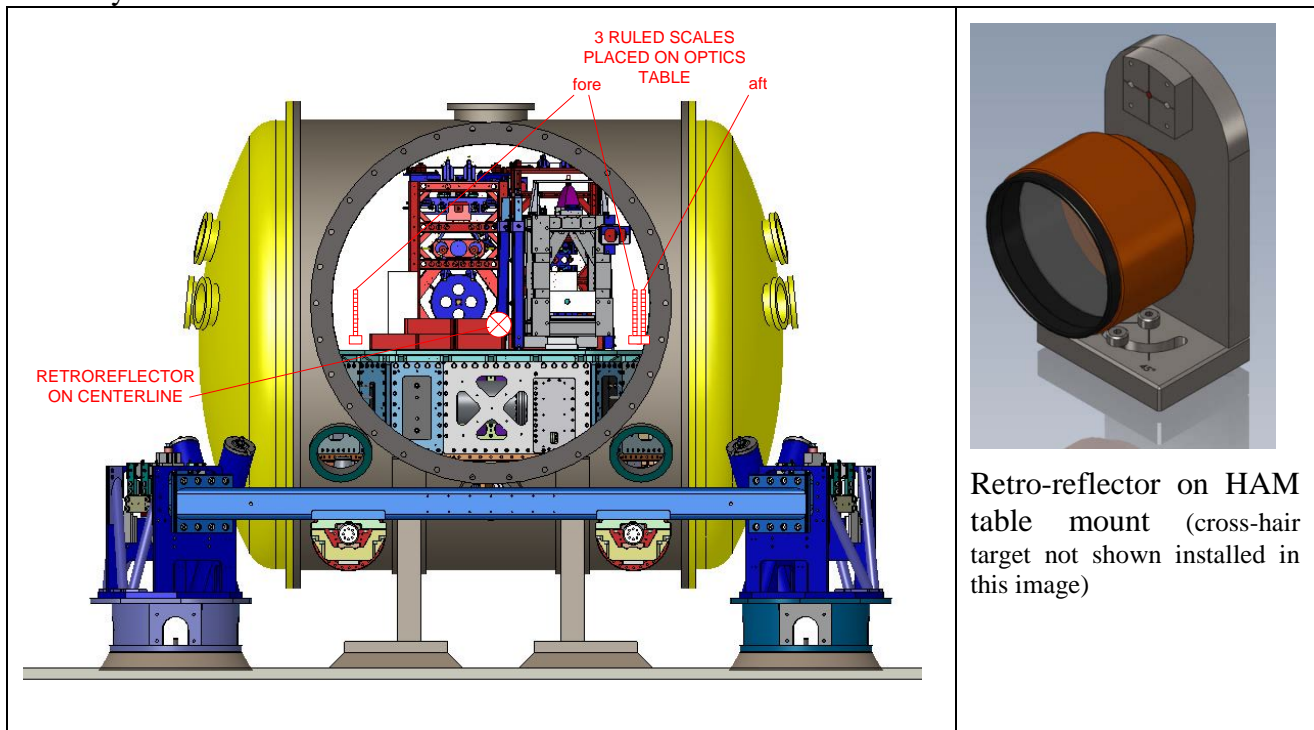
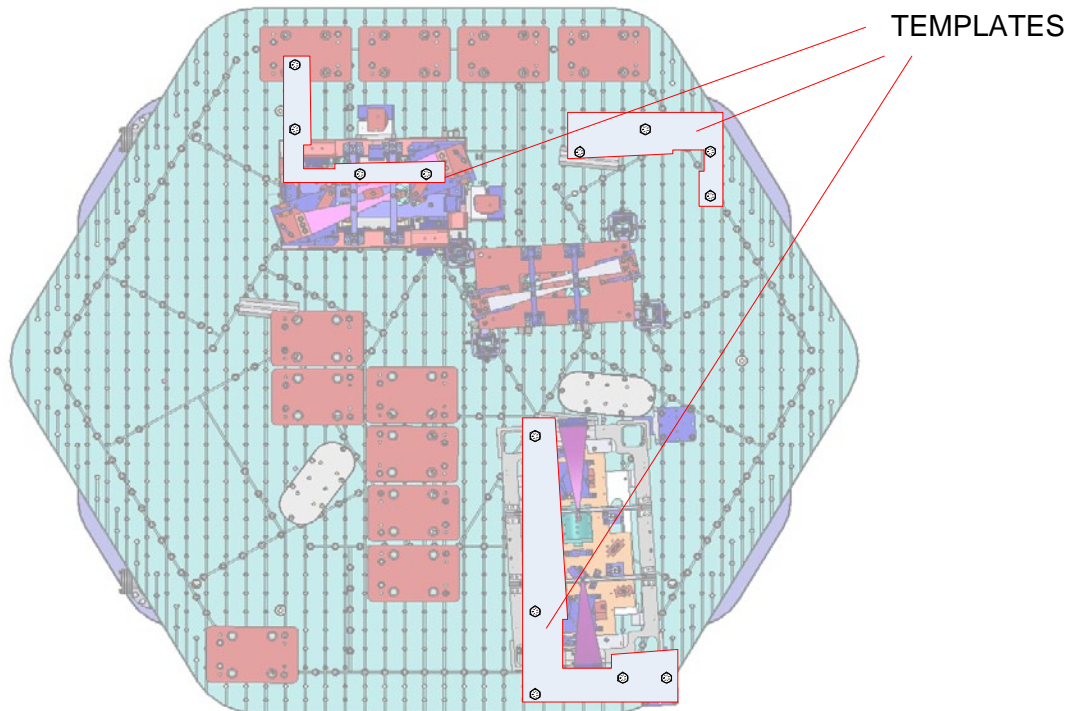

Figure 20 Setting the HAM Optics Table Yaw and Position within a Horizontal Plane (WHAM5 chamber assembly is shown as an example.)

10.1.3 Approximate Alignment with Templates

For the larger suspension assemblies, templates are installed on the optics table using appropriate tapped holes in the table surface. The optical assemblies are then placed on the table with mating surfaces at the base of the assemblies against the template. Once the optics assembly (e.g. suspension) is clamped to the optics table, the templates are removed. At this point only a couple or a few dog clamps serve to keep the approximate payload alignment (i.e. not the full complement of clamps used to rigidly attach the payload to the optics table).



**Figure 21 Example use of an Alignment Template
(approximate alignment of the SR3, SRM and OFI in HAM5)**

10.1.4 Precise Alignment

Precise alignment of primary optics is performed with a Total Station, a retro-reflector with attached target and a laser autocollimator mounted on the Total Station (see Figure 6), in the following order:

- i. Establish the optical axis: Prior to installing onto a HAM-ISI optics table, establish the optical axis with zero OSEM bias commands.
- ii. Longitudinal position: The Total Station's electronic distance measurement (EDM) capability is used with the retro-reflector assembly to establish longitudinal position.
- iii. Lateral & Vertical position: The Total Station is used to establish lateral and vertical position by sighting on the target in the retro-reflector assembly on the suspension frames.

- iv. Pitch and yaw: Pitch and yaw are established with the autocollimator. First Contact needs to be removed from the optic⁷.

A retro-reflector is mounted to the suspension frame such that the center of the aperture is precisely positioned on the optical axis, as shown in Figure 16. Prior to installing a suspension in a chamber, a coordinate measuring machine (CMM) arm is used to measure the distance of the reflecting plane of the retro-reflector from the optic front surface, as well as the vertical and horizontal distance from the center of the cross-hair target (part of the retro-reflector assembly) to the center of the optic. These measurements are accomplished by touching the CMM probe to the optic front face along its outer perimeter at several locations to establish a best fit plane⁸ to the face and along its barrel to establish a best fit cylindrical axis⁹. The location of the reflecting plane of the retro-reflector is a known constant offset distance from its mounting plane. Both the retro-reflector mounting plane and the center of the cross-hair target can be accessed by the CMM probe.

Once the retroreflector has been positioned on the cylindrical centerline, a laser autocollimator is set up in the lab to be horizontal and centered on the optic/retroreflector. The retroreflector is removed, the FristContract™ film is removed and then the height and lateral position of the autocollimator is adjusted until the pitch (vertical) and yaw (horizontal) components of the return beam is minimized. The autocollimator is now on the optical axis for the situation when the OSEMs have zero bias commands. The displacements laterally and vertically from the autocollimator initial position (cylindrical axis) to its final position (optical axis) are used to set the retroreflector position to be on the optical axis.

This technique for finding the location of the front face of a test mass (but not the optical axis), with a CMM, while suspended in a quadruple pendulum was successfully performed at LASTI. The stops were set quite close and care had to be taken so as not to disturb the optic. This approach has not yet been tried on a HSTS or HLTS, but we think it is workable.

⁷ The curvature of the optics in the HAM chambers (in the signal and power recycling cavities and the mode cleaner) prevents us from reflecting off of the edge of the optics and permitting the First Contact to remain on the central portion of the optic; The reflected beam exceeds the 2 mrad range of the autocollimator.

⁸ The maximum sagitta for any of the optics is 0.26 mm which is well within the allowable ± 3 mm axial positioning accuracy requirement, so a best fit plane is adequate.

⁹ None of the recycling cavity optics have a specification on the decentering tolerance. There are several manufacturing tolerances which can contribute to the angular and positional error between the cylindrical and optical axes. Based on the perpendicularity tolerance of the barrel to the front face called out on the drawing, the positional error in using the cylindrical axis rather than the optical axis is 0.1 mm for the ITM, ETM, and BS and 0.2 mm for the PR3 and SR3. The P(S)R2 and P(S)M optics do not have a specified barrel perpendicularity; For these optics if we assume that the angular error between the cylindrical and optical axes is equal to the wedge angle tolerance, then the positional error is 0.2 mm. In all cases these errors are well within the required positional accuracy. However these are indirect and somewhat perverse ways of specifying/determining the decentering error. In the end it is best to measure the decenter.

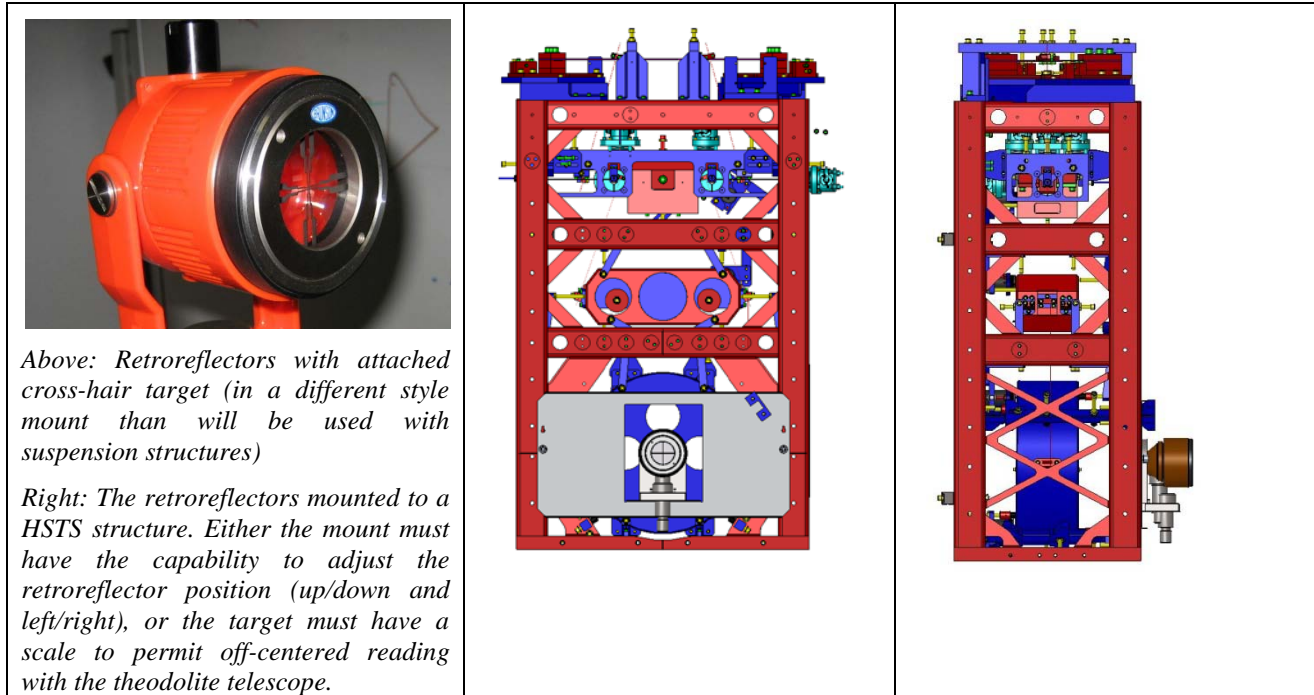

Figure 22 Retroreflector Mounted to a HSTS

The retro-reflector is attached to the front of the suspension frame (HSTS, HLTS, OMC, OFI) with a “universal” mounting plate. (The spacer under the suspension structure is not depicted in this image.)

Manual adjustment in the alignment of a suspension is accomplished by rigid body translation (x, y, yaw) of each assembly using goniometer adjusters, as depicted in

Figure 17. This manual adjustment will be sufficient to put the alignment well within the active (OSEM) yaw adjustment range (as required) and within the tolerances for lateral alignment error.

If it is necessary to adjust the height of a cardinal optic, then the HEPI static (manual) height adjustment shall be used. However, since this affects all optics on the table and the table height should already have been set properly, this should not be necessary.

Optic pitch should be within the allowable tolerance as assembled. If this is found not to be the case, then the pitch can be adjusted in accordance with the suspension assembly instructions.

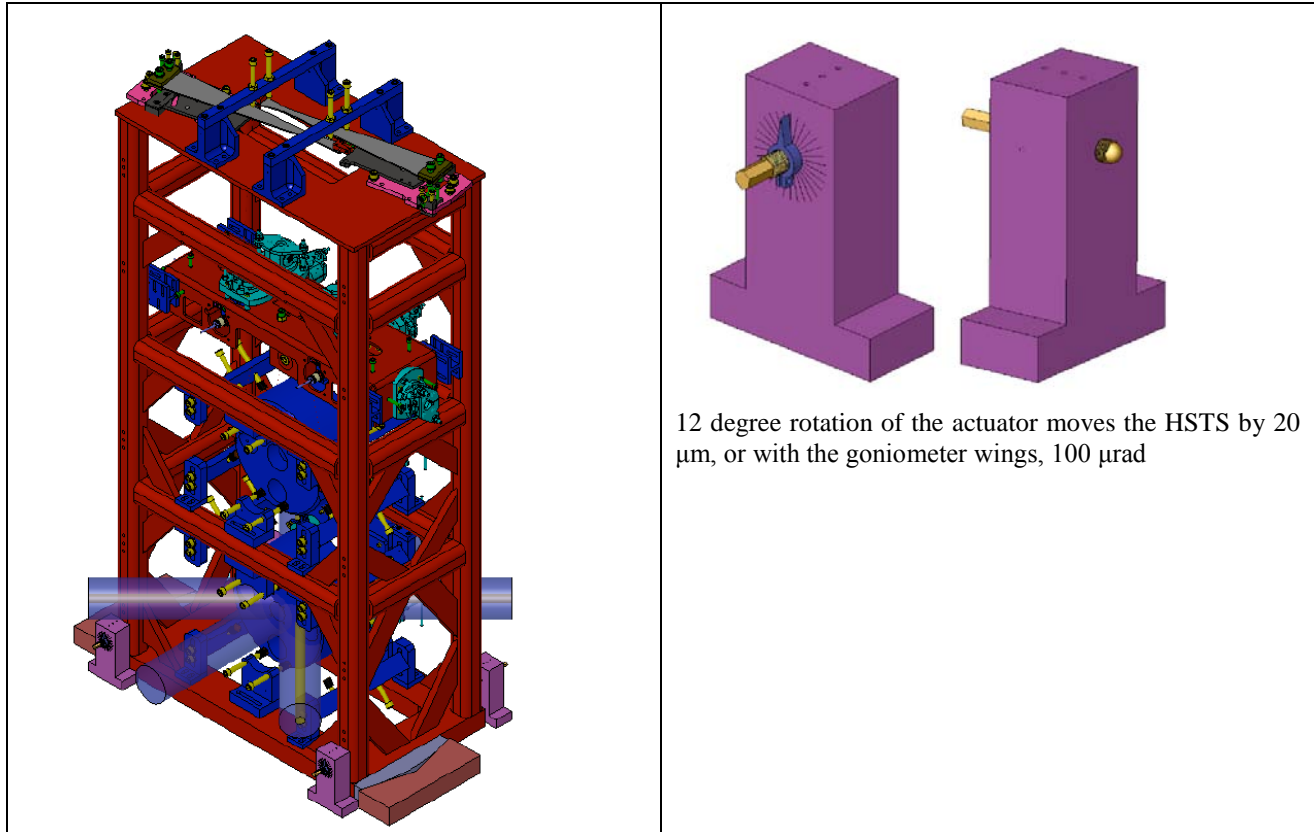

Figure 23 Suspension Frame Alignment Adjustment

From the IO FDD, HAM small triple pendulum suspensions (HSTS) will be adjusted (x, y, yaw) using manual mechanical pushers and a set of goniometer ‘wings’ added to the base (or spacer) of the suspension frame. The same approach will be used for the HLTS, the OMC and the OFI

10.2 BSC Chamber Payloads

The alignment of BSC payload elements and optics table starts as a “Cartridge Assembly” on the Mechanical Test Stand ([D080464-v3](#)). The “cartridge” is intended (as much as possible) to be the entire complement of all payload elements on a BSC seismic isolation platform¹⁰. However some payload elements cannot be inserted into the BSC chamber from above while attached to the seismic isolation system (e.g. the lower section of the Arm Cavity Baffle); These payload elements must be attached after the cartridge has been installed into the BSC chamber.

However even before the cartridge assembly, IAS supports the alignment of the test mass optic as the fused silica fibers are welded to the test mass optic during final assembly before BSC cartridge integration. The basic steps are as follows:

- 1) Support the test mass optic alignment in the quadruple pendulum assembly

¹⁰ The seismic isolation system has payload elements mounted to its optics table and the lower surface of its stage-0 structure.

- 2) Check optics table alignment on the BSC mechanical test stand
- 3) Establish the offset optical alignment axis for the Cartridge Assembly
- 4) Approximately align the Cartridge Assembly elements with templates
- 5) Co-align each optic assembly within the Cartridge Assembly (including for example beam dumps and baffles to the extent possible)
- 6) Align the Cartridge Assembly in the BSC chamber (in situ)

The basic steps are detailed in separate flow charts for the ITM and ETM:

- LIGO-T1000445: [Flow Chart AOS/IAS H1 &L1 ITMy Alignment](#)
- LIGO-T1000446: [Flow Chart AOS/IAS H1 &L1 ITMx Alignment](#)
- LIGO-T1000447: [Flow Chart AOS/IAS H1,H2 &L1 ETMs Alignment](#)

These flow charts will be fleshed out into detailed procedures, with written checklist steps. The procedures will reference the following layout drawings for these alignments:

- LIGO-D1002643: [IAS Layout for H1 ITMx](#)
- LIGO-D1002644: [IAS Layout for H1 ITMy](#)
- LIGO-D1002645: [IAS Layout for H1 BS](#)
- LIGO-D1002646: [IAS Layout for H1 ETMx](#)
- LIGO-D1002647: [IAS Layout for H1 ETMy](#)
- LIGO-D1002650: [IAS Layout for H2 FMx, ITMx](#)
- LIGO-D1002651: [IAS Layout for H2 FMy, ITMy](#)
- LIGO-D1002907: [IAS Layout for H2 BS](#)
- LIGO-D1002652: [IAS Layout for H2 ETMx](#)
- LIGO-D1002653: [IAS Layout for H2 ETMy](#)
- LIGO-D1002910: [IAS Layout for L1 ITMX](#)
- LIGO-D1002911: [IAS Layout for L1 ITMY](#)
- LIGO-D1002912: [IAS Layout for L1 BS](#)
- LIGO-D1002913: [IAS Layout for L1 ETMX](#)
- LIGO-D1002914: [IAS Layout for L1 ETMY](#)

The alignment parameters for the payloads are given in Table 5.

10.2.1 Test Mass Alignment within the quadruple pendulum assembly

Of course this step only applies to the test mass chambers and not the chambers which house the BS optic.

Synopsis of the flow chart steps here

The TM optic pitch will be affected by the First Contact™ film which will remain on the HR face until just before closing up the chamber, so as to keep the optic as clean as possible. The expected pitch error¹¹ is 0.26 mrad (HR outward normal vector pointing down) for the TM. This is a significant bias error (compared to our requirement of 0.1 mrad total error). However, this is well within the range of the visible laser autocollimator. If we never remove the First Contact™ film

¹¹ N. Robertson communication 21 May 2010, based on measurements of First Contact™ film mass (1.74 g) by M. Phelps and pitch compliance (0.154 rad/(N-m)) calculation by M. Barton.

until exiting the chamber, then what really matters is the pitch error repeatability. If we permit removal of the First Contact™ film after fiber welding for a pitch check, and then re-apply the film for the balance of the installation, there is no issue.

10.2.2 Establish an Offset Optical Alignment Axis for the Test Stand

The mechanical test stands are used to integrate all of the BSC chamber payload onto the ISI before it is installed as a “cartridge” into the chamber. The location of the test stands within each building is shown in the following drawings:

- D# pending, LHO Corner Station, SEI ISI Mechanical Test Stand Locations (in the interim for approximate location see [D1002650](#))
- D# pending, LHO End Stations, SEI ISI Mechanical Test Stand Locations (in the interim for approximate location see [D1100024](#))
- D# pending, LLO Corner Station, SEI ISI Mechanical Test Stand Locations
- D# pending, LLO End Stations, SEI ISI Mechanical Test Stand Locations

One establishes a mechanical test stand, or cartridge assembly, alignment axis parallel to the attachment axis interface and at a lateral position corresponding to the offset from center for the beam line. This mechanical test stand reference axis is then normal to the front (HR) face of a test mass. This axis is established by using struts that span across the test stand interface which mocks up the support tube interface to the SEI BSC-ISI, and then citing a reference mark on each of these struts, placed fore and aft, with a total station (theodolite) or transit. One then uses the theodolite to transfer the axis reference to marks on the floor before the cartridge assembly blocks access to the test stand attachment interface (as shown in Figure 18). The reference marks on the tooling are used to indicate the offset vertical reference planes for the optics (200 mm left and right of center). The Total Station or transit is mounted on an x-y, linear stage so that it can be translated until the reference marks on both tooling struts are in the same plane as the transit. A reference mark (monument) is then made on the floor directly beneath the transit. In general the floor reference marks (monuments) should be created for both the left and right offset optical planes.

Elevation reference scribe marks are made on the test stand structure at a distance of 54.016 in (1372 mm) below the attachment interface plane for the BSC-ISI. This elevation corresponds to the center of the test mass optic (ITM & ETM). A scale is also mounted to the test stand structure next to these scribe marks so that the elevation of other optical assemblies (e.g. the BS) can be determined.

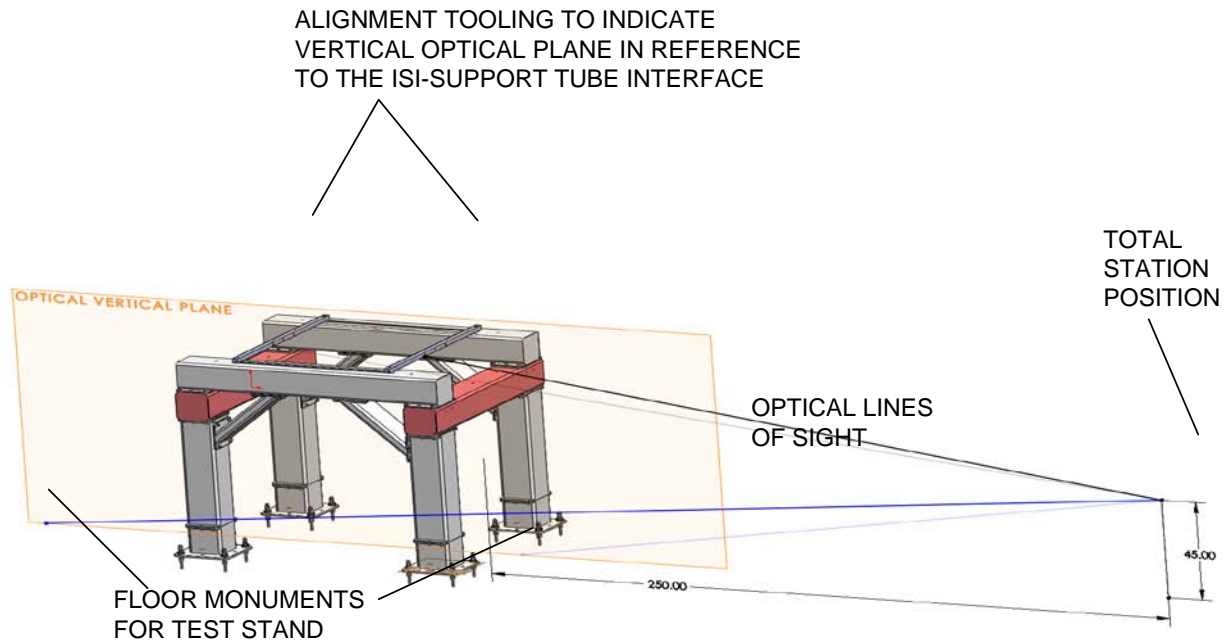

Figure 24 Determining the optical alignment references for the Mechanical Test Stand

10.2.3 Optics Table Alignment on the Test Stand

The mechanical test stand does not have the capability to adjust height once grouted to the floor. The BSC-ISI optics table height likewise cannot be adjusted when on the test stand, except by adjusting balance/ballast mass. The appropriate height measurement is the distance from the optics table to the interface plane between the HAM-ISI assembly and the test stand (i.e. the ersatz support tubes). The separation between the optics table and the support tube interface is likely to have a tolerance on the order of ± 4 mm due to manufacturing and assembly tolerances. It is not important to attempt to zero this tolerance error by ‘dummy’ mass adjustment since the optical payload masses have yet to be integrated onto the table. However, the separation distance should be measured to ensure that it is not far from expected. One potentially convenient (and only slightly indirect) means to measure this separation distance is to measure the gap between the stage-0 structure and the optics table (see Figure 19).

By measuring the gap between stage-0 and the optics table around the perimeter of the table one can also get a rough measure of the levelness of the table since the test stand is leveled when grouted in place. It not necessary to adjust the table levelness at this point since the optical payload masses have yet to be integrated onto the table.

The BSC-ISI system does not have the capability to (readily) adjust yaw and horizontal plane positioning (x, y) while on the test stand. Once installed in the BSC chamber, the HEPI static positioning capability can be used to adjust all six rigid body degrees of freedom of the optics table.

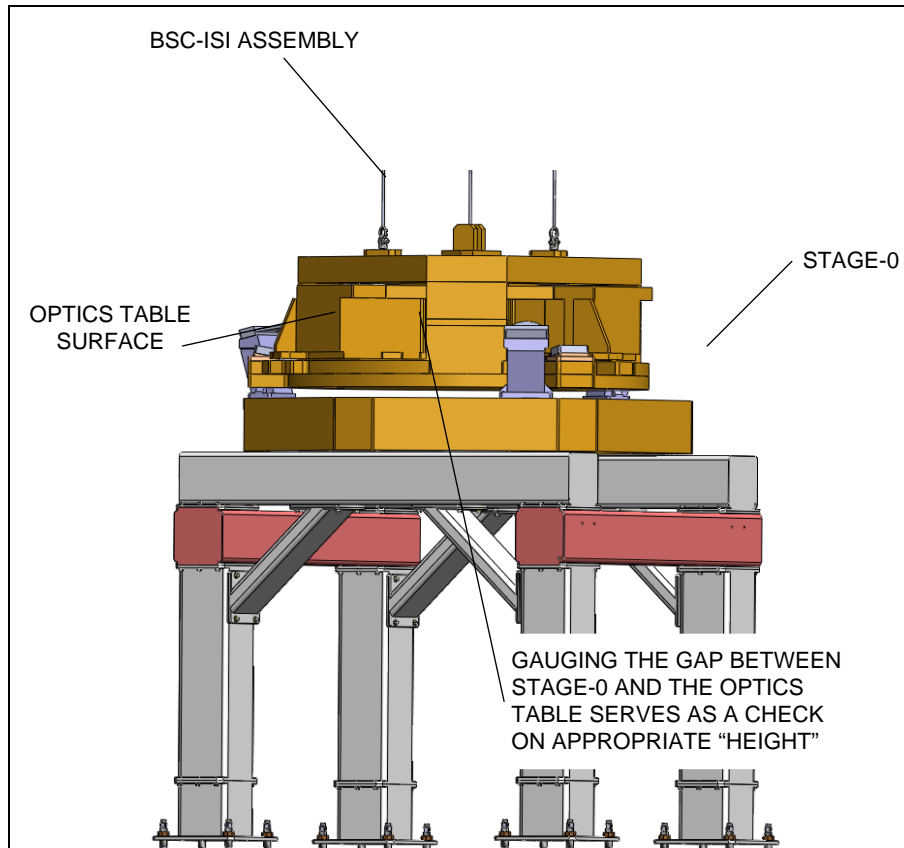

Figure 25 Checking the BSC Optics Table Height

10.2.4 Approximate Template Alignment

For each payload assembly, a template is mounted on the optics table using appropriate tapped holes in the table (or stage-0) surface (just as in the case of the HAM suspensions). The optical assemblies are then placed on the table with mating surfaces at the top of the assemblies against the template. Once the payload element (e.g. suspension) is clamped to the optics table, the templates are removed.

10.2.5 Co-Alignment of the Cartridge Assembly Elements

Ideally once a cardinal optic has been aligned on the optics table in the cartridge assembly, the other optical elements are aligned to this cardinal optic. In other words the cartridge optical elements are all co-aligned to one another. Then the entire cartridge assembly can be aligned within the BSC chamber by rigid body translation/rotation using the HEPI system. The cardinal optics for the input and end test mass chambers are the test mass optics of course. The beam splitter (BS) is the cardinal optic for the central BSC chambers. Ideally the alignment for all optical elements in a cartridge is derived from the alignment of the cardinal optic.

10.2.5.1 Optics Table Height and Level

Once the entire payload has been installed into the cartridge assembly and make-up and balance mass has been installed, the BSC-ISI optics table height (relative to the support tube interface) and levelness must be checked and adjusted.

An optical level will be used to level the table using targets mounted to the optics table. Four targets mounted at the left, right, fore and aft edges of the table will be used to guide the table level (roll & pitch) using the BSC-ISI balancing capability.

10.2.5.2 Precision Alignment of the Primary Optics

Precise alignment of primary optics is performed with a Total Station, a retro-reflector with attached target and a laser autocollimator mounted on the Total Station in the following order:

- i. Longitudinal position: The Total Station's electronic distance measurement (EDM) capability is used with the retroreflector assembly to establish longitudinal position.
- ii. Lateral & Vertical position: The Total Station is used to establish lateral and vertical position by sighting on the target in the retroreflector assembly on the suspension frames.
- iii. Pitch and yaw: Pitch and yaw are established with the autocollimator. First Contact needs to be removed from the optic. In the case of the test mass optics, the autocollimator periscope is not used and only a small patch of First Contact™ is removed at the 12 o'clock position. A small correction needs to be included to account for the radius of curvature of the optic.

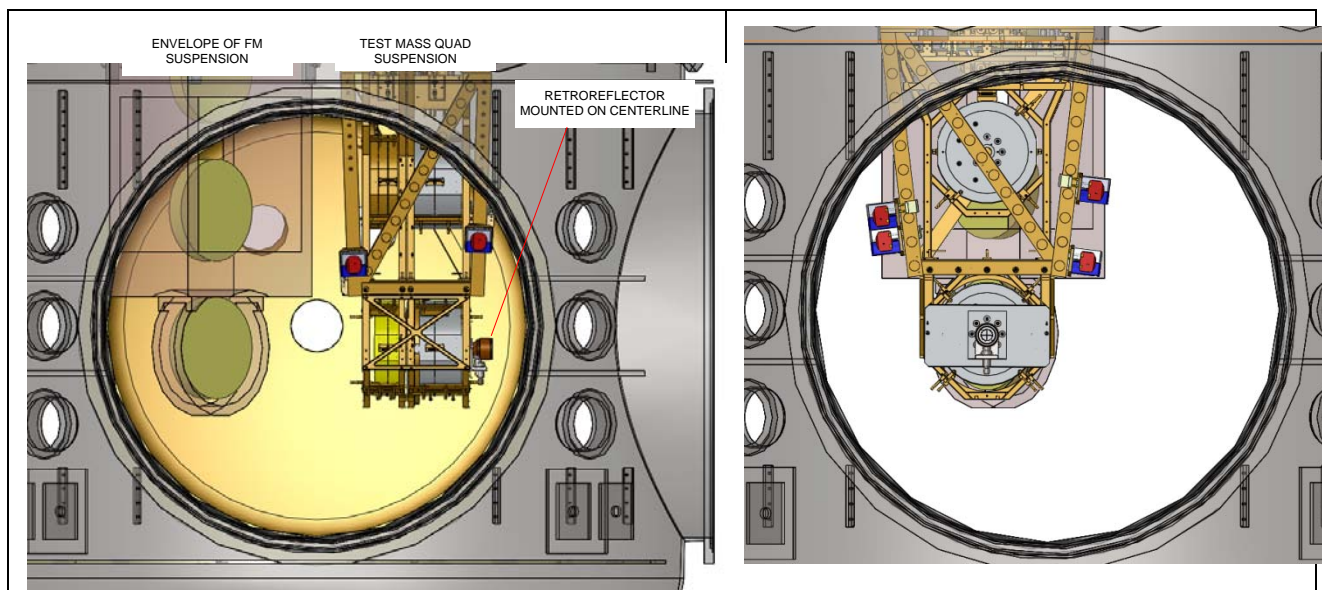

Figure 26 Retroreflector mounted to a ITM Suspension

Manual adjustment in the alignment of a suspension is accomplished in two steps. First one does coarse adjustment by rigid body translation (x, y, yaw) of each assembly. Next precision yaw adjustment is accomplished by adjusting the orientation of the top springs. Experience at LASTI indicates that moving the suspension structure has a precision of about 1 mrad. In order to achieve our required accuracy of 0.1 mrad or less, it will be necessary to adjust the suspension springs using the suspension adjustment procedures.

Four potential approaches to translating/yawing the BSC-ISI payloads are considered:

- a) Simply loosen the dog clamps and use pusher tools ([D060052](#); see Figure 21; similar to those described in section 10.1.4) – which was the method employed at LASTI.
- b) Mount temporary low friction bearing blocks ([D060053](#)) around the perimeter of the suspension structure interface to the optics table and lower the suspension onto these blocks by loosening the dog clamps, and use pusher tools. This would make the adjustment easier to accomplish and perhaps give a little better precision, but with the slight added risk of dropping components from above the optic. It may also shed less particulates than option a).
- c) Design a means to secure goniometer adjusters (as described in section 10.1.4) to the upper structure of the TM and BS/FM suspensions and then use pusher tools either in conjunction with the low friction bearing blocks or not. This allows the yaw motion to be accomplished separately from the translation (diagonalizes the motion).
- d) Use the 5-axis fixture mounted to the lift cart ([T1000341](#)) and an interface fixture which permits the entire TM, or BS/FM, suspension to be supported. A prototype interface fixture to lift the TM suspension has been built but has not yet been tested. An interface for the BS/FM suspension would need to be designed and tested.

Our preferred approach is a), but we will explore b) and d) as options or alternatives.

The optic pitch should be within the allowable tolerance as assembled. If this is found not to be the case, then the pitch can be adjusted in accordance with the suspension assembly instructions.



Figure 27 Pusher used to adjust the quad suspension position at LASTI

10.2.5.3 Co-alignment

10.2.5.3.1 FM

The H2 BSC chambers with ITMs also have the FM optics (WBSC7 and WBSC8). First the ITM HR face is aligned with the Total Station and visible laser autocollimator (Figure 22). Then the IR laser autocollimator is set perpendicular to the ITM HR face (by autocollimation). The IR laser autocollimator is then used to project a reticule pattern to the FM where centering can be checked against a target. The projected beam can then be permitted to propagate to the flat mirror and then retroreflected back to the autocollimator. The yaw angle of the FM is then adjusted to zero the yaw angle error as observed on the IR camera attached to the IR laser autocollimator. The pitch angle should be correct since it was set during assembly, but if necessary the pitch can also be adjusted per the suspension pitch adjustment procedure.

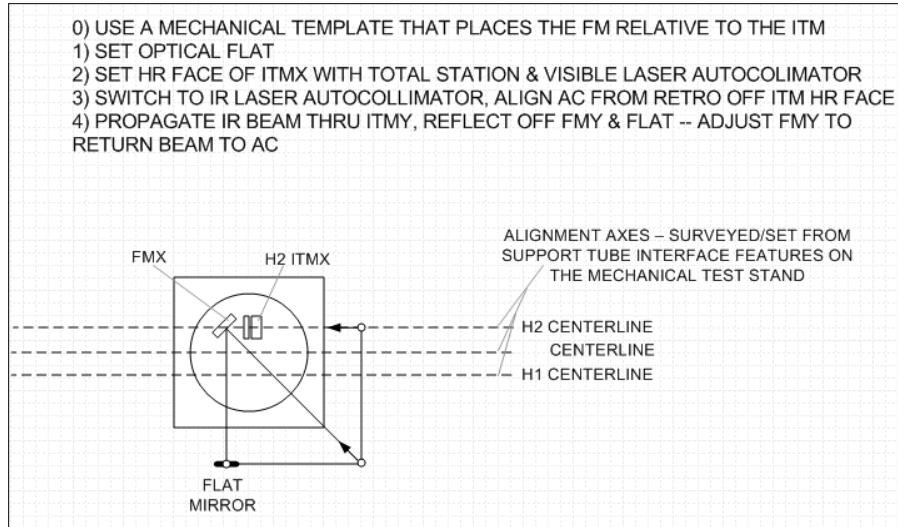

Figure 28 Alignment of the FM on the Test Stand

Once the FM is aligned, the alignment of the two FM beam dumps and the FM scraper beam dump can be checked with targets and sensitive IR cameras such as the Watec WAT-902H (Figure 23).

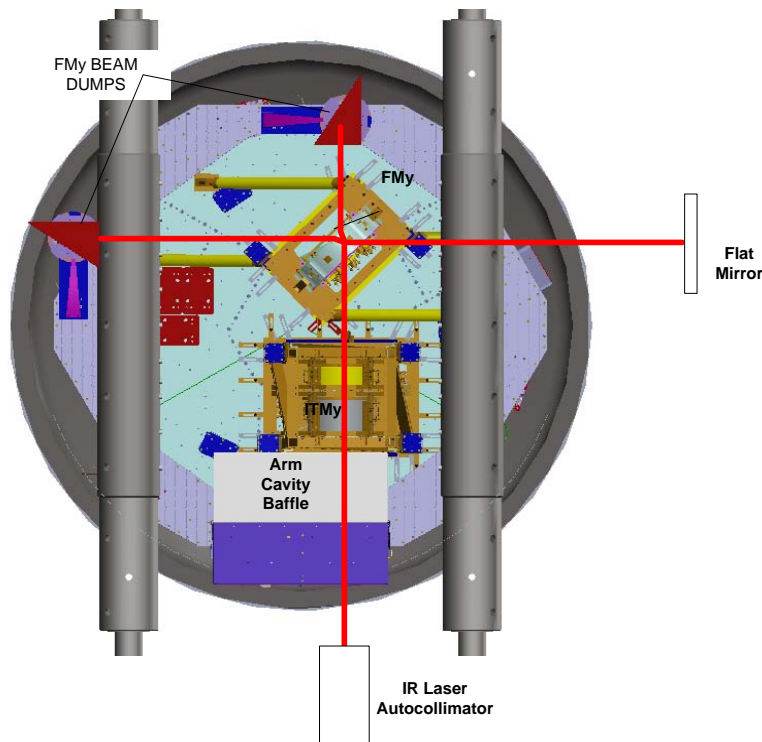

Figure 29 Alignment of the FM chamber beam dumps

10.2.5.3.2 TMS

In addition to the ETM suspension, each ETM chamber contains a TMS assembly (Figure 24). First the ETM HR face is aligned with the Total Station and visible laser autocollimator. Then the IR laser autocollimator is set perpendicular to the ETM HR face (by autocollimation). The IR laser autocollimator is then used to project into the TMS. The beam propagates through the pre-aligned

TMS assembly to its quad detectors. Centering of the TMS aperture can be checked with a target. Yaw (and if needed pitch) are adjusted to center the beam on the quad detectors.

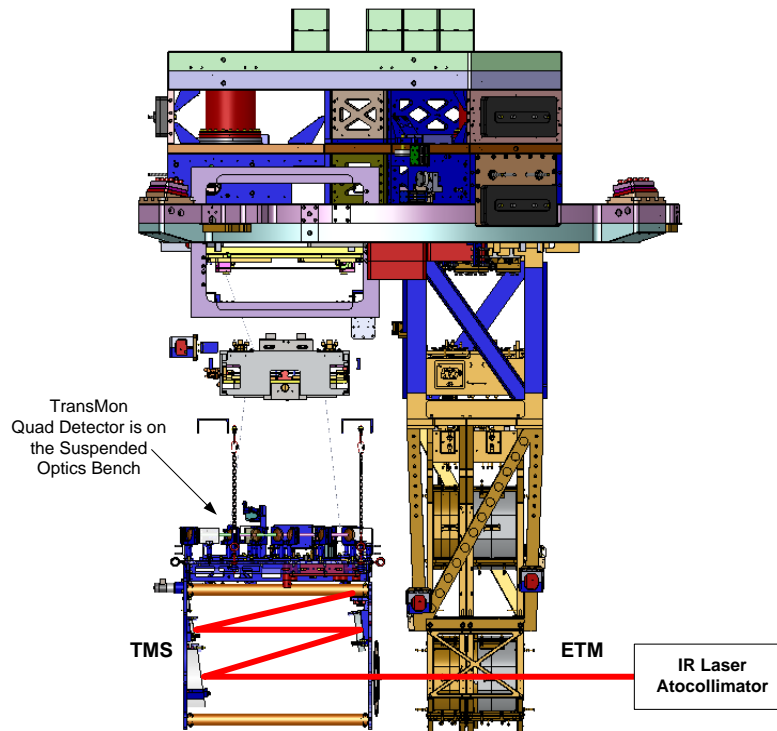

Figure 30 Alignment of the TMS

10.2.6 Establish an Offset Optical Alignment Axis for the Chamber

In general one establishes an alignment axis by picking up a parallel axis from some nearby alignment monuments and laterally transferring this axis using an optical square and a theodolite (or total station), as depicted in Figure 25 for the H1 ITMx optic, or more precisely the WBSC3 “cartridge” which has the H1 ITMx optic as its cardinal primary optic. For this particular example, the Brunson optical transit square is placed directly above monument IAM88¹². The height of the optical transit square must be set (approximately) to the intended height of the total station, since the total station will retro-reflect off of the transit square optic. The elevation reference scribe marks on, or near, the horizontal vacuum equipment centerline at the flanges, are used. If a line of sight to these elevation references is not available, then they are transferred to the wall in the vicinity of the Total Station.

For the H1 ITMx example (Figure 25) the Total Station is placed over a monument under the spool next to the large gate valve, which is located 200 mm (7.874 inch) from the global axis (beam tube) centerline (monument TBD). The Total Station height is set to be on the H1 arm optical axis (-80

¹² IAM88 is one of the derived monuments noted in section 6. We think that this monument is located at an appropriate location, but need to check through iLIGO alignment notes to confirm. If this is not at an appropriate location, then another monument will be surveyed into position.

mm from the global axis). The Total Station is then turned 90.0 degrees and pitched so that it is pointing along the arm cavity axis (in this case pointing up 619.5 microradians).

It is important to sight a distant monument with the optical transit square in order to get an accurate angular reference; this is especially important for the test mass optic alignment. (See section 17 for a discussion of the error budget.) In this example for the H1 ITMx, the optical transit square cites IAM3 which is located ~575 ft (175 m) from the transit square.

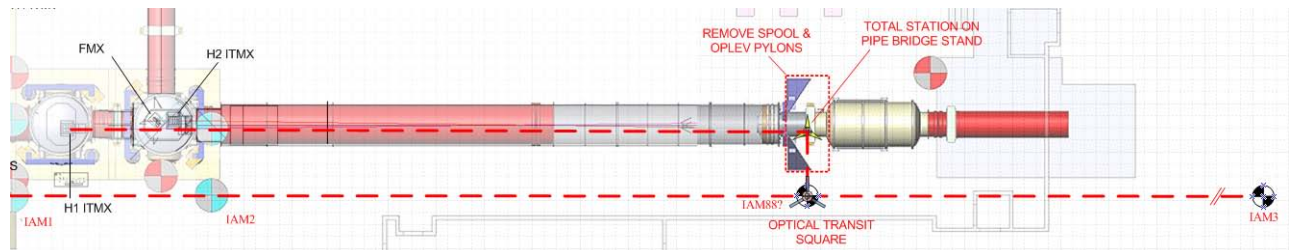

Figure 31 Establishing the Optical Alignment Axis for H1 ITMx

10.2.7 Align the Cartridge within the Chamber

The HEPI static positioning capability (using the 8 offload spring adjustments) will be used to set the table to be level (pitch and tilt) and at the proper elevation. The tolerances of the BSC-ISI assembly result in an uncertainty in location and orientation of the BSC optics table, relative to the support tube interface of at least as much as for the HAM optics table since the BSC-ISI is comprised of two stages whereas the HAM-ISI is comprised of one. Consequently we can expect errors of at least ± 0.087 in laterally (± 2 mm), ± 1.7 mrad yaw and ± 0.4 mrad pitch and tilt. In addition to this tolerance stackup error, there is even greater uncertainty in the positioning of the support tubes.

An optical level will be used to sight the height of targets, which are mounted on posts attached to the table, relative to the scribe lines on the chamber flanges using scales mounted vertically to the flanges (as depicted in Figure 26). Four targets mounted at the left, right, fore and aft edges of the table will be used to guide the table level (roll & pitch) and to the proper height (z) using the static positioning capability of the HEPI system. 0

Once the table is level and at the correct elevation, the EDM capability of the Total Station is used (with a retroreflector which has been mounted to the suspension structure at the optic centerline) to determine the longitudinal distance to the optic HR face. The Total Station is also used to site the target attached to the retroreflector. Since the visible laser autocollimator can view the perimeter of the BSC chamber optics while the Total Station is aligned to the optic center, the pitch and yaw can be monitored at the same time. Then the HEPI static adjustment capability is used (if needed) to zero vertical and lateral position errors, to set the proper longitudinal position and to zero the yaw error. The pitch of the optic should be correct; there should be no need to adjust the optic pitch.

Experience at LASTI suggests that removal of the First Contact™ film should not alter the alignment. We do not plan to do any final alignment checks with the Total Station and visible laser autocollimator after the First Contact™ has been removed.

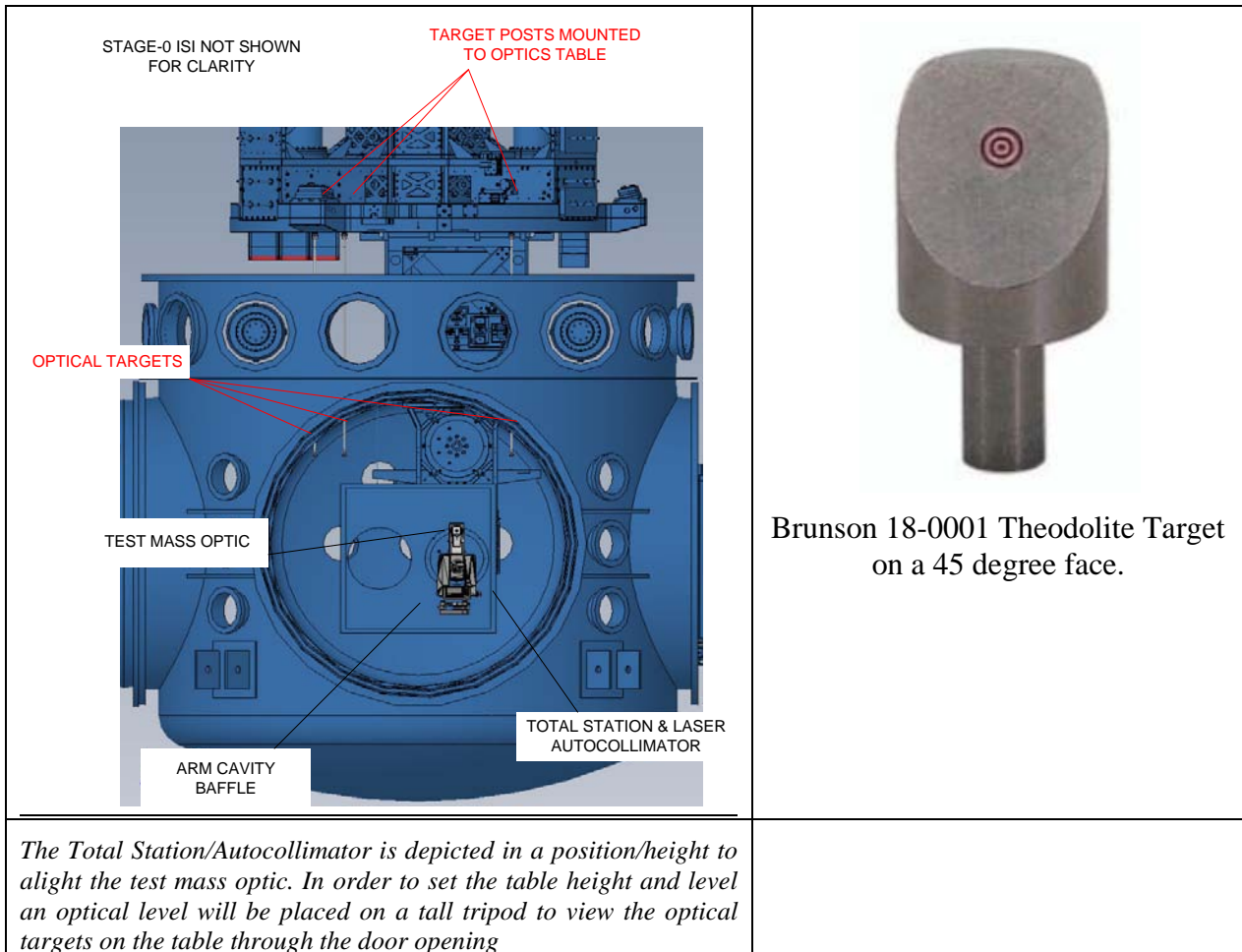

Figure 32 Setting the BSC Optics Table Height and Level in the Chamber

11 Alignment Check

After positioning and aligning each individual optic separately, an integrated alignment is checked, and if needed, optics are adjusted. These checks are planned for the following sets of optics:

- power recycling cavity (PRC) optics (PR3, PR2, PRM)
- signal recycling cavity (SRC) optics (PR3, PR2, PRM)
- short Michelson interferometer (SMI) optics (ITM_x, ITM_y, BS, PR3, PR2, PRM)

The test is accomplished with either the red beam of the Total Station (Sokkia SetX1) or the IR laser autocollimator. The Total Station has better accuracy but may not have sufficient power to propagate through all of the optics.

The alignment of the PRC is illustrated in Figure 27 (where the alignment source is placed at position 4). In order to retain the alignment for use in checking the co-alignment of the injected PSL/IO beam, two irises are planned, as shown in Figure 27. The base mount of the iris would be left in the vacuum system. The iris (or pin hole) is placed when needed. When aligning with IAS equipment in retroreflection from the PRM, the alignment/pointing beam can then be observed on both sides of the iris.

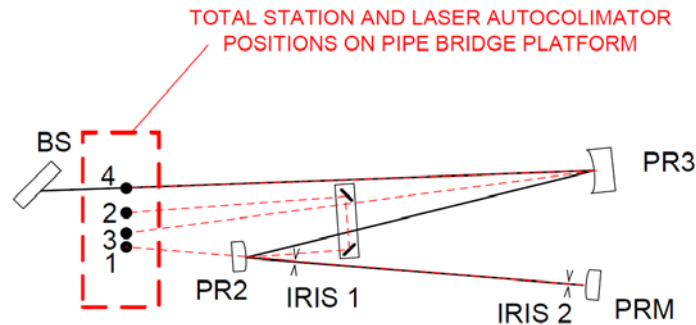

Figure 33 Alignment check of the PRC Optics

12 Alignment Sequence

12.1 Alignment Sequence Constraints

New alignment monuments must be surveyed onto the floor at LHO. This work must be done before all other alignment tasks.

The recycling cavity septum plates must not be installed prior to alignment of the recycling cavity optics.

The power recycling optics (PR3, PR2, PRM) must be aligned as a set after each is individually aligned. This is referred to as aligning the Power Recycling Cavity (PRC).

Similarly The signal recycling optics (SR3, SR2, SRM) must be aligned as a set after each is individually aligned. This is referred to as aligning the Signal Recycling Cavity (SRC).

Alignment of the primary optics on an optics table should only occur after all payload elements have been installed and rough aligned on the table. Otherwise the alignment work is at risk and may need to be repeated.

The alignment of the Short Michelson Interferometer (SMI) must be checked after all of the corner station primary optics have been individually aligned.

The lines-of-sight must be kept clear of equipment such as optical lever pylons, electronics racks, etc. when the IAS alignments are performed. (These lines of sight do not have to be kept permanently clear.) The possible interferences are depicted in Figure 34:

- Along the H1/L1 X-arm baseline: the TCS H1-R1 electronics rack, the H1-TCSX optics table (may be low enough not to interfere), the cross-over stairs/platform and the test mass optical lever pylon.
- Along the H1/L1 Y-arm baseline: the TCS H1-R2 electronics rack, the H1-TCSY optics table (may be low enough not to interfere) and the test mass optical lever pylon.
- Along the H2 X-axis baseline: the PR3 optical lever pylon, the IOHT8R optics table/enclosure and the H2 PSL enclosure (do we go through the PSL enclosure to get a longer baseline?)
- Along the H2 Y-axis baseline: the TCSHT10 table and enclosure, and the SUS H2-R3 and TCS H2-R3 electronics racks

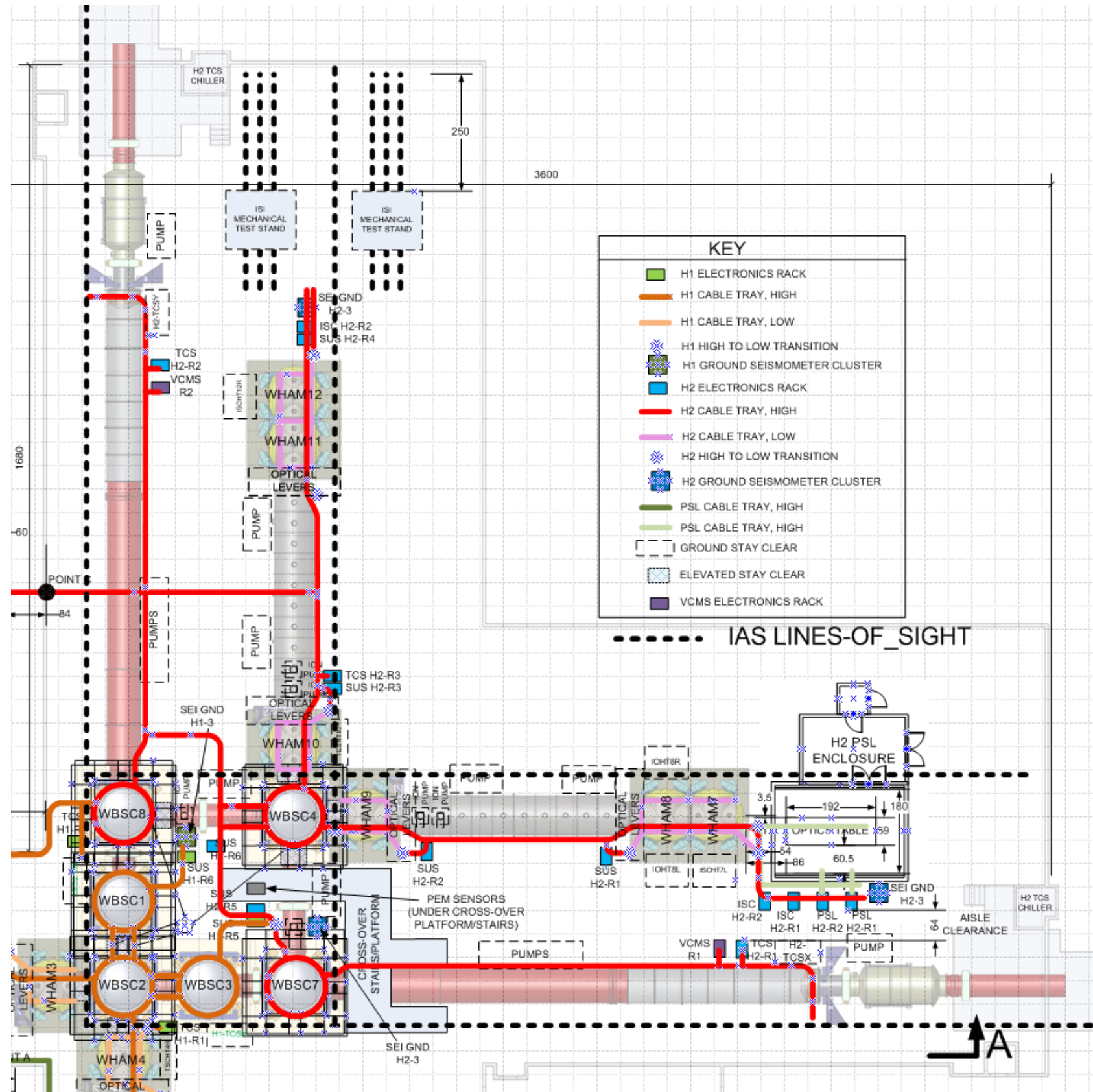

Figure 34: Possible interferences with IAS LinesOf-Sight

12.2 Planned Sequence

The initial alignment will support the planned installation sequence (see [G1000061](#) and [G1000013](#) for LHO and LLO respectively). This sequence is currently planned as indicated in Table 7. In addition to the individual primary optic alignments indicated in the sequence in Table 7, we need to plan for alignment checks of the PRC, SRC and SMI. The logical placed in the sequence for these alignment checks are also indicated in Table 7.

Table 6 Currently Planned Installation and Alignment Sequence

Site	Sequence	IFO	Optic(s)
LHO	1	H2	ITMY
	2	H2	ETMY
	3	H2	PR2
	4	H2	PR3, PRM
		H2	PRC
	5	H2	SR2
	6	H2	SR3,SRM
		H2	SRC
	7	H2	BS
	8	H2	FMX, ITMX
		H2	SMI
	9	H1	PR3, PRM
	10	H1	PR2
		H1	PRC
	11	H1	SRM, SR2, SR3
		H1	SRC
	12	H2	ETMX
13	H1	ETMX	
14	H1	ETMY	
15	H1	ITMY	
16	H1	BS	
17	H1	ITMX	
	H1	SMI	
LLO	1	L1	PR3, PRM
	2	L1	PR2
		L1	PRC
	3	L1	SR2
	4	L1	SR3, SRM
		L1	SRC
	5	L1	BS
	6	L1	ITMX
7	L1	ITMY	
	L1	SMI	

13 Other alignment notes

13.1 Reflective Targets

Reflective tape targets may give sufficient accuracy with far less weight than the retro-reflector assembly. Near term testing will establish if this is a feasible approach or not.

13.2 Temporary Recycling Cavity Septum Plates

In addition to the permanent septum plates between chambers HAM1/HAM2, HAM5/6, HAM7/8 and HAM11/12, there will be temporary septum plates between HAM3/BSC2 and HAM9/BSC4. These septa serve to isolate the input optics (mode cleaner and power recycling optics) from the corner station BSC chambers. This permits integrated test work to proceed on the input optics while installation continued in the BSC chambers and the signal recycling cavity chambers. IAS requested that a viewport be placed along the main beamline ([D1003343](#), [D1003344](#)) to serve as a possible target location to check and adjust the IO alignment in advance of installing the balance of the corner station optics.

14 Safety

The Systems group is working with the suspensions group to put into place means for protecting the optic during work on the suspensions such as alignment adjustment. These measures include a shelf to catch fasteners or tools that may be dropped from above the optic, a lens cap for the optic and possibly a shroud around the optic to minimize particulate contamination. These safeguards will be used by IAS to protect the optics from damage during alignment.

A hazard analysis report will be prepared. At this time the only identified hazard for IAS is eye safety when the IR laser autocollimator is used. A Standard Operation Procedure will be prepared for its use in each setup and at each observatory.

15 Cleanliness

All primary optics (and quite likely many secondary or auxiliary optics) shall have First Contact on the HR surface for as long and as often as possible.

When using a laser autocollimator to sense the yaw and pitch errors by reflecting directly off of the optic surface (at either 670 nm or 940 nm), either we remove the first contact from the optic or an area of the optic near the edge and perform the auto-collimation off center. An off-center approach works for the flat or nearly flat optics (FM, BS, ETM, ITM), but not for the short focal length optics (PR3, PR2, PRM, SR3, SR2 and SRM).

During alignment the purge air flow must be stopped (or severely restricted) to prevent the suspended optics from being buffeted. In this condition, particles which are shed from occupants in the chamber are not convected away. We can minimize the impact for the BSC chamber payloads because the alignment adjustment should be entirely from HEPI (x, y, z, yaw) and the suspension (active pitch bias with the OSEMs).

16 Interface Requirements

The pitch angle of each suspended optic is set properly on an optics bench before being declared ready for installation into a chamber. This is important because it is difficult to adjust the pitch of a

suspended optic in situ. The pitch error should be well within (say ~10%) of the OSEM actuation range.

section 1.1.6.1.1 “Alignment Reference Features” of the [ICD: SUS/UK – AOS, E050169-01](#)

[M050175-01.pdf](#), Initial Alignment Requirements on COC Coating Reflectivity

The HLTS and HSTS drawings have interface provisions (holes) for mounting a retroreflector and goniometers for yaw adjustment.

17 Alignment Error Budget

17.1 Yaw

Our requirement for angular alignment is 10% of the adjustment range of each suspended optic, or ± 0.1 mrad for the smallest range optic (HLTS in yaw) and ± 0.16 mrad for the test mass optics; However, over a 4 km arm length, a ± 0.16 mrad angle will bring us within 640mm to the center of our ETM, which is larger than the 1 meter diameter aperture in the beam tubes. The positional uncertainty of our reference monuments over a ~200 meter separation results in an error of up to .03 mrad. The total error accumulation including monument locations, procedural and equipment errors, is ± 0.08 mrad as shown in Table 8. At 4 km, a 0.09 mrad error brings us within 360 mm of the ETM center and within the beam tube aperture (though still outside of the arm cavity baffle aperture).

Table 7 Total Yaw Angular Error Accumulation

Error Source	Angular Error (mrad)
Positioning of monuments	.03
Sighting of plumb markers	.02
90 degree autocollimation	.01
90 degree rotation	.01
Autocollimation of optic	.01
Suspension adjustment accuracy in zeroing	.01
Total – worst case (addition)	.09
Total – rss	.04

17.2 Pitch

The Sokkia Total Station has a leveling accuracy of 20 arcsec (97 microrad). In order to get a more accurate level (zero reference for pitch), one could use the Brunson 194-TM coincidence level, which is part of the Brunson 75-H transit square, and has a sensitivity of 1 arcsec (5 microrad). The transit square, optical flat is adjusted so that it is normal to the azimuth bearing to close to the accuracy of the Newport LDS1000 laser autocollimator (say ~2 microrad).The transit square

azimuth bearing may have some bias error with respect to the level (say ~5 microrad). The Sokkia has an accuracy of 1 arcsec (5 microrad). Consequently the total error in pitch, if the pitch is derived from the Brunson750H transit square, is ~14 microrad (Table 9).

Table 8 Total Pitch Angular Error Accumulation

Error Source	Angular Error (microrad)
Brunson 194-TM coincidence level	5
Brunson 75-H optical flat runout	2
Brunson 75-H azimuth perpendicularity	5
Sokkia autocollimation	1
Sokkia pitch adjust accuracy	1
Suspension adjustment accuracy in zeroing	10
Total – worst case (addition)	24
Total – rss	12

18 Final Design Review Checklist

Each of the items in the final design review checklist from M050220, are listed below with a response:

- 1) Final requirements – any changes or refinements from *iLIGO*
See sections 5 and 7.
- 2) Resolutions of action items from PDR
Not applicable. (Since the IAS is similar to iLIGO there was no PDR)
- 3) Subsystem block and functional diagrams
Not applicable.
- 4) Drawing package (assembly drawings and majority of remaining drawings)
The custom parts are listed in [E1000827](#) and the drawings are linked as related documents on the DCC entry page for this final design document.
- 5) Final parts lists
The commercial off the shelf and custom parts are listed in [E1000827](#). See also section 8.
- 6) Final specifications
There are no stand-alone specifications. Specified commercial instruments have been identified (see section 8)
- 7) Final interface control documents
See section 16.
- 8) Relevant RODA changes and actions completed
One RODA involves IAS: [M050175-01.pdf](#) , Initial Alignment Requirements on COC Coating Reflectivity. This RODA requested COC to provide coatings (either AR or HR)

with reflectivity of 5% or greater at 670 nm for IAS and Optical Levers. As shown in section 9.3, the minimum reflectivity is 4.7%, essentially meeting the request.

9) Signed Hazard Analysis

A Hazard Analysis report is pending. See section 14

10) Final Failure Modes and Effects Analysis

No longer required.

11) Risk Registry items discussed

None applicable to IAS.

12) Design analysis and engineering test data

In an effort to improve the field of view and sensitivity of the visible laser autocollimator, a custom unit was designed, built and tested. Although it functioned, it had a rather limited linear range. Better optics and more work would have been required to provide a system which is better than the Newport LDS100, so this effort was abandoned.

All other design analysis and engineering test data is included in the sections of this document.

13) Software detailed design

Not applicable.

14) Final approach to safety and use issues

See section 14

15) Production plans

The custom machined parts needed for IAS will be competitively quoted from local machine shops. Currently first article periscope units are in fabrication.

16) Plans for acquisition of parts, components, materials needed for fabrication

Procurement has begun for the somewhat long lead instruments (Total Station SetX1 and more Newport LDS1000 autocollimators). This will give us time to fit the autocollimators to the Total Stations and to try the Total Station red pointing beam feature. See justification for early procurement in [M1100015](#)-v1.

17) Installation plans and procedures

IAS will support the installation plans developed by the INS group and defined in [G1000013](#) (LLO) and [G1000061](#) (LHO). See also section 12.

Detailed written step by step procedures will be written in advanced of each chamber installation; see section 12.

18) Final hardware test plans

Not applicable per se. It is worth noting that the alignment instruments are calibrated (the iLIGO units have been refurbished and re-calibrated recently). It is also worth noting that the use of the IR laser autocollimator serves as a “end-to-end” check of the ab initio alignments of each optic separately; see section 11.

19) Final software test plans

Not applicable.

20) Cost compatibility with cost book

The original cost book amount for the IAS portion of AOS was \$62.4K with \$10.4K contingency. The revised budget for IAS is ~\$100K. The rough estimate of cost for the current IAS plan is ~\$160K. A change request will be pursued.

21) Fabrication, installation and test schedule

The (somewhat) long lead additional instruments (Total Stations and laser autocollimators) are being ordered and will be delivered in 6 weeks.

Fabrication of the custom periscope for the visible laser autocollimator should be completed in a few weeks.

The retroreflectors universal mount design should be completed in ~3 weeks for then fabricated in ~3 weeks.

IAS supports the INS schedule defined in [G1000013](#) (LLO) and [G1000061](#) (LHO). See also section 12.

22) Lessons learned documented, circulated

See section 7

23) Problems and concerns

a) Maintaining cleanliness during alignment is a continuing concern. Procedures will be revised/tweaked as experience is gained with the first few optical alignments.

b) The counter-balanced periscope addition to the visible laser autocollimator on top of the Total Station may overload the gimbal and cause lack of repeatability. This will be tested early. If necessary we will revert to the iLIGO method of changing the Total Station height when switching from the Total Station to the autocollimator.

24) Items yet to be done or addressed:

a) Give requirements for light intensity for COS autocollimator in pointing mode and autocollimation mode

b) Synopsis of quad assy alignment steps in section 10.2.1 including figures to illustrate

c) **Need to discuss alignment of baffles and beam dumps in HAM chambers, or is this IO scope?**

d) **Need to discuss how to support HWS alignment**

e) Alignment error budget should also address positional accuracy

f) Complete alignment parameters table for all optics indicating pitch, yaw, height, monuments, etc

g) Include reference to the SUS assembly procedures that indicate how yaw is adjusted with the top springs for all suspensions

h) Need test stand location drawings for each building (and then revise references in section 10.2.2)

i) Complete the alignment layout drawings (7 of 21 completed)

j) Section 10.2.5.3.1: FM: (a) alternative is to align to surface FM normal (test stand does not block line of sight), (b) indicate how to set up large optical reference flat alignment

k) Add sub-section to precision alignment for cartridge regarding BS alignment, including ITM elliptical baffles (section 10.2.5.3). BS corner cube attachment (D000430) should be mentioned

l) Address alignment of the OFI (in section 10.1.4?)

19 References

(add optic positions and orientations document)

D0901920 [Advanced LIGO H1 Optical Layout, ZEMAX](#)

D0902345 [Advanced LIGO H2 Optical Layout, ZEMAX](#)

D0902216 [Advanced LIGO L1 Optical Layout, ZEMAX](#)

- [T980072](#)-v1 COS IR Autocollimator Alignment System
- [T980019](#)-x0 ASC Initial Alignment Subsystem Final Design
- [D970210](#)-v2 ASC Monument Locations – Washington Site
- [D980499](#)-C ASC Equipment Layout, Louisiana Site *[sheets 3-5 give monument locations]*
- [T080307](#)-v3 AOS Initial Alignment System Design Requirements

- [T000065-05](#), "COS 4K IFO Alignment Procedure" *[using IR Laser Autocolimator]*

- [T990088-01](#), "COS IFO Alignment Procedure" *[using IR Laser Autocolimator]*

- [T970151-C](#), "ASC Initial Alignment Procedures" *[using Theodolite Total Station and Visible Laser Autocolimator]*

- [T970060-00](#), "Alignment Sensing/Control Preliminary Design" *[covers all alignment, not just IAS]*

- [T952007-04](#), "Alignment Sensing/Control Design Requirements Document" *[covers all alignment, not just IAS]*

- [E1000189](#)-v1, "Tolerance Analysis - HAM ISI Table Position"
- T1100064-v1, "Sokkia AutoLevel Brochure"