

APPROX.
3.59
[91.1]

DETAIL A
SCALE 1:8

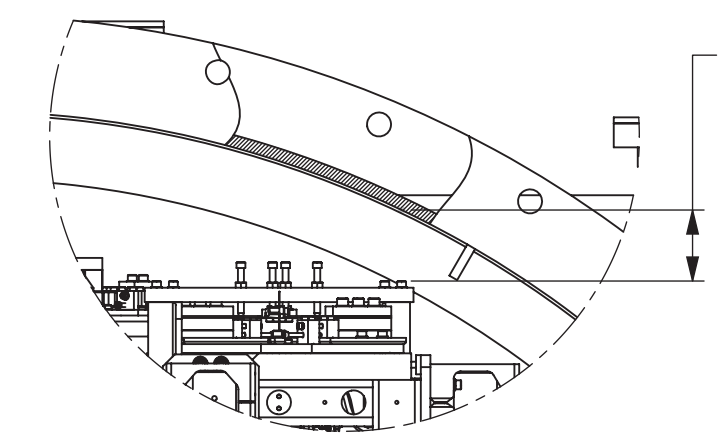

APPROX.
2.96
[75.1]

DETAIL B
SCALE 1:8

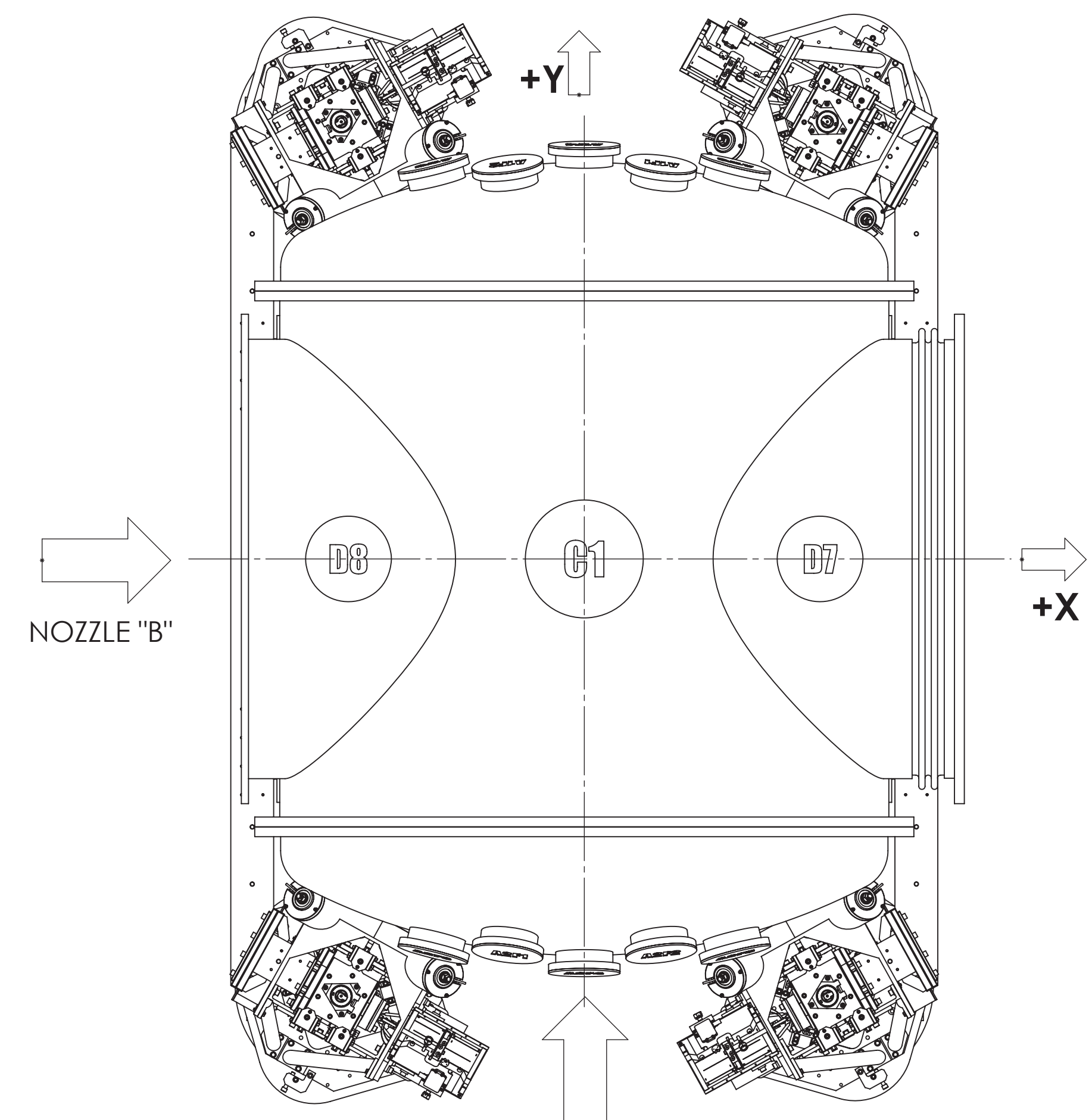

NOZZLE "B"

+X

NOZZLE "A"
TOP VIEW

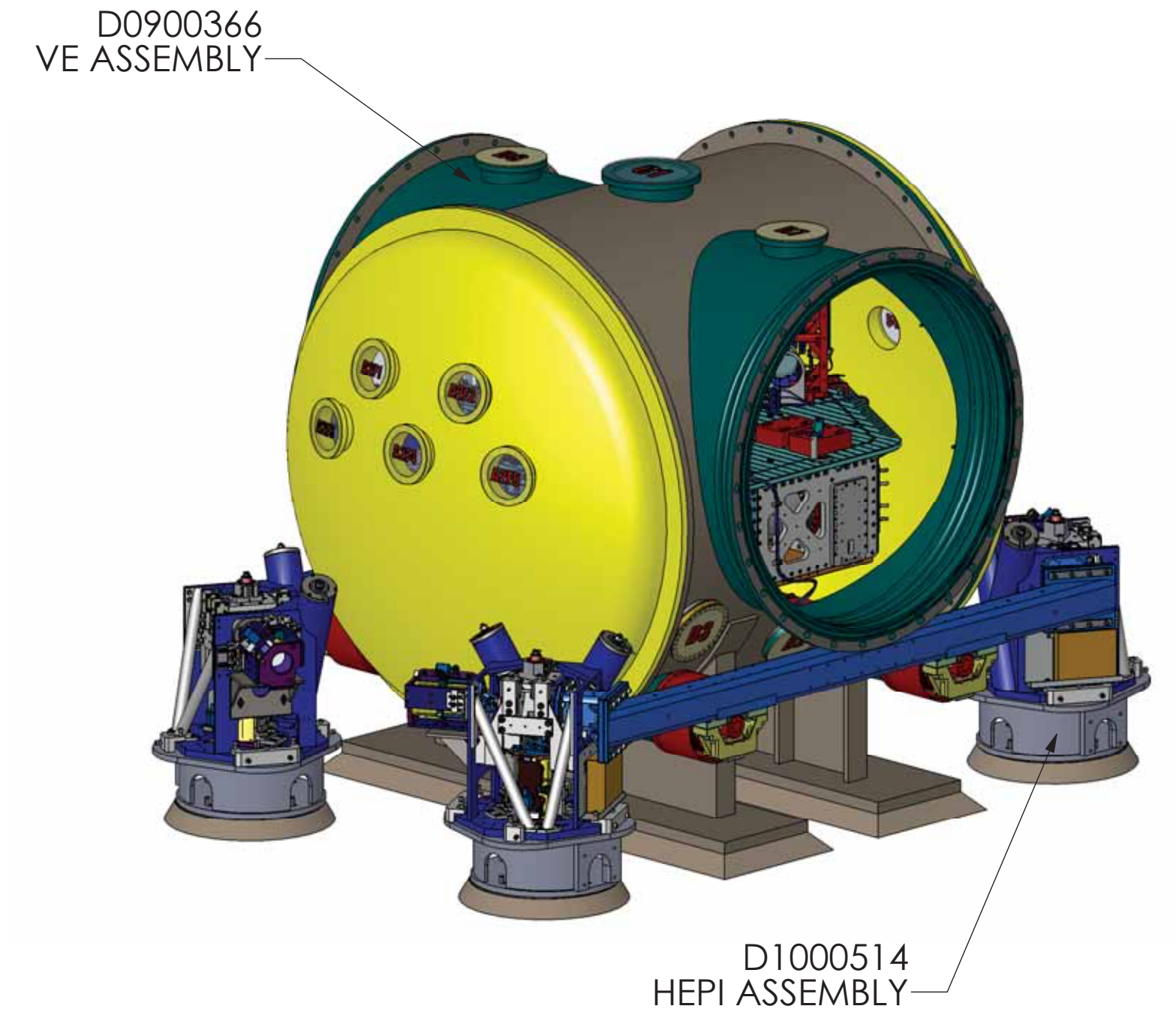

D1000514
HEPI ASSEMBLY

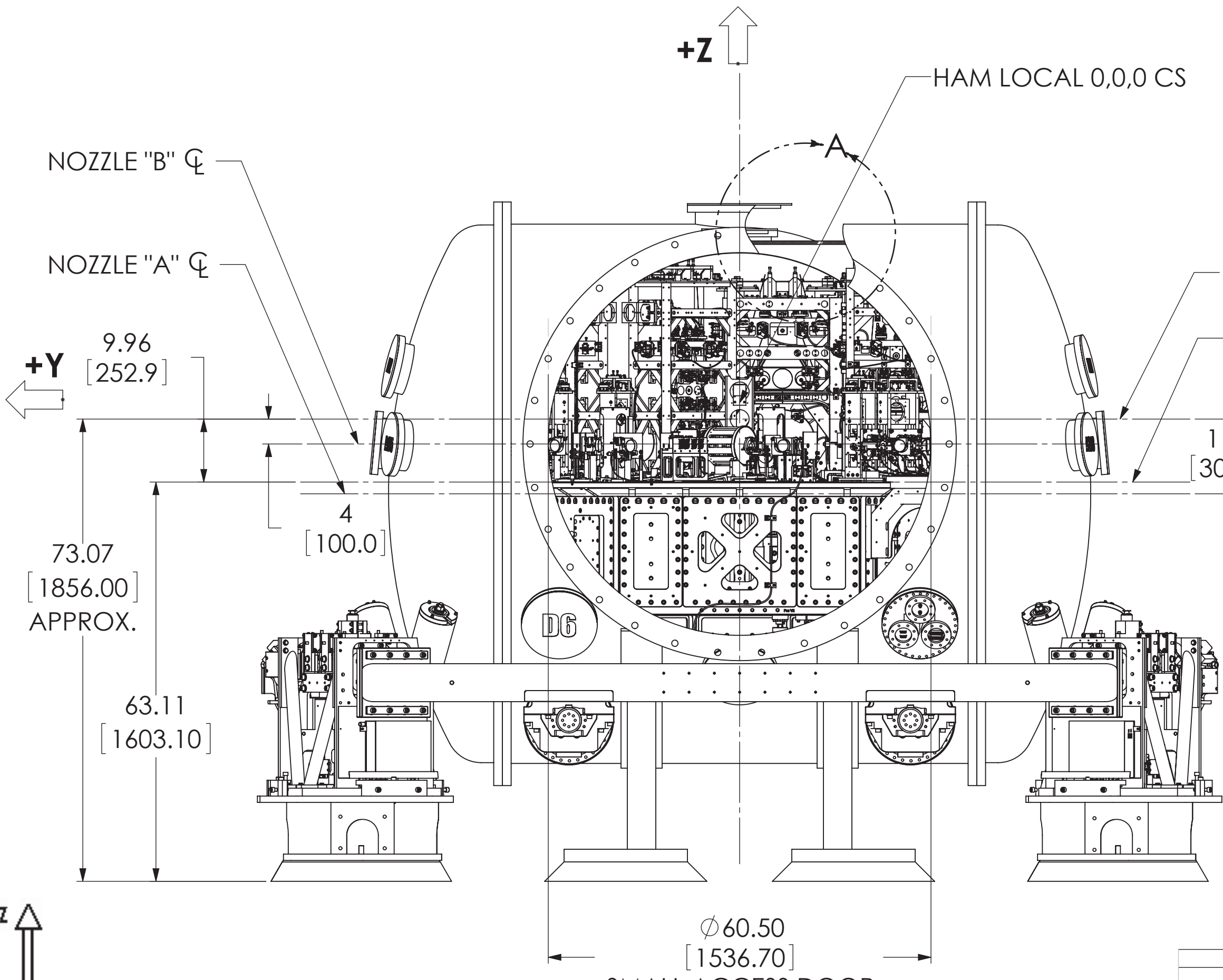

LEFT VIEW

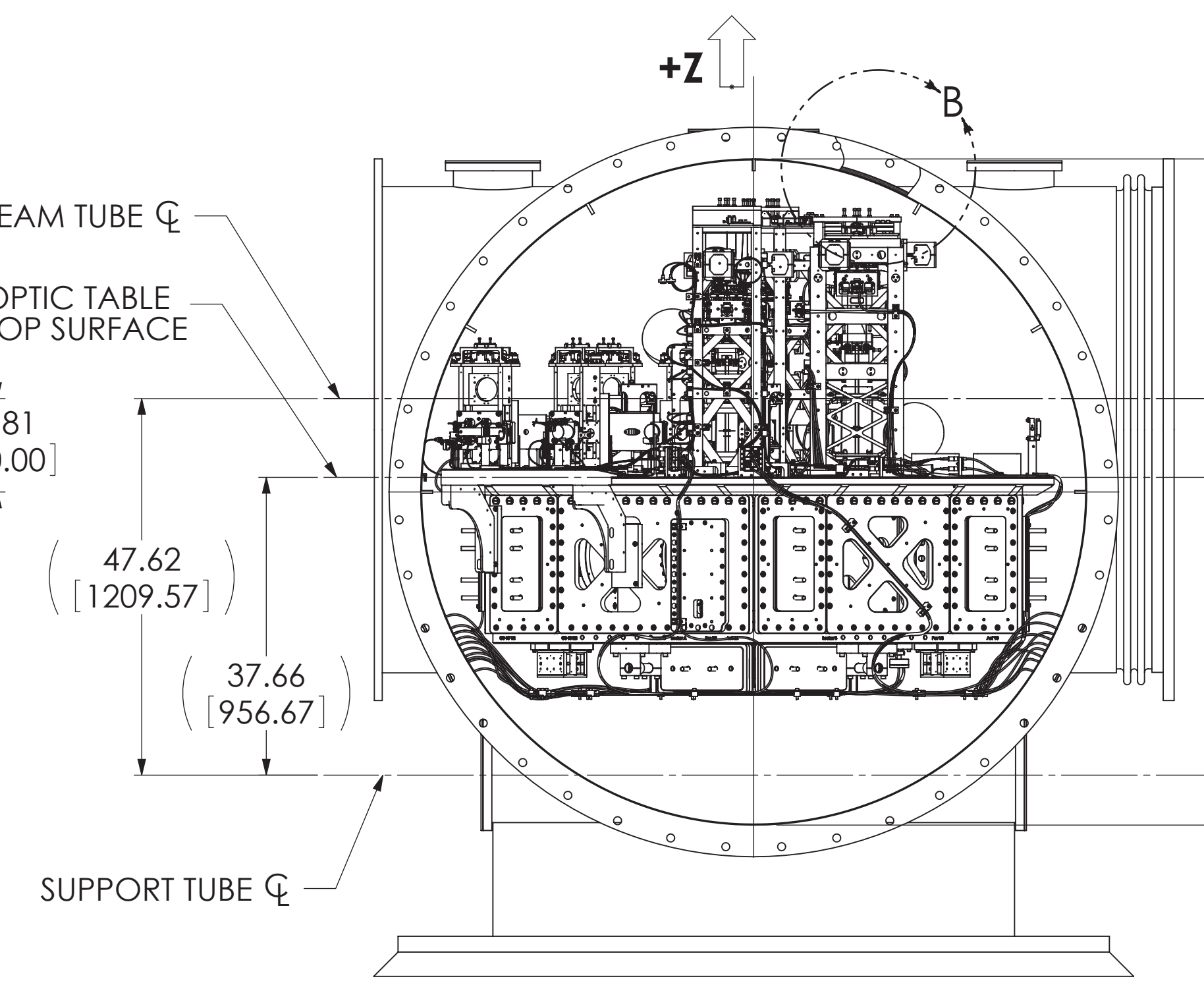

FRONT VIEW

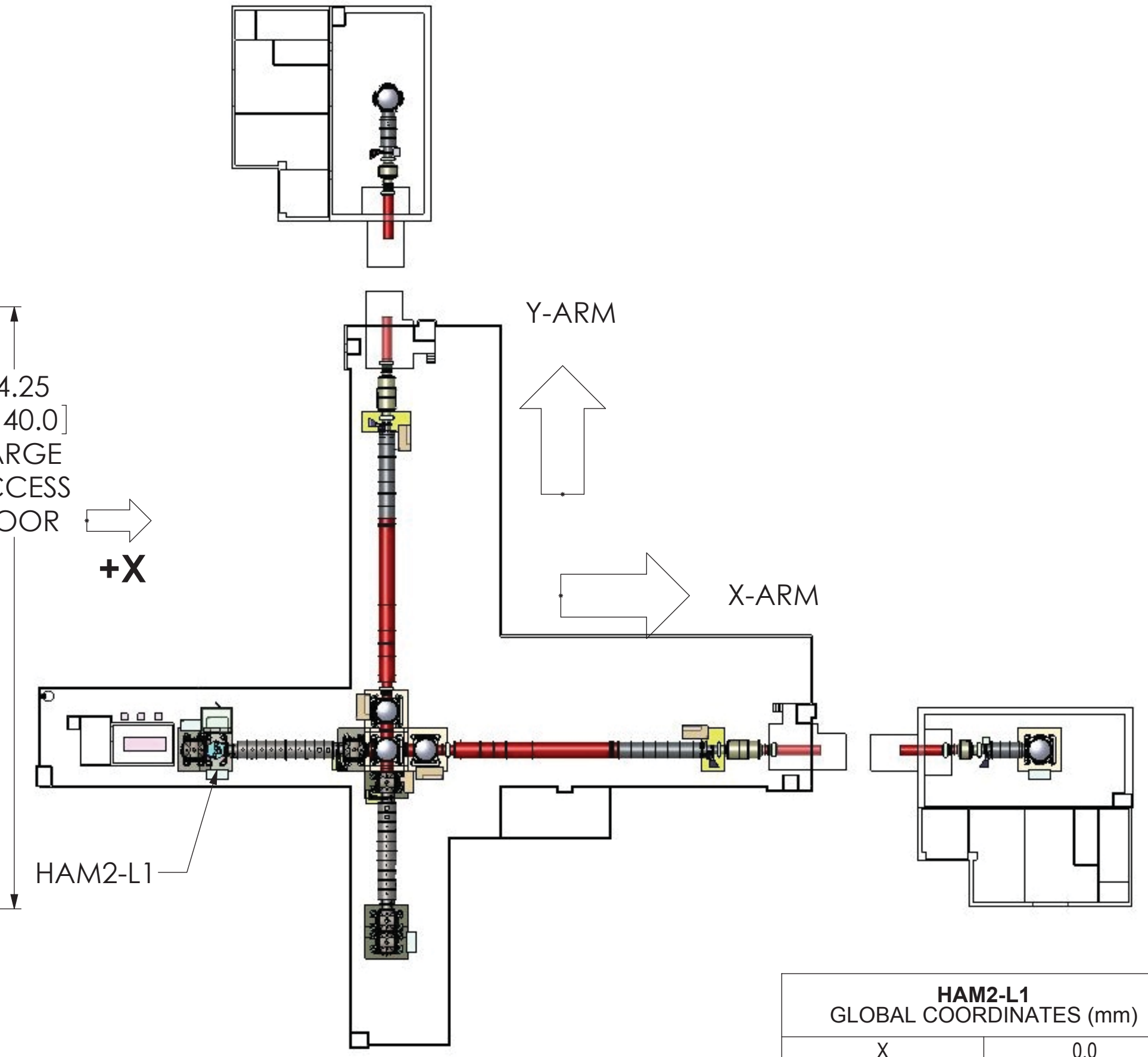

HAM2-L1 GLOBAL COORDINATES (mm)	
X	0.0
Y	-20122.0
Z	0.0

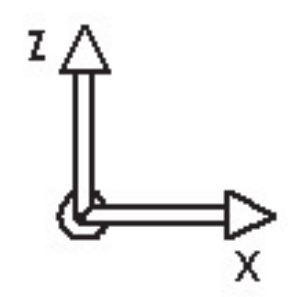

Global Axes
Front View

NOTES AND TOLERANCES: (UNLESS OTHERWISE SPECIFIED)

MATERIAL	N/A	FINISH	N/A μinch
----------	-----	--------	-----------

CALIFORNIA INSTITUTE OF TECHNOLOGY MASSACHUSETTS INSTITUTE OF TECHNOLOGY		PART NAME	
SYSTEM	ADVANCED LIGO	SUB-SYSTEM	SUS
NEXT ASSY		DESIGNER	ED CHAVEZ
		DRAFTER	ED CHAVEZ
		CHECKER	C. TORRIE
		APPROVAL	SEE DCC

HAM2-L1 TOP LEVEL CHAMBER ASSEMBLY, FULLY DEFINED				SIZE	DWG. NO.	REV.
DATE	27 JUL 2009	DATE	27 JUL 2011	D	D0900365	v8
SCALE: 1:16		PROJECTION:		SHEET 1 OF 6		

D0900365 Adv LIGO Systems: HAM2-L1 Top Level Chamber Assembly: ALL PART PDM REV: X-072, DRAWING PDM REV: X-014

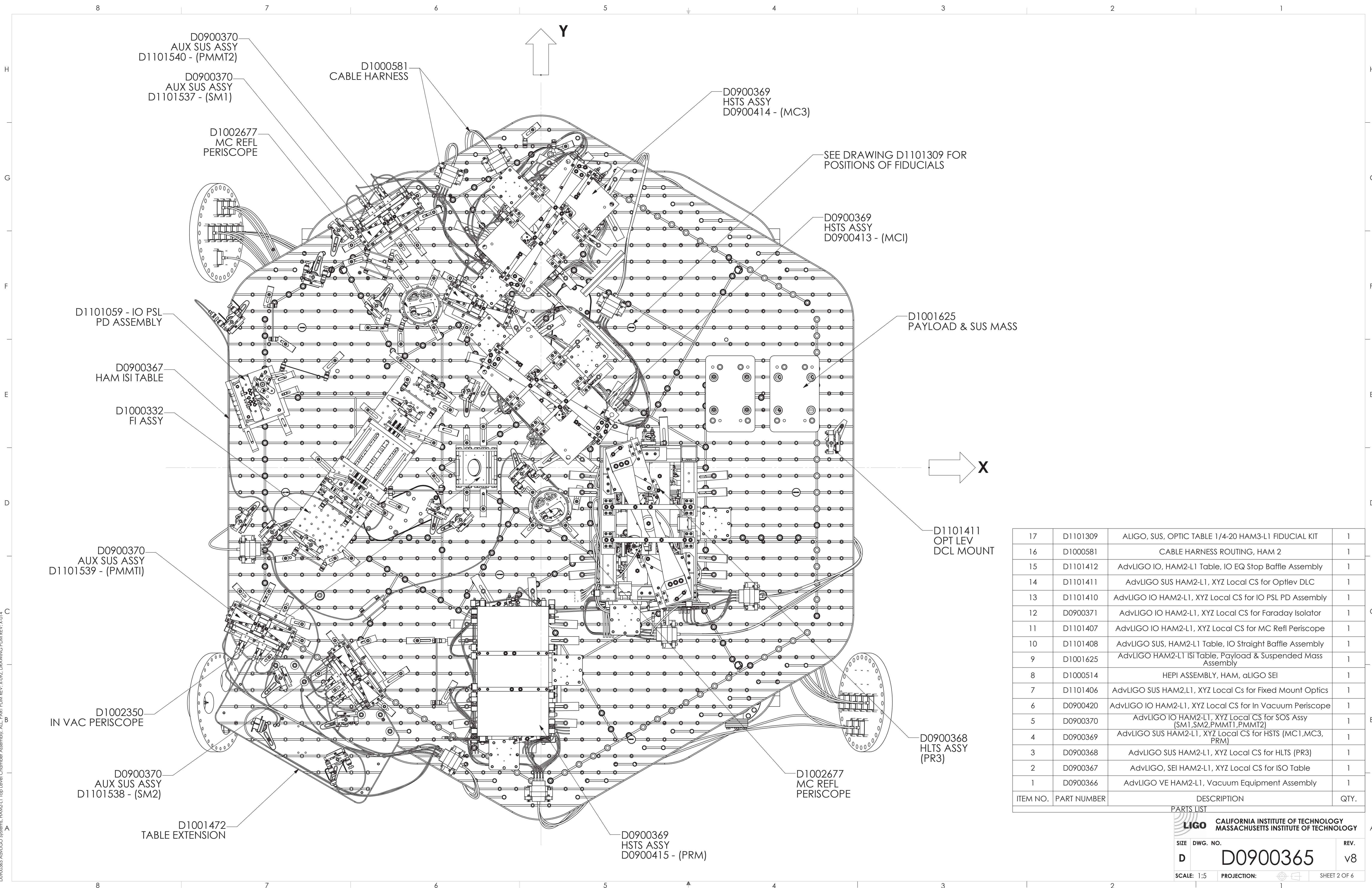

D0900365 AdvLIGO Systems HAM2-L1 Top Level Chamber Assembly, ALL PART PDM REV. X-092, DRAWING PDM REV. X-014

ITEM NO.	PART NUMBER	DESCRIPTION	QTY.
17	D1101309	ALIGO, SUS, OPTIC TABLE 1/4-20 HAM3-L1 FIDUCIAL KIT	1
16	D1000581	CABLE HARNESS ROUTING, HAM 2	1
15	D1101412	AdvLIGO IO, HAM2-L1 Table, IO EQ Stop Baffle Assembly	1
14	D1101411	AdvLIGO SUS HAM2-L1, XYZ Local CS for Optlev DLC	1
13	D1101410	AdvLIGO IO HAM2-L1, XYZ Local CS for IO PSL PD Assembly	1
12	D0900371	AdvLIGO IO HAM2-L1, XYZ Local CS for Faraday Isolator	1
11	D1101407	AdvLIGO IO HAM2-L1, XYZ Local CS for MC Refl Periscope	1
10	D1101408	AdvLIGO SUS, HAM2-L1 Table, IO Straight Baffle Assembly	1
9	D1001625	AdvLIGO HAM2-L1 ISI Table, Payload & Suspended Mass Assembly	1
8	D1000514	HEPI ASSEMBLY, HAM, aLIGO SEI	1
7	D1101406	AdvLIGO SUS HAM2,L1, XYZ Local Cs for Fixed Mount Optics	1
6	D0900420	AdvLIGO IO HAM2-L1, XYZ Local CS for In Vacuum Periscope	1
5	D0900370	AdvLIGO IO HAM2-L1, XYZ Local CS for SOS Assy (SM1,SM2,PMMT1,PMMT2)	1
4	D0900369	AdvLIGO SUS HAM2-L1, XYZ Local CS for HSTS (MC1,MC3,PRM)	1
3	D0900368	AdvLIGO SUS HAM2-L1, XYZ Local CS for HLTS (PR3)	1
2	D0900367	AdvLIGO, SEI HAM2-L1, XYZ Local CS for ISO Table	1
1	D0900366	AdvLIGO VE HAM2-L1, Vacuum Equipment Assembly	1

PARTS LIST

LIGO CALIFORNIA INSTITUTE OF TECHNOLOGY
MASSACHUSETTS INSTITUTE OF TECHNOLOGY

SIZE	DWG. NO.	REV.
D	D0900365	v8

SCALE: 1:5 PROJECTION: SHEET 2 OF 6

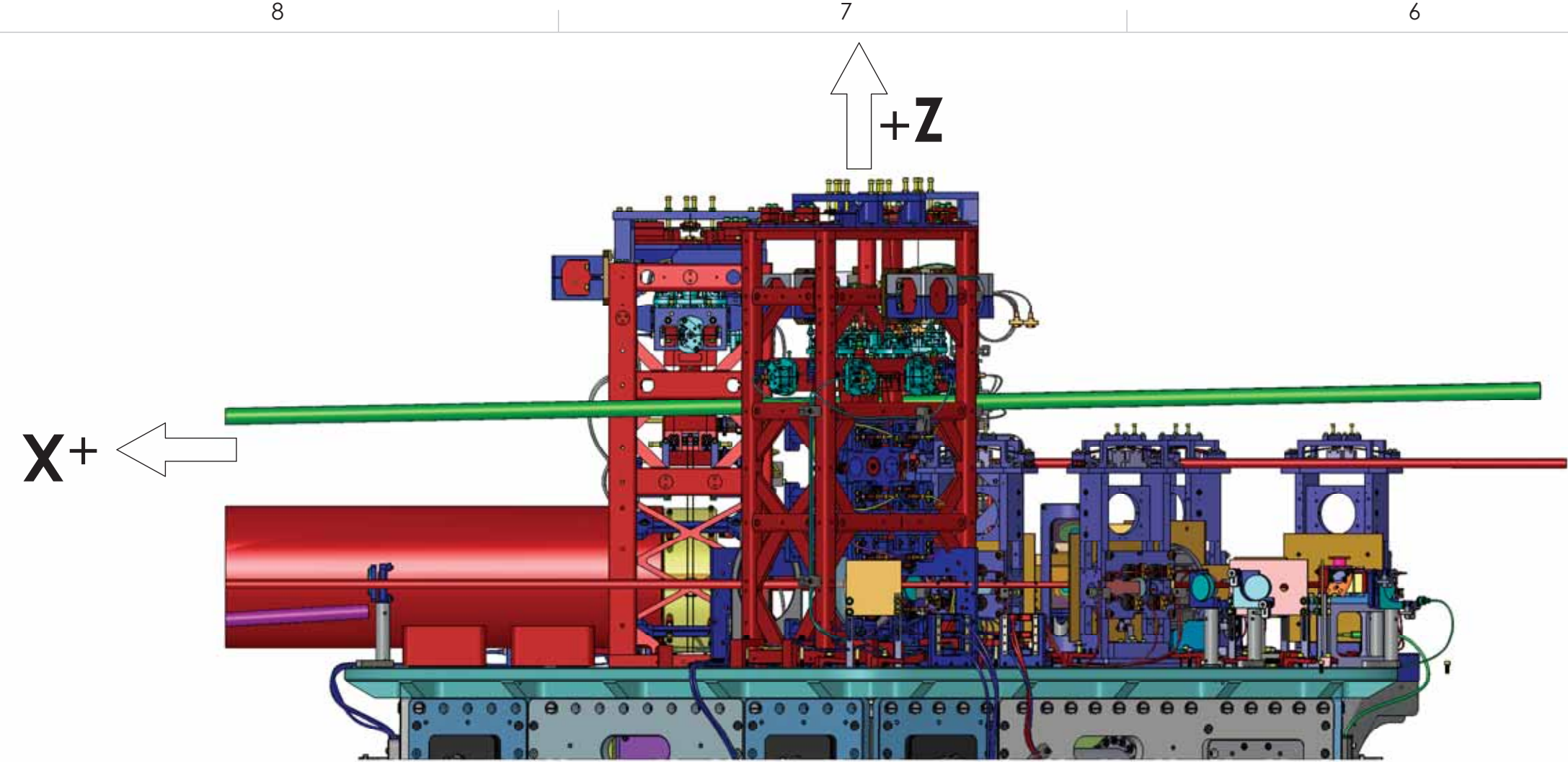

REAR VIEW
(ROTATED 180 DEGREES CCW)

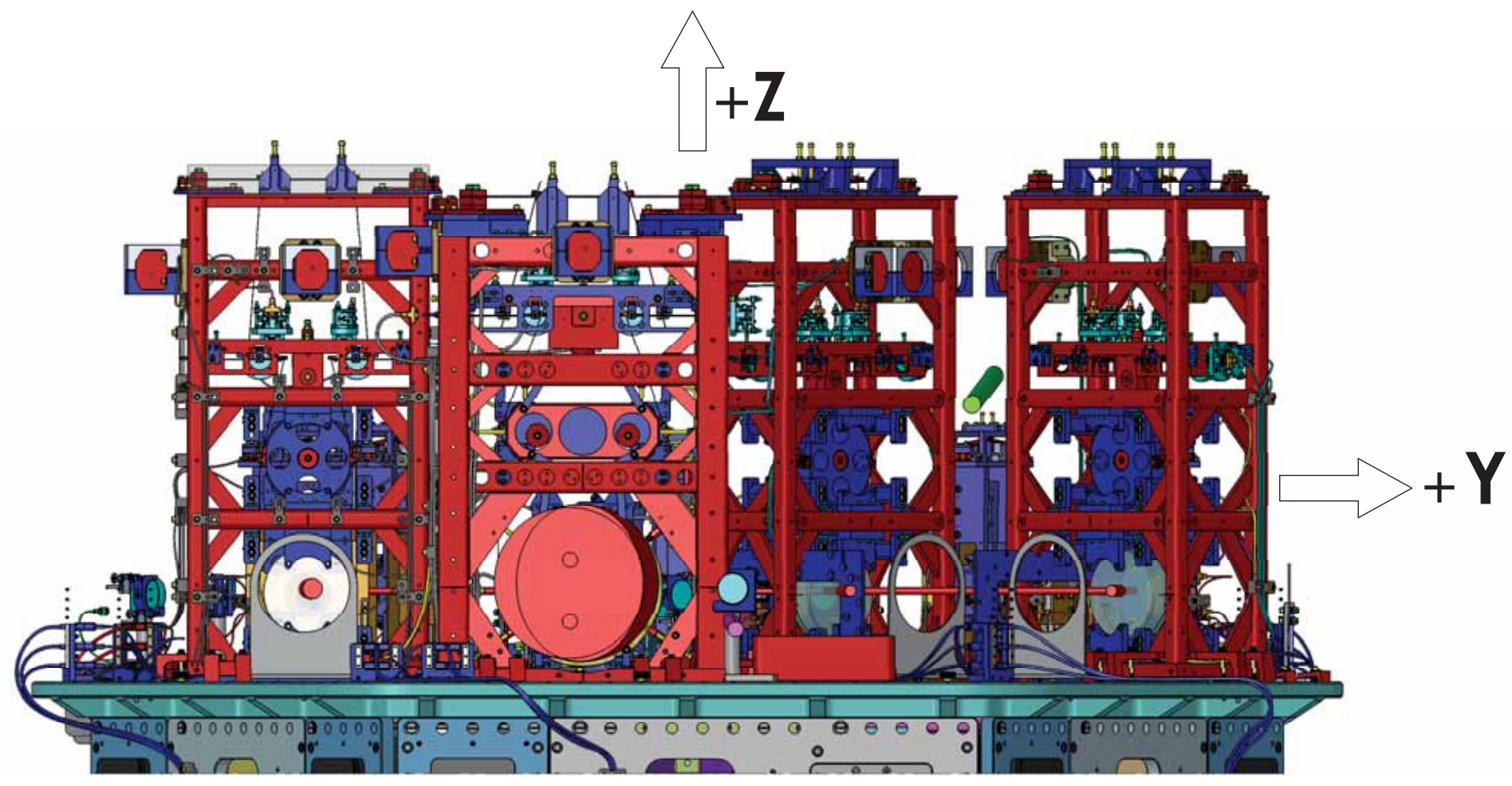

RIGHT SIDE VIEW
(ROTATED 180 DEGREES CCW)

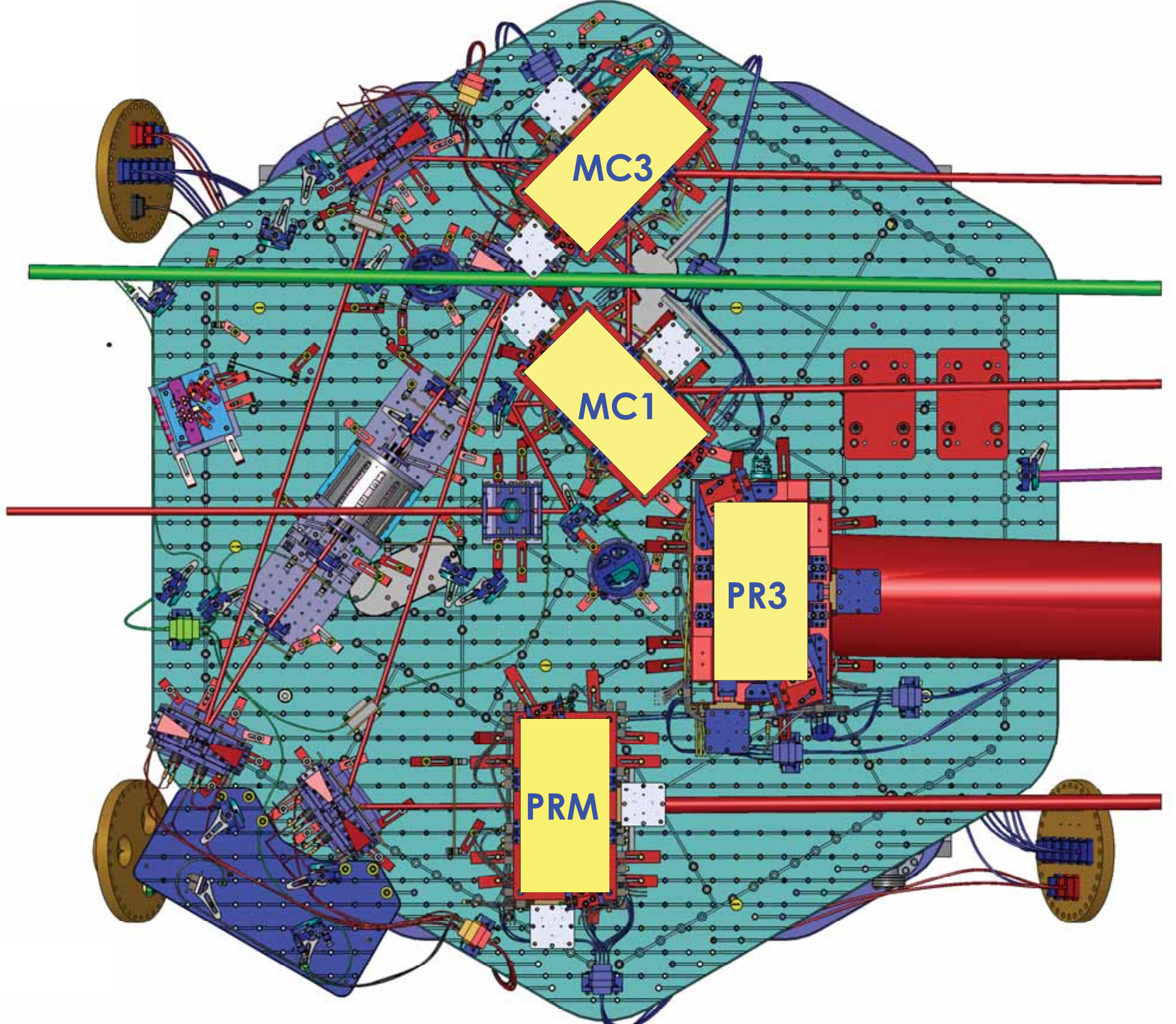

TOP VIEW

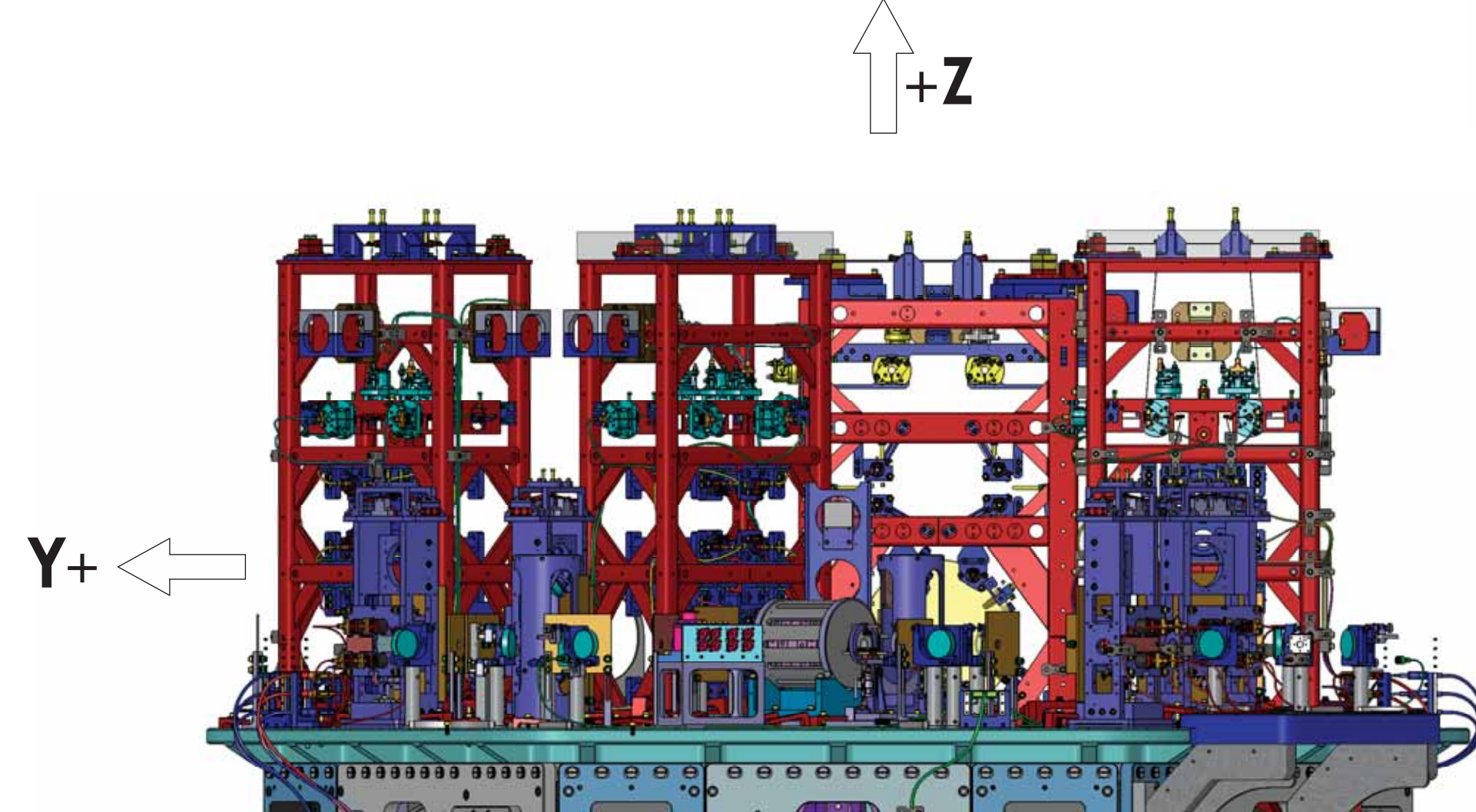

LEFT SIDE VIEW
(ROTATED 90 DEGREES CCW)

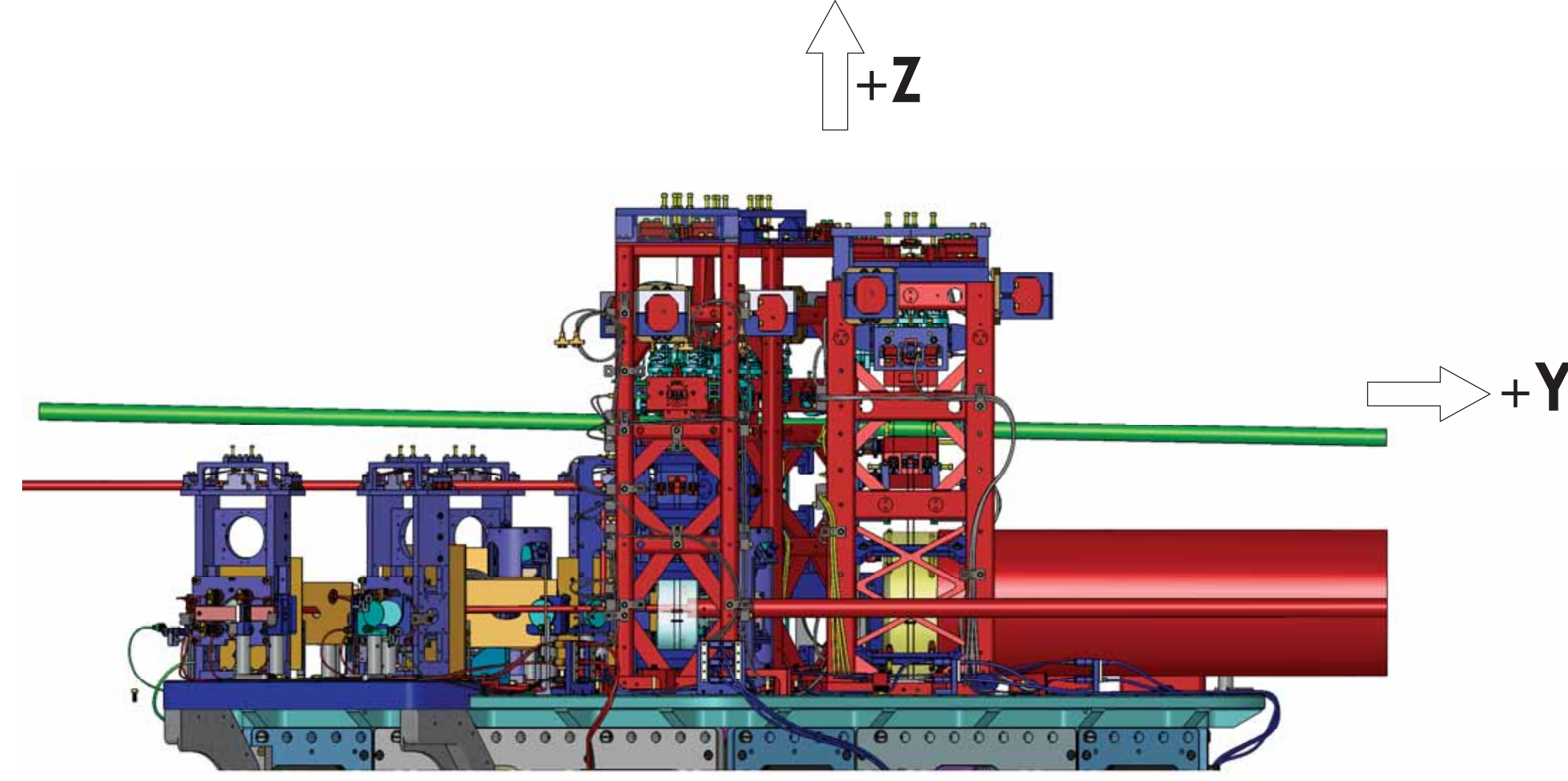

FRONT VIEW

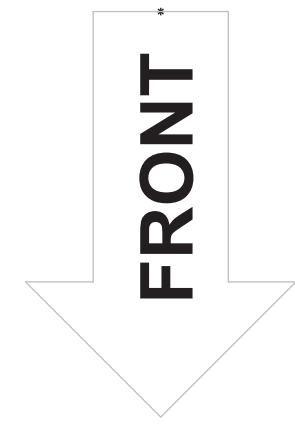

LASER BEAMS - ORTHO VIEWS

CALIFORNIA INSTITUTE OF TECHNOLOGY MASSACHUSETTS INSTITUTE OF TECHNOLOGY		
SIZE	DWG. NO.	REV.
D	D0900365	v8
SCALE: 1:8	PROJECTION:	SHEET 3 OF 6

DDP0365-Asst LIGO Systems: HAM2-L1 Top Level Chamber Assembly: ALL PART PDM REV: X-072 DRAWING PDM REV: X-014

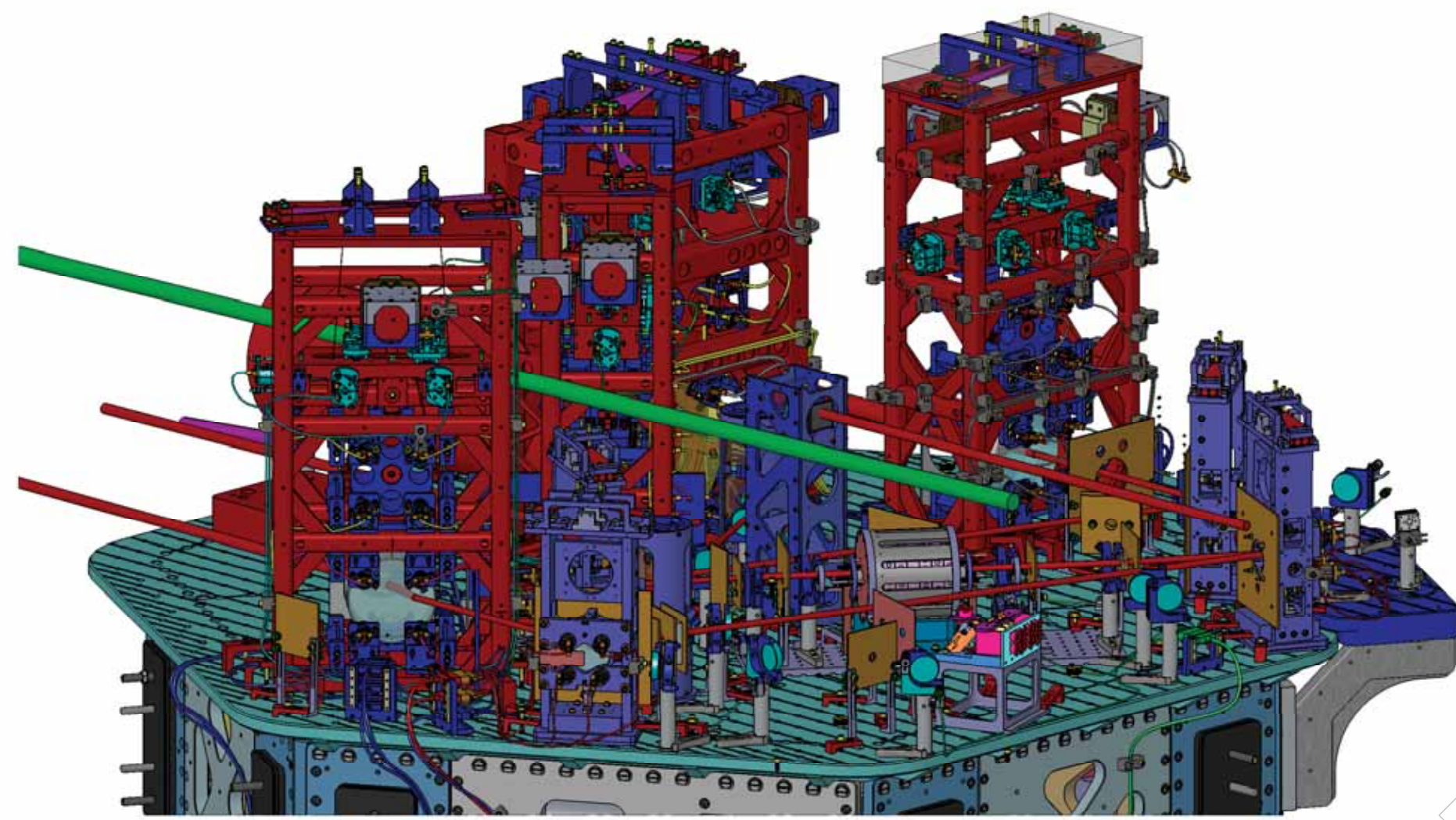

ISO REAR - LEFT

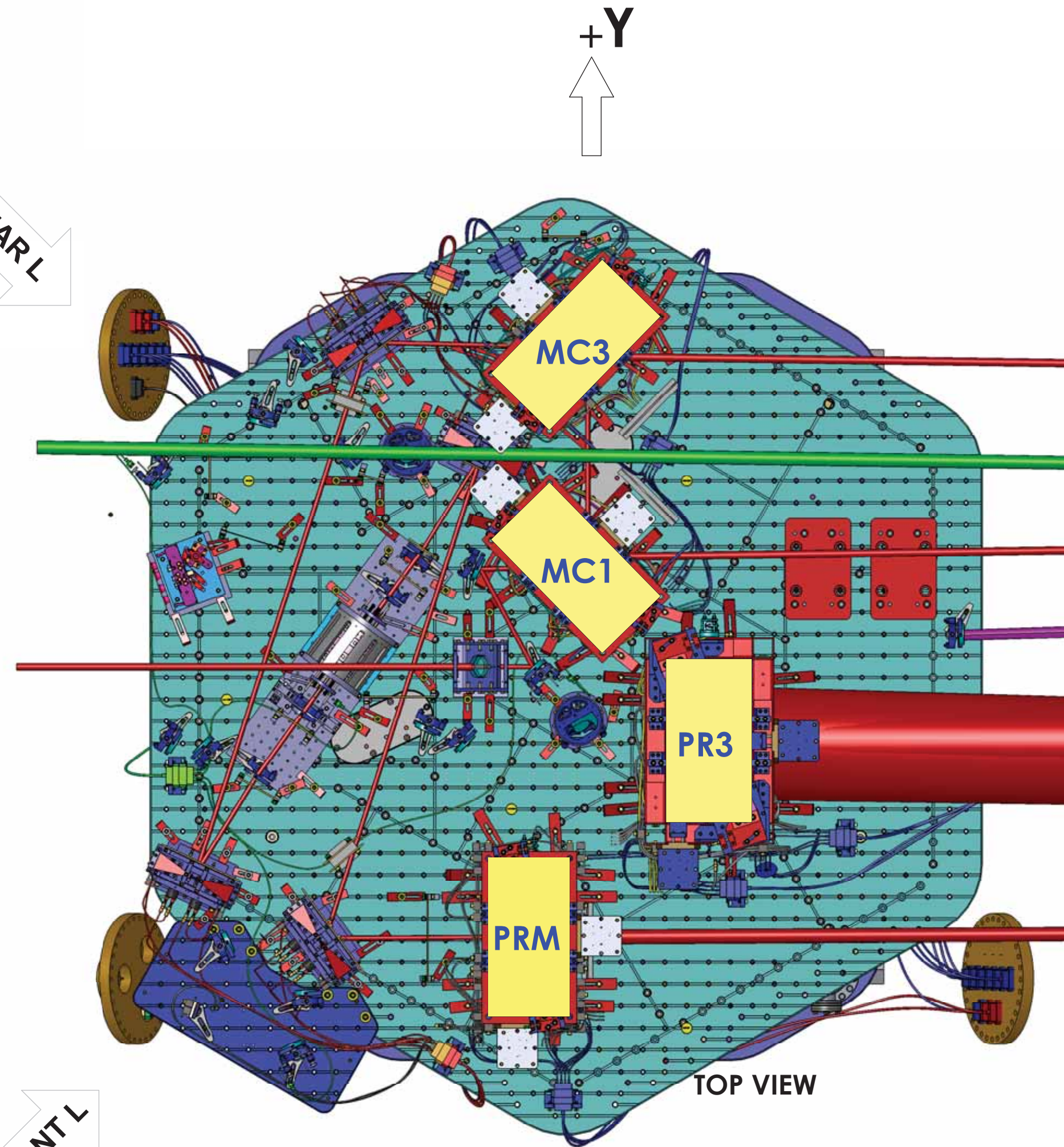

TOP VIEW

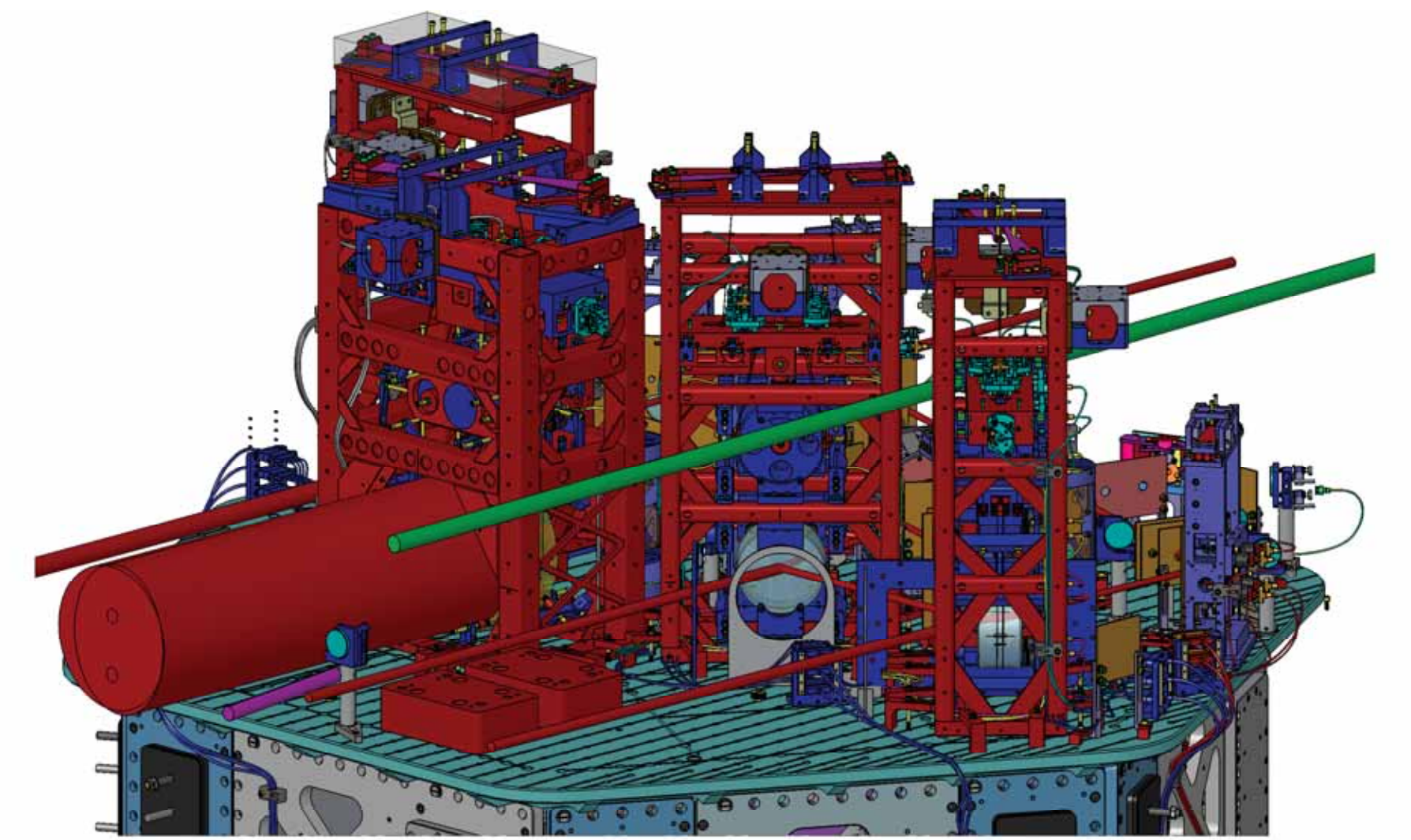

ISO REAR - RIGHT

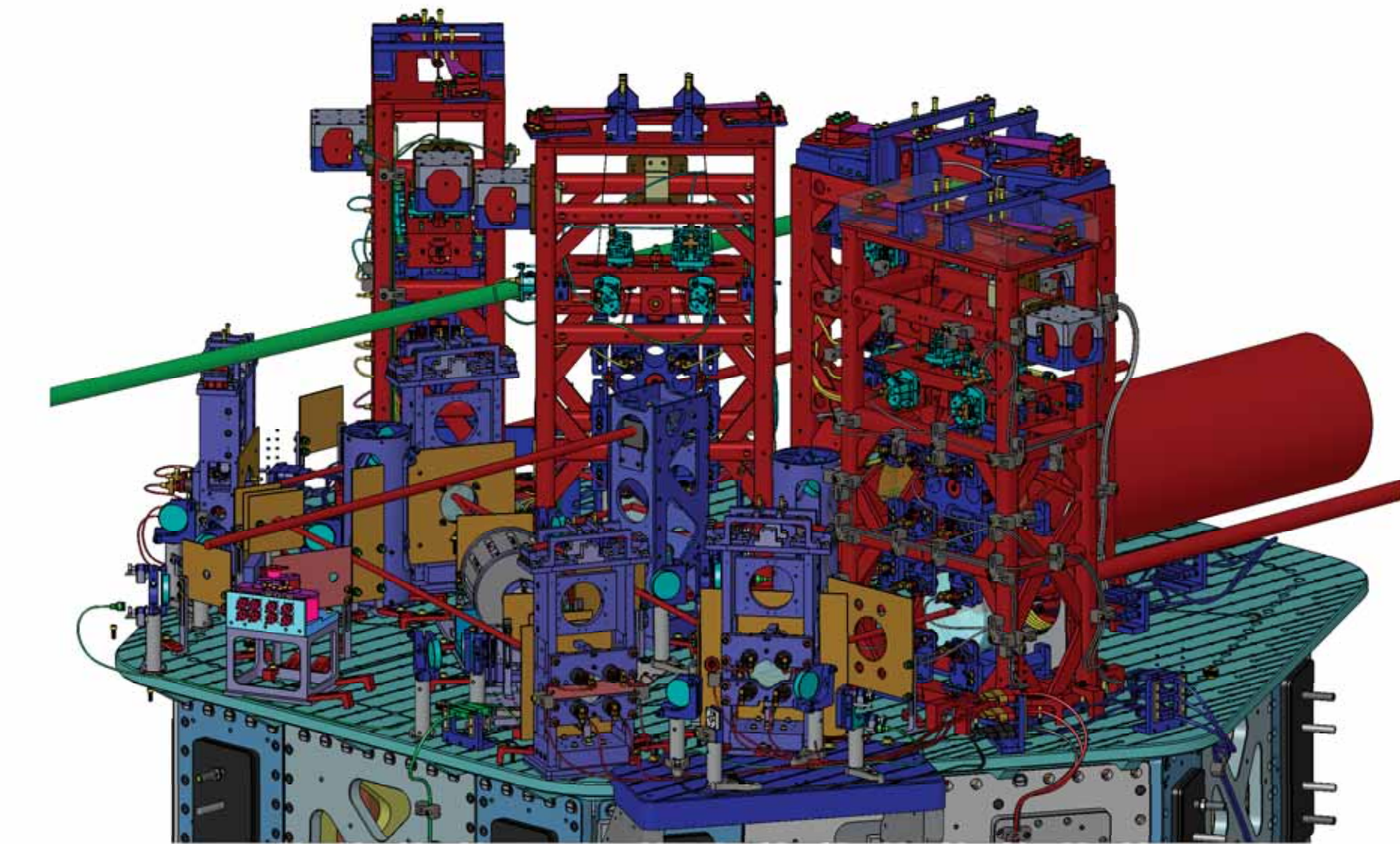
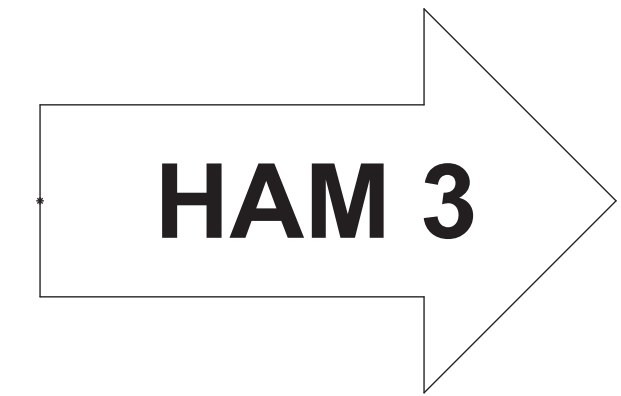
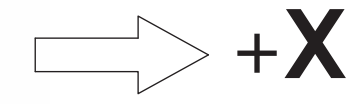

ISO FRONT - LEFT

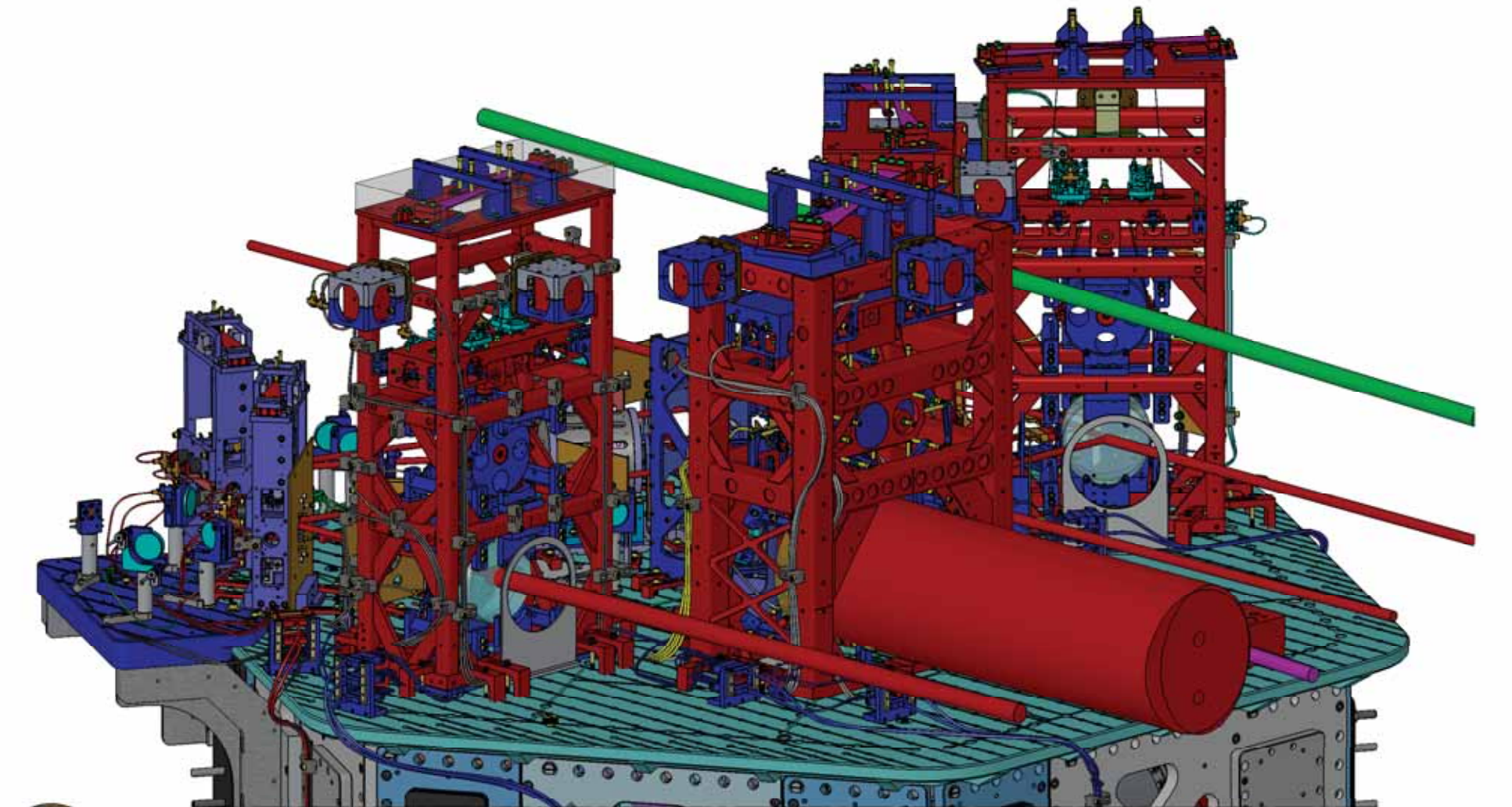

ISO FRONT - RIGHT

LASER BEAMS - ISO VIEWS

CALIFORNIA INSTITUTE OF TECHNOLOGY MASSACHUSETTS INSTITUTE OF TECHNOLOGY		REV.
SIZE DWG. NO.	D0900365	v8
SCALE: 1:8	PROJECTION:	SHEET 4 OF 6

DDP00365-Asst LIGO Systems: HAM2-L1 Top Level Chamber Assembly: ALL PART PDM REV: X-072, DRAWING PDM REV: X-014

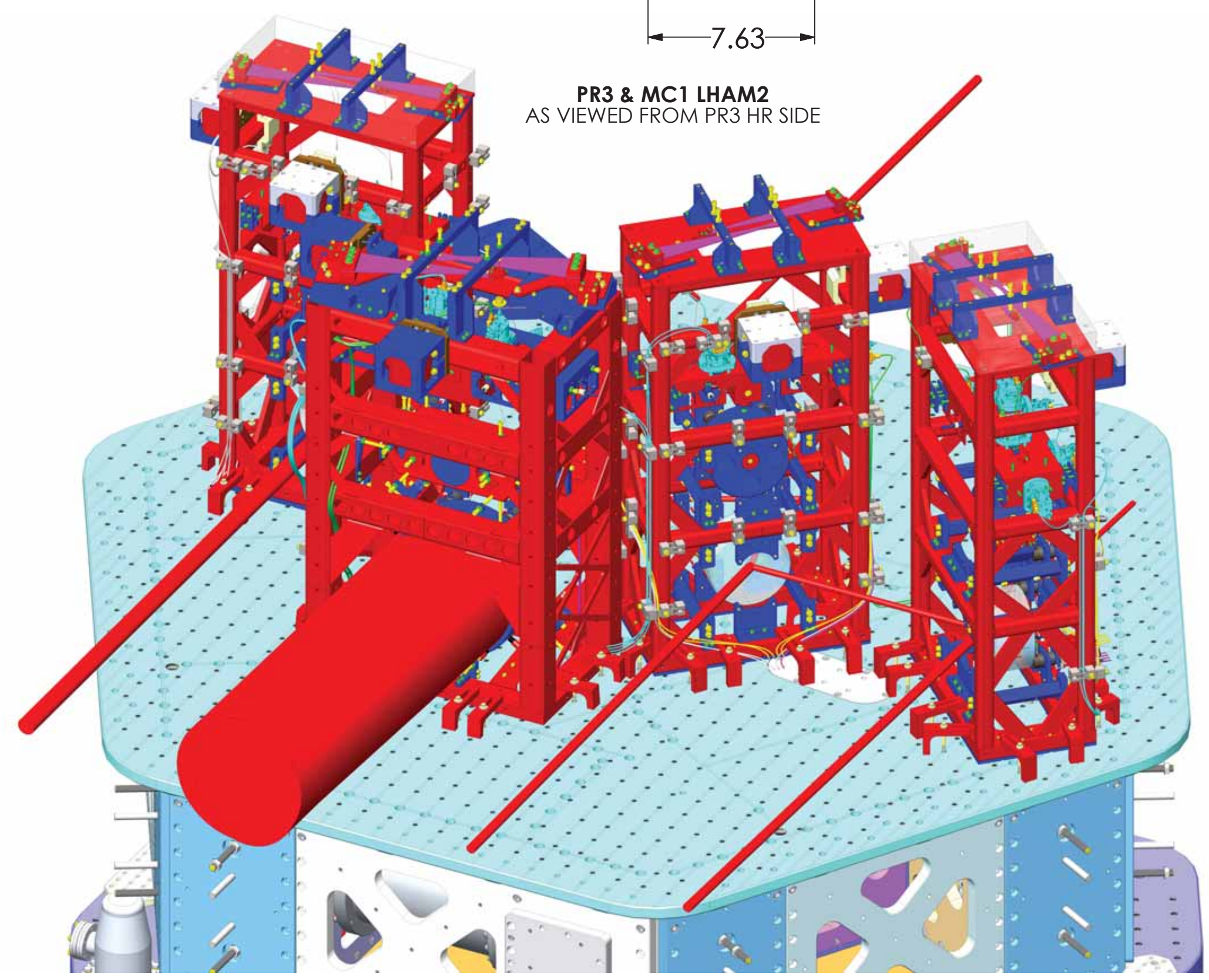
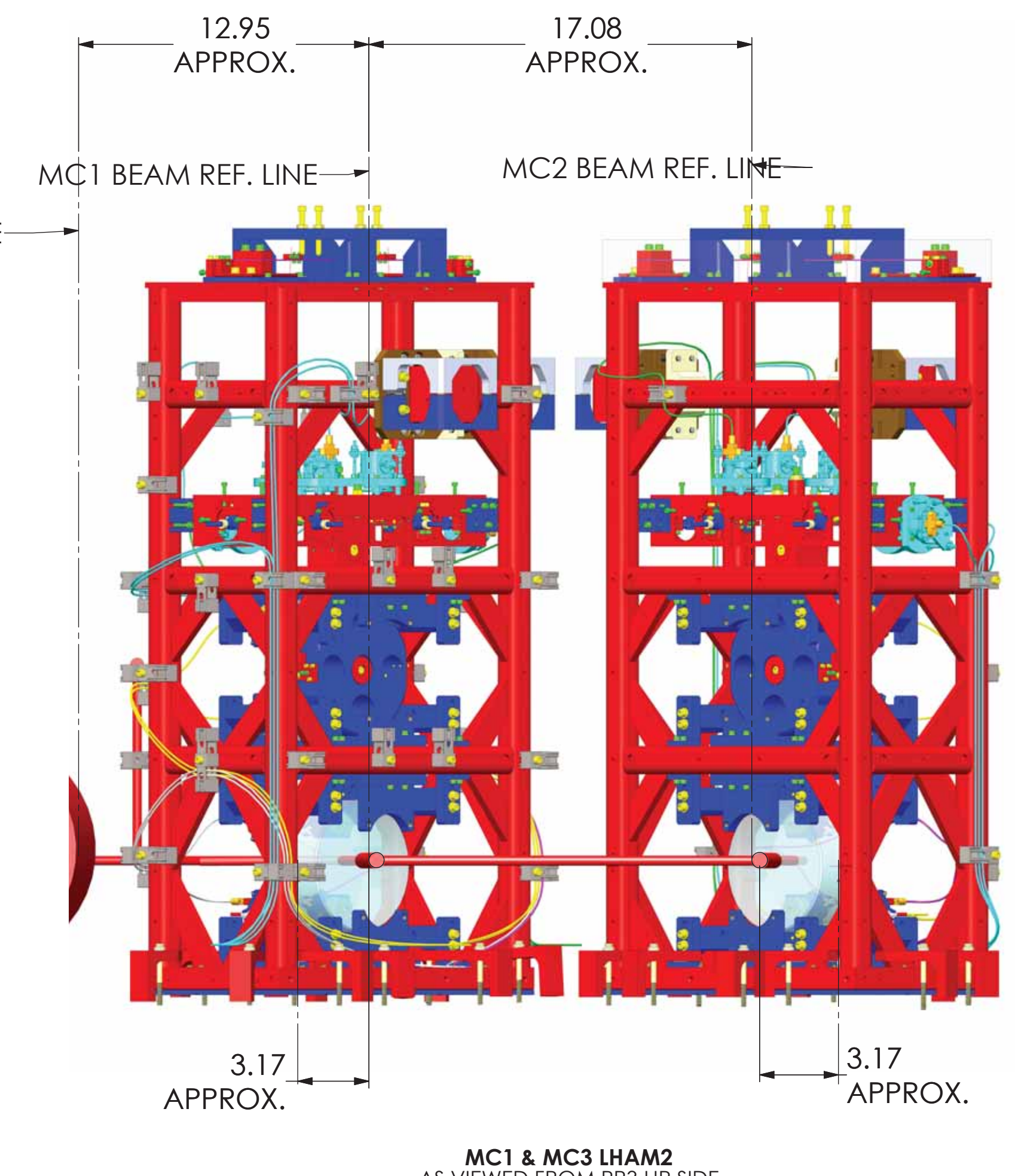
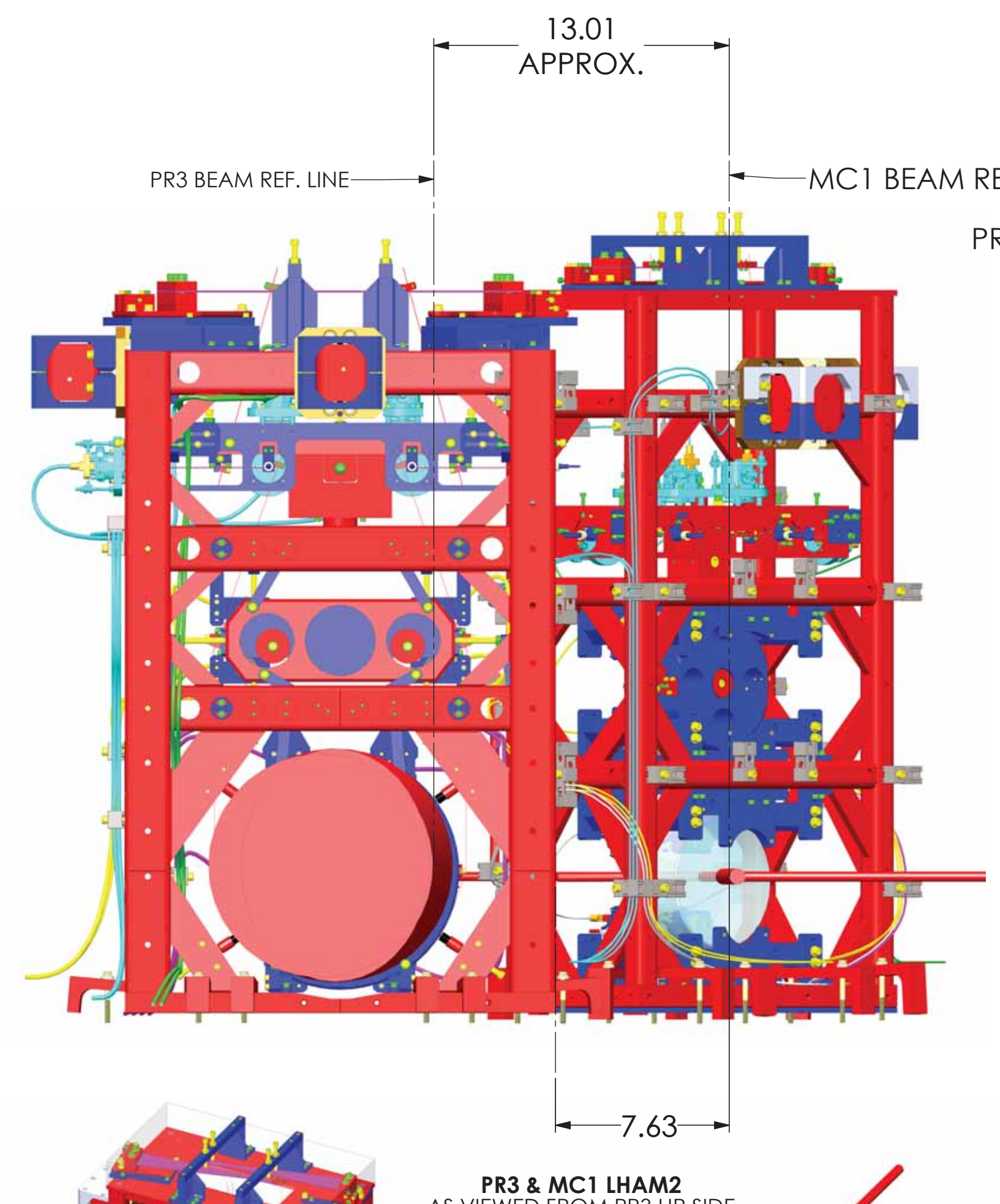
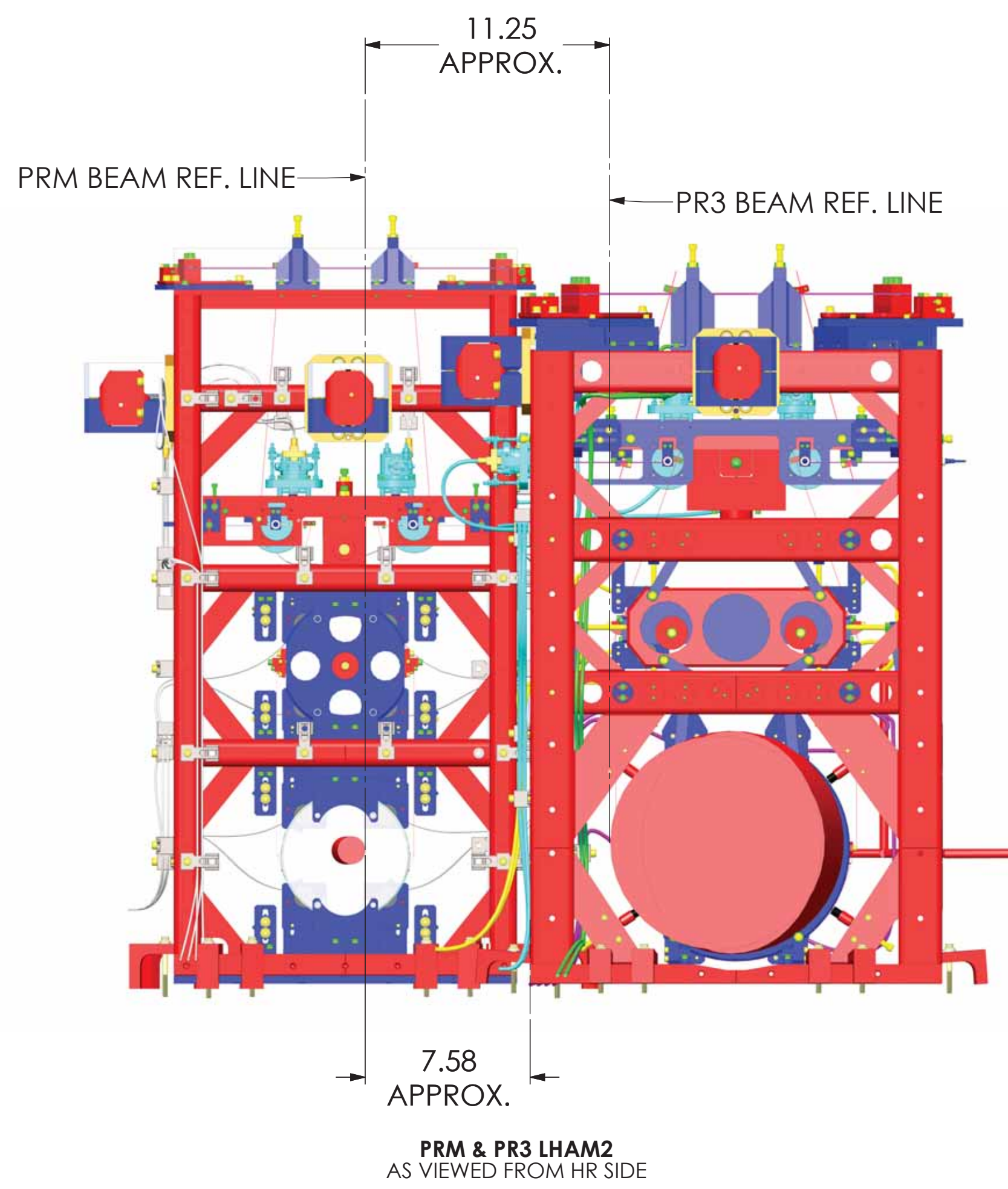

LASER BEAMS HR SIDE CLEARANCES

LIGO CALIFORNIA INSTITUTE OF TECHNOLOGY MASSACHUSETTS INSTITUTE OF TECHNOLOGY	
SIZE DWG. NO.	REV.
D D0900365	v8
SCALE: NTS	PROJECTION:
SHEET 5 OF 6	

DDP00365-AsstLIGO Systems-HAM2-L1 Top Level Chamber Assembly-All Part PDM REV.: DRAWING PDM REV: X014

8 7 6 5 4 3 2 1

H
G
F
E
D
C
B
A

H
G
F
E
D
C
B
A

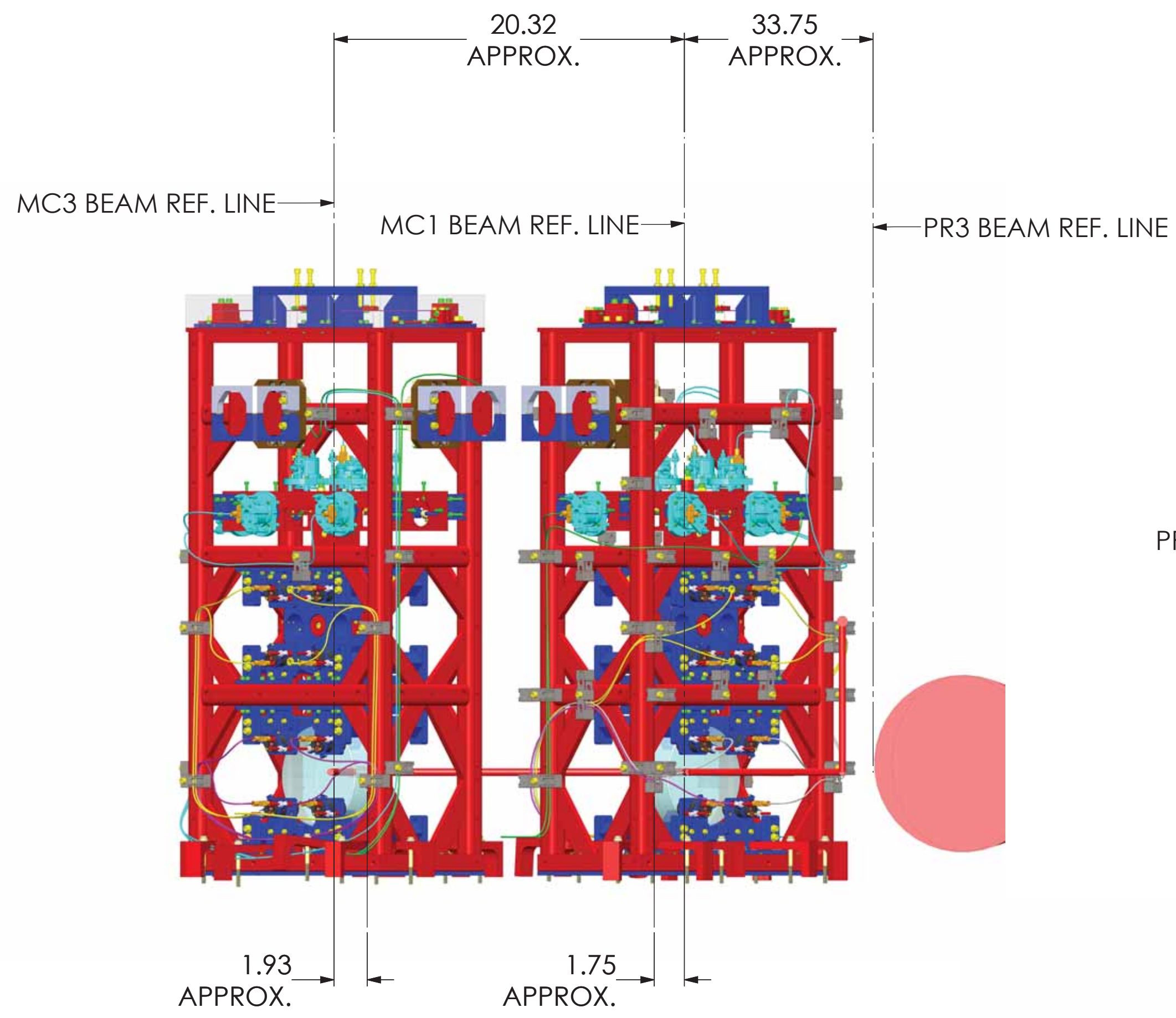

MC3 & MC1 LHAM2
AS VIEWED FROM AR SIDE

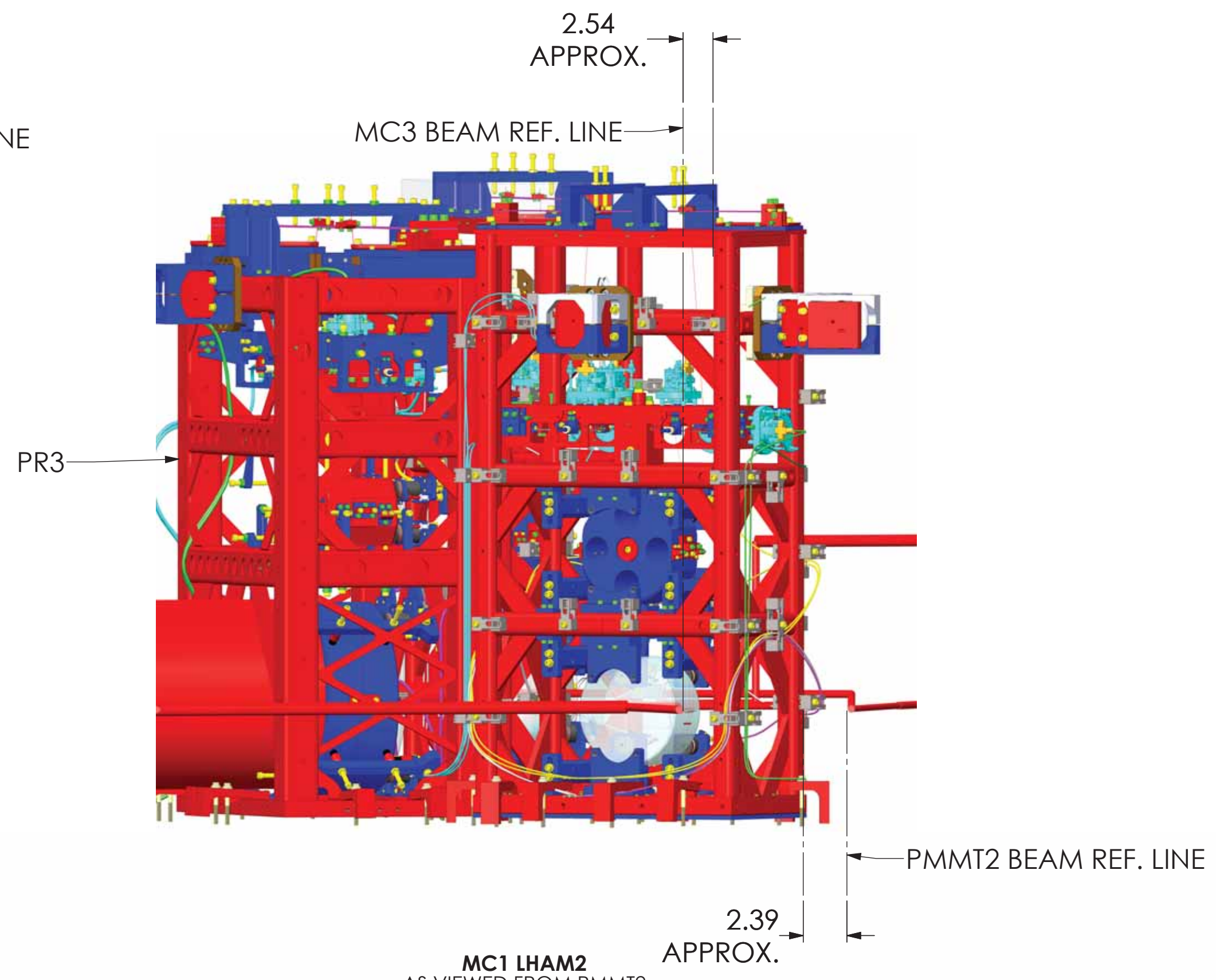

MC1 LHAM2
AS VIEWED FROM PMMT2

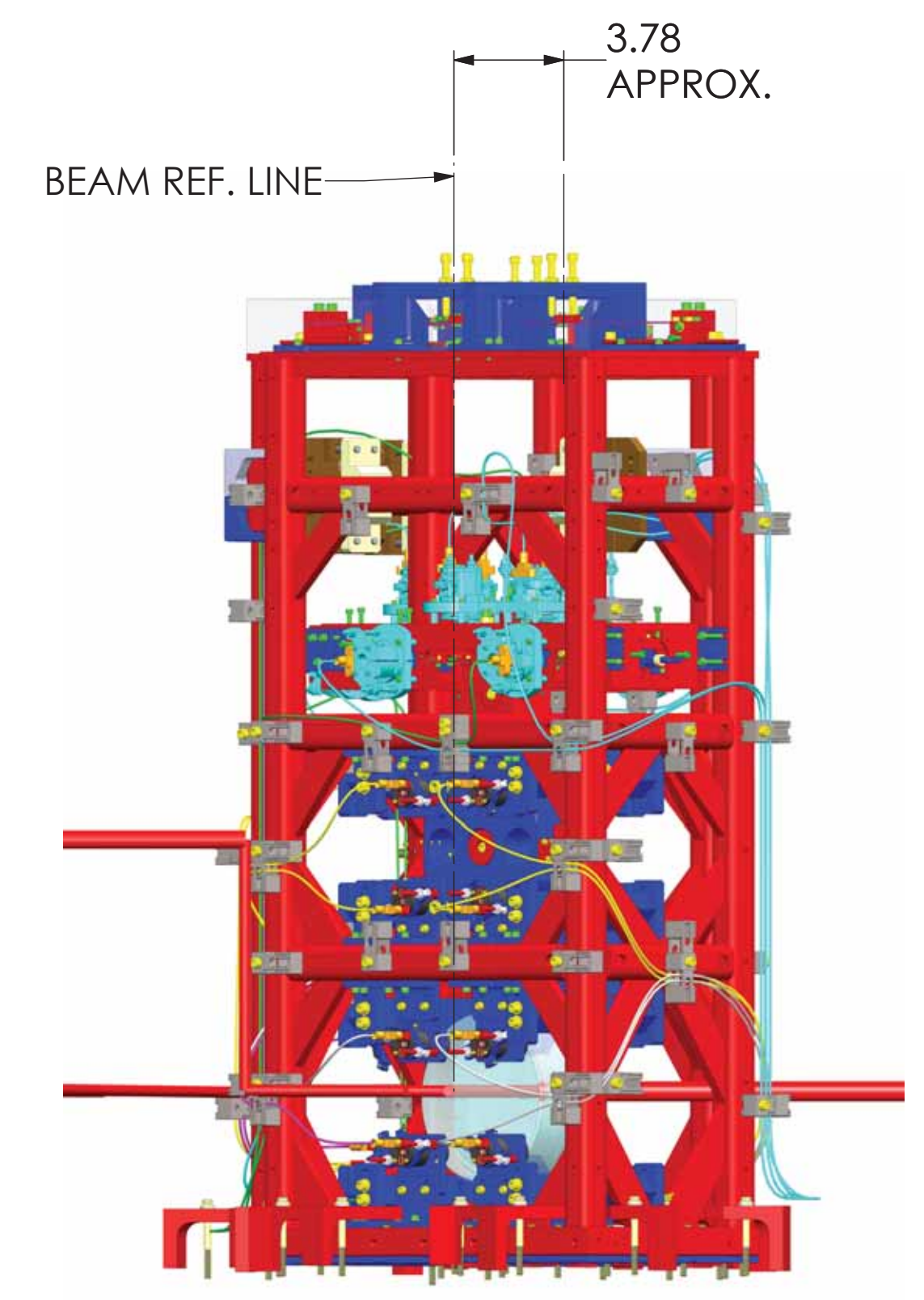

MC1 LHAM2
ISO VIEW, REAR RIGHT

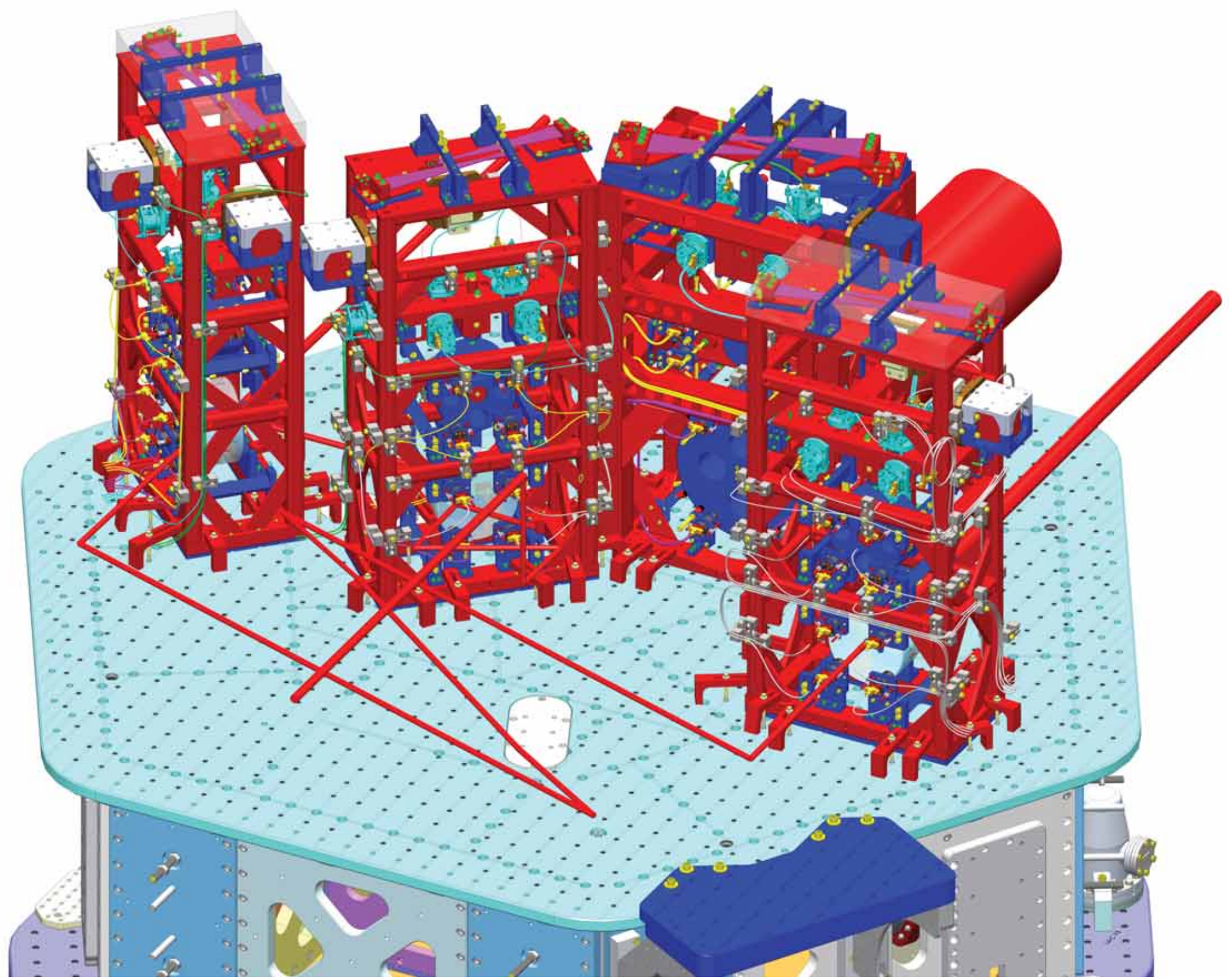

ISO VIEW, FRONT LEFT

LASER BEAMS AR SIDE CLEARANCES

LIGO CALIFORNIA INSTITUTE OF TECHNOLOGY MASSACHUSETTS INSTITUTE OF TECHNOLOGY	
SIZE DWG. NO.	REV.
D D0900365	v8
SCALE: NTS	PROJECTION:
SHEET 6 OF 6	

8 7 6 5 4 3 2 1

D:\D0900365_A04\LIGO Systems_HAM2\L1 Top Level Chamber Assembly_All Part PDM REV.: DRAWING PDM REV.: X014